

ITEM 096007 ESH-PRO

Description	Technical data	Accessories	Downloads
-------------	----------------	-------------	-----------

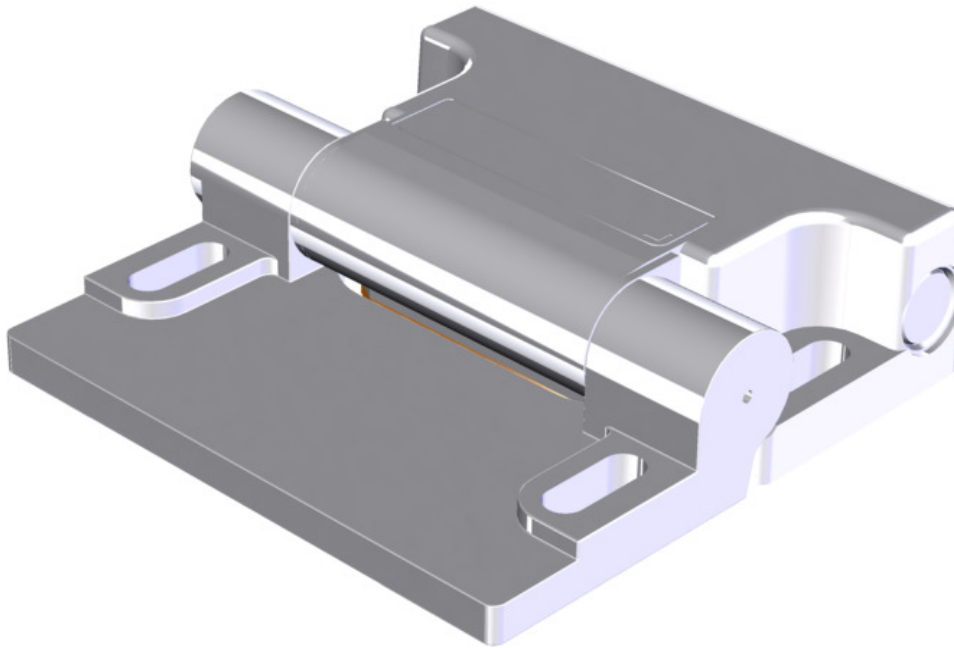







Approvals



Mechanical values and environment

Housing material	Die-cast zinc, nickel-plated
Weight	Net 0,7 kg

 EU-Konformitätserklärung

	Doc. no.	Version	Language	Download
EU-Konformitätserklärung	2097676	08-04/17		 0.2 MB
Declaración UE de conformidad				
Déclaration UE de conformité				
Dichiarazione di conformità				
EU declaration of conformity				

CAD data

CAD data for this item on TraceParts