

ITEM 098108 CES-A-BQA

Description	Technical data	Accessories	Downloads
-------------	----------------	-------------	-----------



Features

- › Cube-shaped design 50 x 50 mm
- › Two safety screws M4x14 included

Approvals



Mechanical values and environment

Housing material	Plastic (PPS)
Weight	Net 0,07 kg
Ambient temperature	-25 ... 70 °C
Degree of protection	IP67
Installation position	Active face opposite read head

Tightening torque

Fixing screws max.1 Nm

Electrical connection ratings

Power supply

Inductive via read head

Dimension drawing

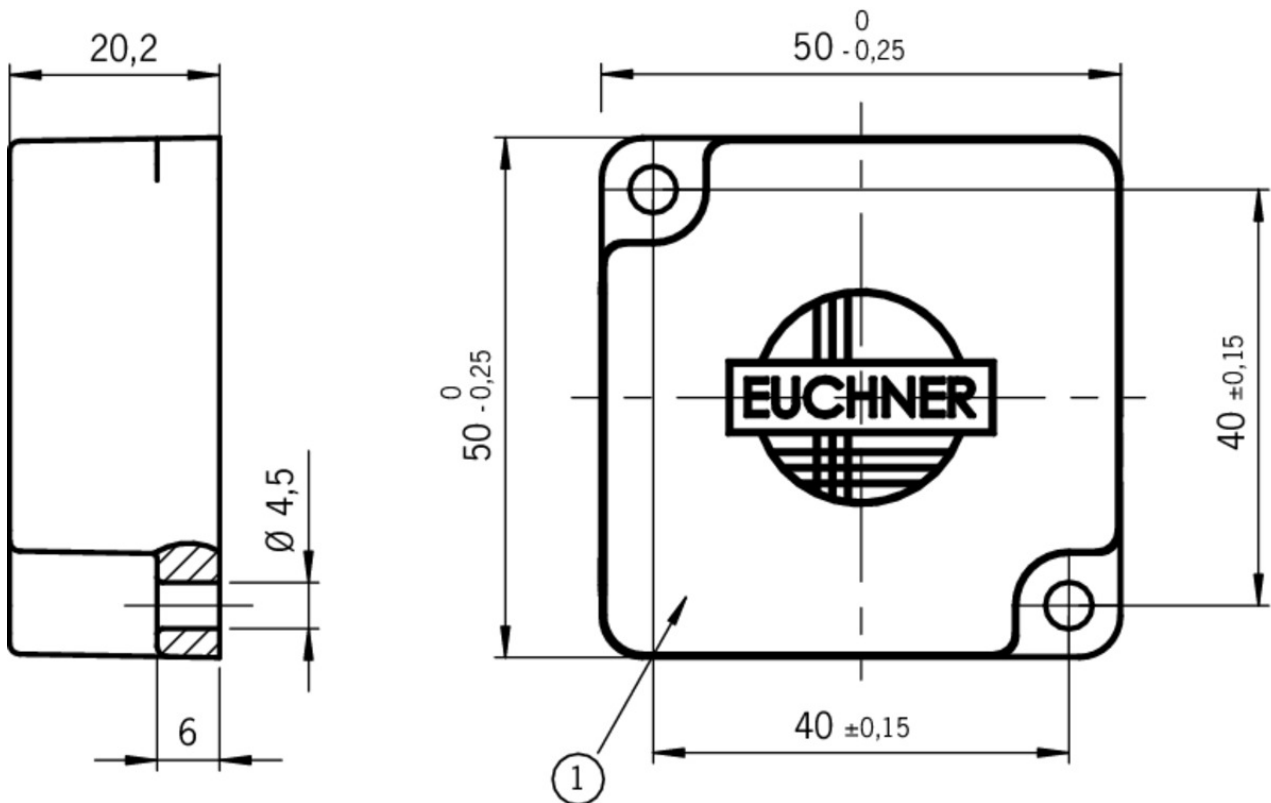

Legende

1 Active face

Mounting accessories

✓ Safety screws M4 x 14









071863 M4X14-CES/V20

✓ Features

- › Safety screws M4 x 14
- › Packaging unit 20 pieces

Catalogs

- Transpondercodierte Sicherheitssysteme mit externer Auswertung Transponder-coded safety systems with external evaluation Sistemas de seguridad con codificación por transponder y evaluación externa Systèmes de sécurité à codage par transpondeur avec analyse externe

	Doc. no.	Version	Language	Download
Transpondercodierte Sicherheitssysteme mit externer Auswertung	127596	02-01/18		 3.1 MB
Systèmes de sécurité à codage par transpondeur avec analyse externe	137968	02-01/18		 3.0 MB
Sistemas de seguridad con codificación por transponder y evaluación externa	139969	02-01/18		 3.0 MB
Transponder-coded safety systems with external evaluation	127597	02-01/18		 3.0 MB

CAD data

CAD data for this item on TraceParts