

ITEM 100251 CES-A-BRN-100251

Description	Technical data	Accessories	Downloads
-------------	----------------	-------------	-----------



Features

- › Cube-shaped design 80 x 40 mm

Approvals



Components included in the set

Supplied accessories

2x safety screws M5x16

Mechanical values and environment

Housing material	Plastic (PPS)
------------------	---------------

Weight	Net	0,06 kg
Ambient temperature		-25 ... 70 °C
Degree of protection		IP67
Mounting method		Surface mounting on steel
Installation position		Active face opposite read head
Tightening torque	Fixing screws	max.0,5 Nm

Electrical connection ratings

Power supply	Inductive via read head
--------------	-------------------------

Dimension drawing

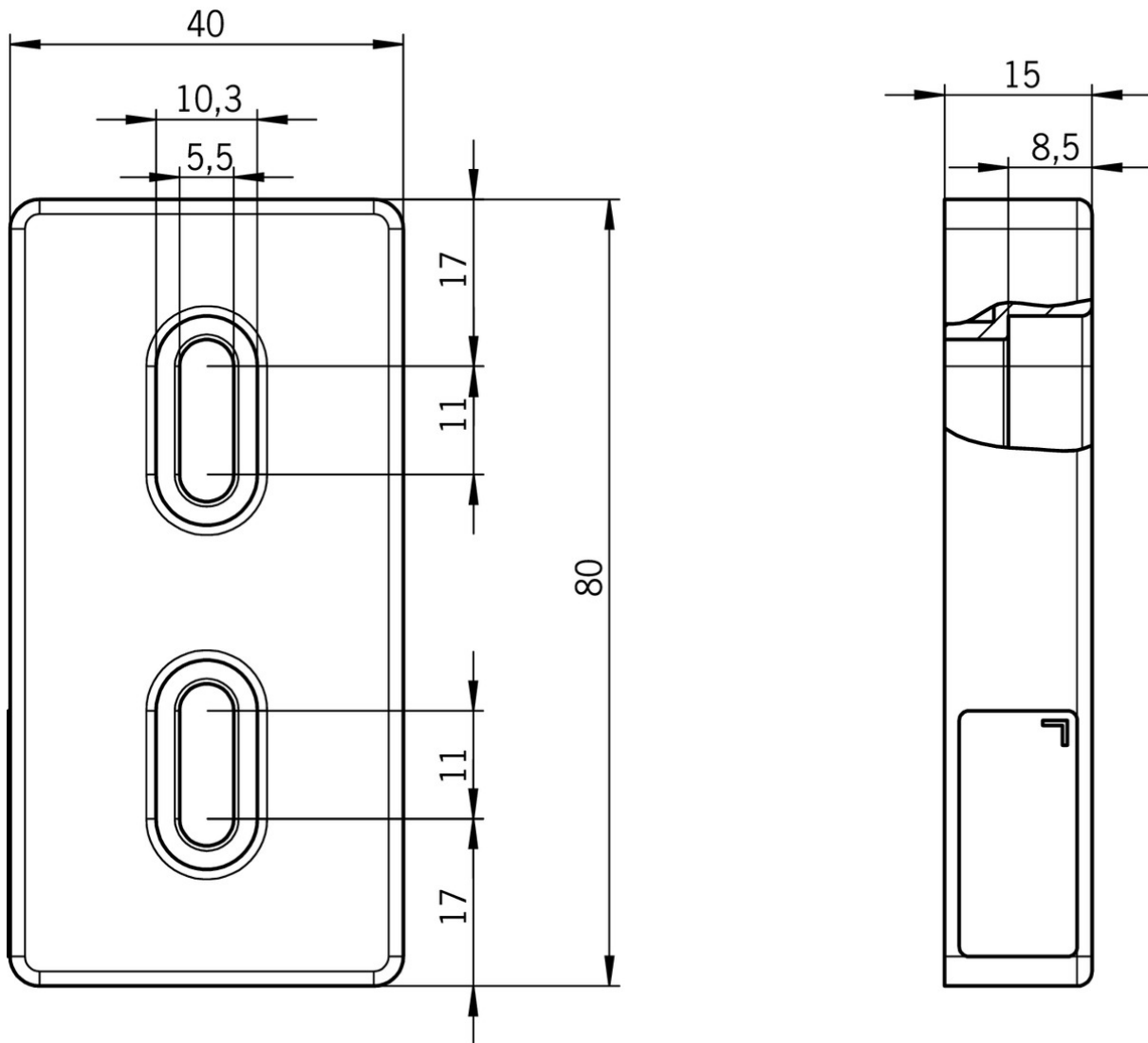

Mounting accessories

▼ Safety screws for actuators, M5 x 16









073456 M5X16/V100

▼ Features

- › Safety screws M5 x 16
- › Packaging unit 100 pieces

Catalogs

- ▼ Transpondercodierte Sicherheitsschalter - Verriegelungseinrichtungen und Zuhaltungen
Transponder-coded safety switches - Interlocking devices and guard locking devices
Interruptores de seguridad con codificación por transponder - Dispositivos de enclavamiento y bloqueos
Interrupteurs de sécurité à codage par transpondeur - Dispositifs de verrouillage et interverrouillages

	Doc. no.	Version	Language	Download
Transpondercodierte Sicherheitsschalter - Verriegelungseinrichtungen und Zuhaltungen	127594	02-01/18		 5.2 MB
Interrupteurs de sécurité à codage par transpondeur - Dispositifs de verrouillage et interverrouillages	137558	02-01/18		 5.2 MB
Interruptores de seguridad con codificación por transponder - Dispositivos de enclavamiento y bloqueos	137560	02-01/18		 5.2 MB
Transponder-coded safety switches - Interlocking devices and guard locking devices	127595	02-01/18		 5.1 MB

CAD data

CAD data for this item on TraceParts