

## ITEM 106600 CES-A-BBN-106600

Description	Technical data	Accessories	Downloads
-------------	----------------	-------------	-----------



### Features

- › Cube-shaped design 42 x 25 mm
- › Attachment compatible with actuator CES-A-BBA/BCA

### Approvals



### Mechanical values and environment

Housing material	Reinforced thermoplastic (PBT), fully encapsulated
Weight	Net 0,025 kg
Ambient temperature	-25 ... 70 °C
Degree of protection	IP67
Installation position	Active face opposite read head

Tightening torque

max.1 Nm

## Electrical connection ratings

Power supply

Inductive via read head

## Dimension drawing

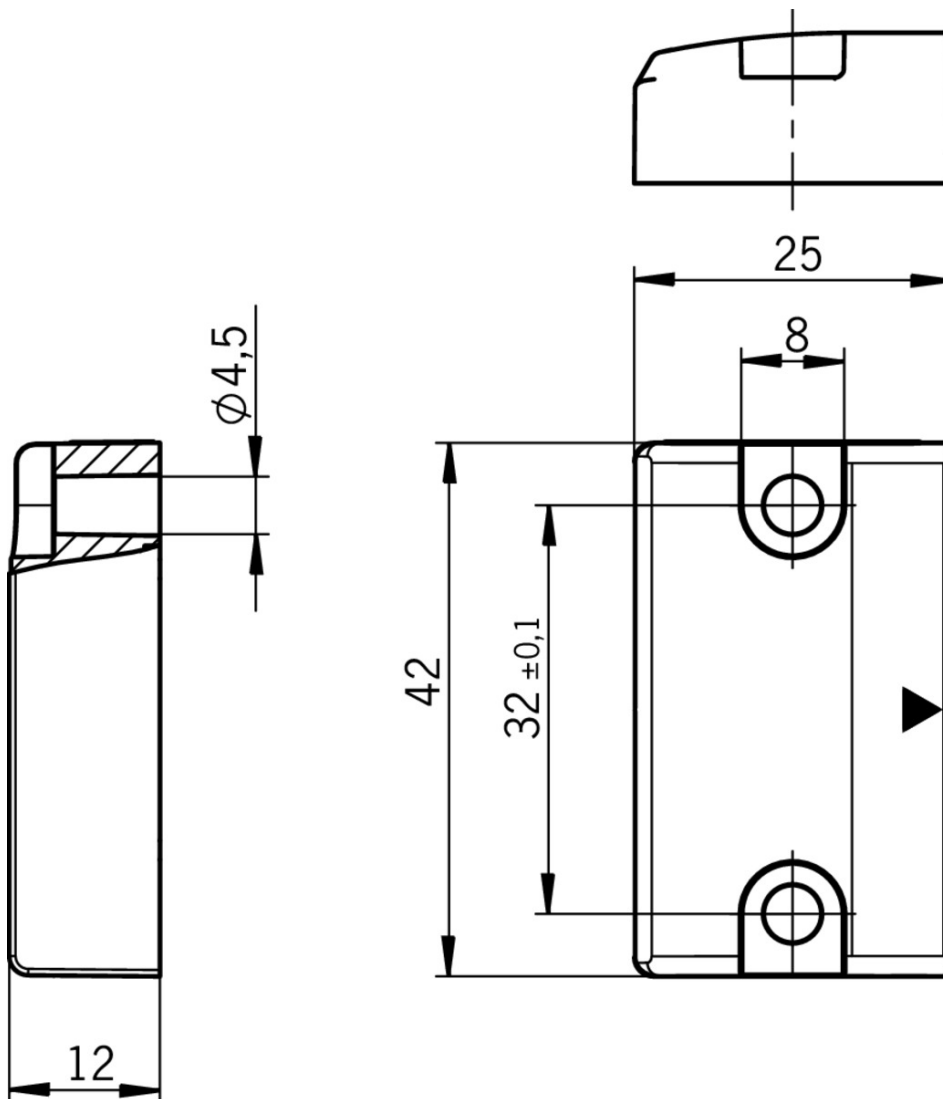

## Mounting accessories

☑ Safety screws M4 x 14









**071863** M4X14-CES/V20

☑ Features

- › Safety screws M4 x 14
- › Packaging unit 20 pieces

## Catalogs

-  Transpondercodierte Sicherheitssysteme mit externer Auswertung Transponder-coded safety systems with external evaluation Sistemas de seguridad con codificación por transponder y evaluación externa Systèmes de sécurité à codage par transpondeur avec analyse externe

	Doc. no.	Version	Language	Download
Transpondercodierte Sicherheitssysteme mit externer Auswertung	127596	02-01/18		 3.1 MB
Systèmes de sécurité à codage par transpondeur avec analyse externe	137968	02-01/18		 3.0 MB
Sistemas de seguridad con codificación por transponder y evaluación externa	139969	02-01/18		 3.0 MB
Transponder-coded safety systems with external evaluation	127597	02-01/18		 3.0 MB

## CAD data

CAD data for this item on TraceParts