

## ITEM 112989 MGB-A-EMERGENCYRELEASE-112989

Description	Technical data	Accessories	Downloads
-------------	----------------	-------------	-----------

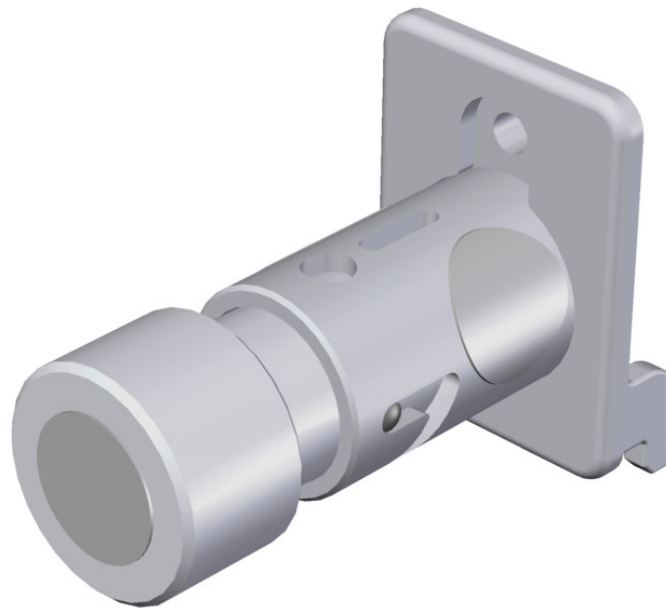

### Features

- › Quick emergency unlocking
- › sealable

The MGB can be unlocked manually using the emergency unlocking. The rotary knob is pushed and then turned by 90° to unlock. The snap-in bolt engages in the hole on the flange. To release the emergency unlocking, push the snap-in bolt inward and simultaneously turn the rotary knob back to its initial position. The emergency unlocking can be sealed in free position. Wire and seal are included with the emergency unlocking.

### Approvals



### Mechanical values and environment

Material	Aluminum, stainless steel
Weight	

Net 0,04 kg

Mechanical life

$0,02 \times 10^6$

### Dimension drawing

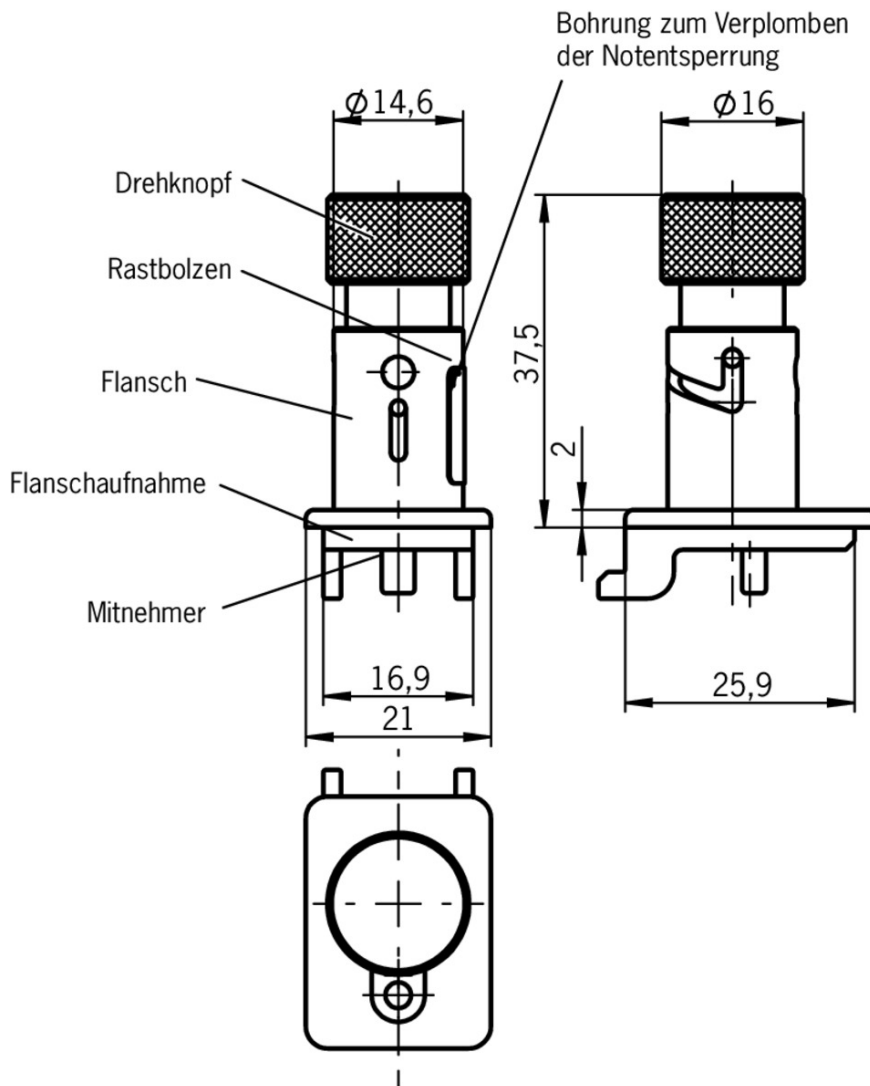













### Spare parts

Lead seal kit

**087256** PLOMBENSATZ C1937

### Catalogs

▼ Multifunctional Gate Box MGB Multifunctional Gate Box MGB Multifunctional Gate Box MGB  
Multifunctional Gate Box MGB Multifunctional Gate Box MGB 多功能系统安全控制系统 MGB

	<b>Doc. no.</b>	<b>Version</b>	<b>Language</b>	<b>Download</b>
Multifunctional Gate Box MGB	106108	10-02/18		 8.2 MB
Multifunctional Gate Box MGB	109155	10-02/18		 8.2 MB
Multifunctional Gate Box MGB	114433	10-02/18		 8.3 MB
Multifunctional Gate Box MGB	121652	10-02/18		 8.0 MB
Multifunctional Gate Box MGB	106109	10-02/18		 8.2 MB
多功能系统安全控制系统 MGB	155883	10-02/18		 8.3 MB