

## ITEM 028357 RIEGEL NZ/TZ-S1

Description	Technical data	Accessories	Downloads
-------------	----------------	-------------	-----------



### Features

- › Aluminum bolt
- › For doors hinged on the left or right. Cone grip bottom.
- › Spring catch in open position
- › Can be locked in open position with padlocks
- › Actuator included

### Advantages

- › Robust construction
- › Easy screw mounting
- › No additional door handle necessary

### Special features

- › On bolt **NZ/TZ-S1**, actuating pin on bottom
- › After the door is opened, the actuator is automatically withdrawn into the bolt by a built-in return spring.
  - › The operator is protected. When the door is open there is no risk of injury due to protruding actuator.
  - › The actuator is protected. When hinged doors are closed it is ensured

that the actuator is not used as an end stop.

### **Mechanical values and environment**

Material	Handle	Plastic
	Housing	Aluminum
	Sliding	Aluminum
Weight	Net	1 kg
Escape release		No

### **Miscellaneous**

Detent mechanism	No
------------------	----

### **Dimension drawing**

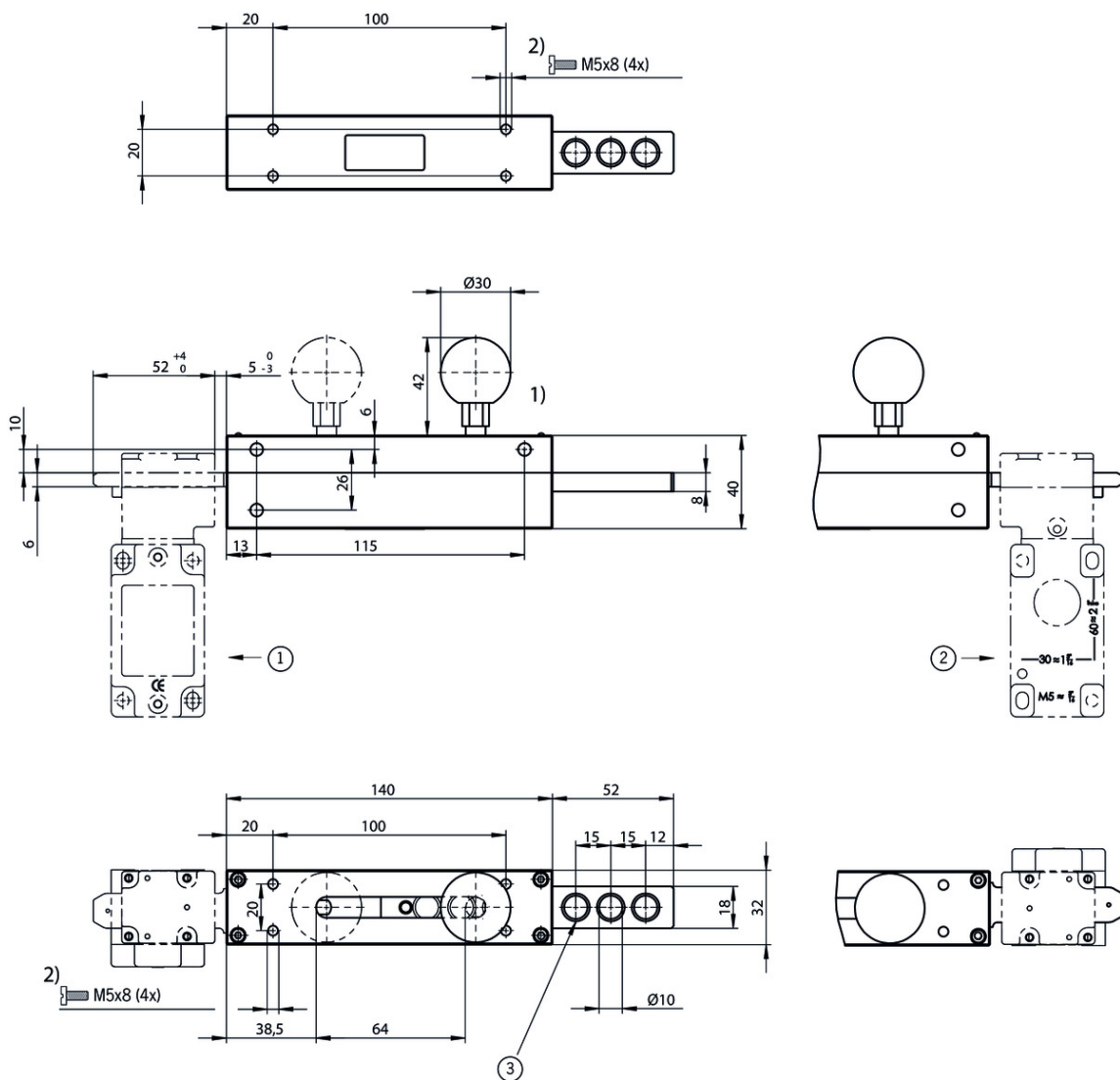













## Legende

Additional information: For setup or setting the approach direction the handle must be securely bonded in the thread. Removing the handle with the system in operation is not

- 1) allowed for reasons related to protection against tampering. Safety switch and actuator (bolt) must be combined correctly for mounting. Do not use safety switch as an end stop for the safety guard.
- 2) Bolt fastening
- 1 Safety switch NZ.VZ approach direction A
- 2 Safety switch NZ.VZ approach direction C
- 3 Hole for 3 padlocks

## Catalogs

- ▼
 Sicherheitsschalter mit Metallgehäuse Safety Switches with Metal Housing Bezpečnostní spínače s kovovým pouzdrém Interrupteurs de sécurité avec boîtier métallique 金属壳体的安全开关 Interruptores de seguridad con carcasa metálica

	<b>Doc. no.</b>	<b>Version</b>	<b>Language</b>	<b>Download</b>
Sicherheitsschalter mit Metallgehäuse	100319	11-03/18		 7.9 MB
Interrupteurs de sécurité avec boîtier métallique	100676	11-03/18		 7.9 MB
Interruptores de seguridad con carcasa metálica	104856	11-03/18		 14.0 MB
Safety Switches with Metal Housing	100369	11-03/18		 7.9 MB
Bezpečnostní spínače s kovovým pouzdem	121650	11-03/18		 7.9 MB
金属壳体 的安全开关	102453	11-03/18		 8.2 MB