

## ITEM 084430 RIEGEL TP-A

Description	Technical data	Accessories	Downloads
-------------	----------------	-------------	-----------



### Features

- › Steel bolt
- › For doors hinged on the right
- › Can be locked in open position with padlocks
- › Actuator included

### Advantages

- › Robust construction
- › Easily fitted to standard aluminum profiles and machine covers by screw connection
- › Distinctive yellow color for easy recognition
- › No additional door handle necessary
- › Actuator included

### Notes

- › The bolts are suitable for the series **TP...A** and **GP**
- › Order safety switch separately

## Mechanical values and environment

Material		
	Handle	Plastic
	Guide strips	Plastic
	Base plate	Galvanized steel
	Switch bracket	Steel powder-coated
Weight		
	Net	2 kg
Escape release		No
Number of safety switches that can be fitted		1

## Miscellaneous

Detent mechanism		No
------------------	--	----

## Dimension drawing

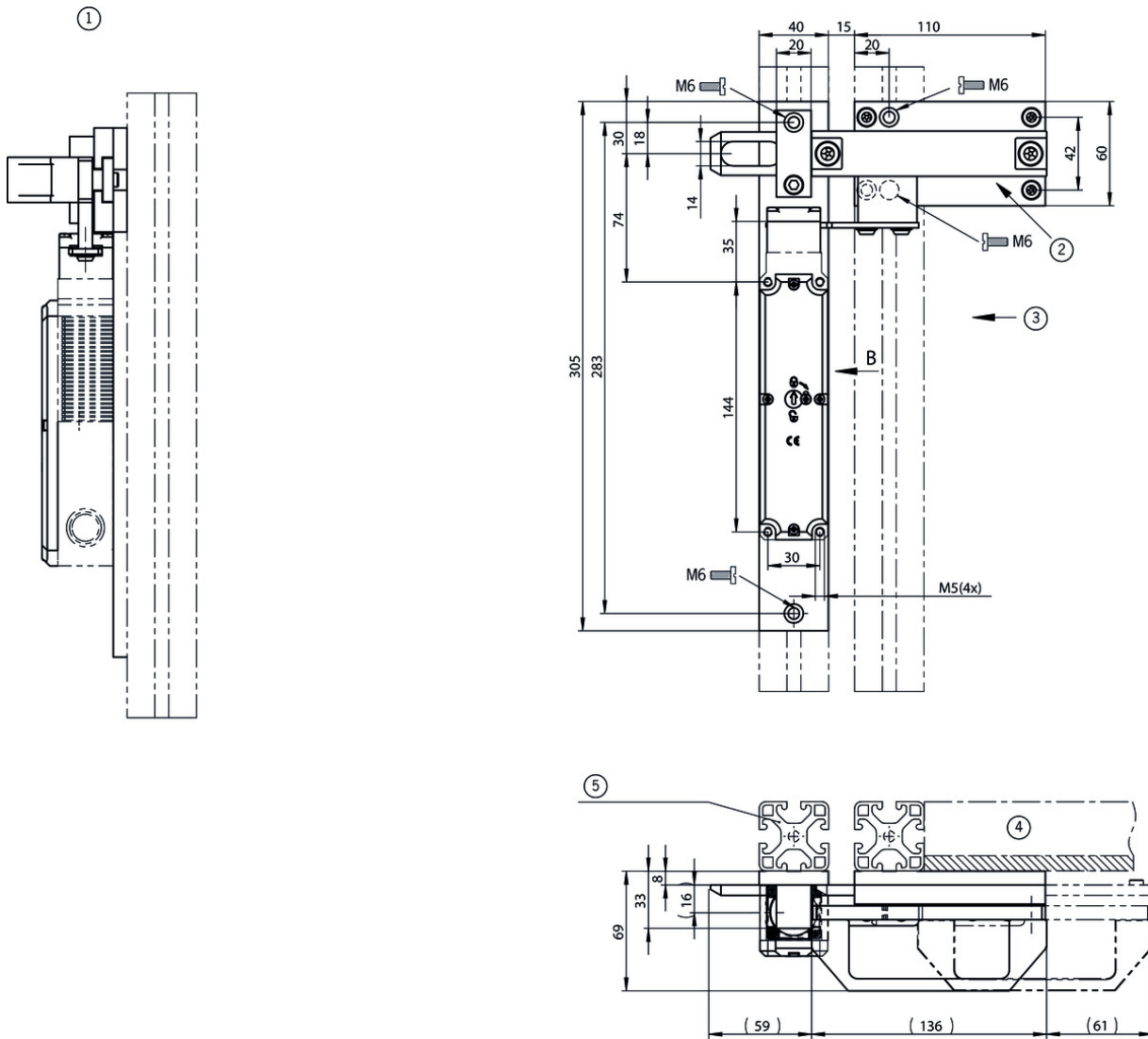













## Legende

- 1 View B
- 2 Attention! Bolt is not allowed to be used in conjunction with an escape release!
- 3 Safety switch TP approach direction A
- 4 Door hinged on the right
- 5 Safety guard frame (40x40)

## Catalogs

- ▼ Bezpečnostní spínače s plastovým pouzdrém Sicherheitsschalter mit Kunststoffgehäuse Safety Switches with Plastic Housing Interruptores de seguridad con carcasa plástica Interrupteurs de sécurité avec boîtier plastique 塑料壳体的安全开关

	Doc. no.	Version	Language	Download
Sicherheitsschalter mit Kunststoffgehäuse	096955	11-03/18		 6.6 MB
Interrupteurs de sécurité avec boîtier plastique	100677	11-03/18		 6.6 MB
Interruptores de seguridad con carcasa plástica	104855	11-03/18		 6.6 MB
Bezpečnostní spínače s plastovým pouzdem	121649	11-03/18		 6.6 MB
Safety Switches with Plastic Housing	096956	11-03/18		 6.6 MB
塑料壳体 的安全开关	116243	11-03/18		 6.2 MB

### CAD data

CAD data for this item on TraceParts