

ITEM 085393 RIEGEL TX-CF

Description	Technical data	Accessories	Downloads
-------------	----------------	-------------	-----------

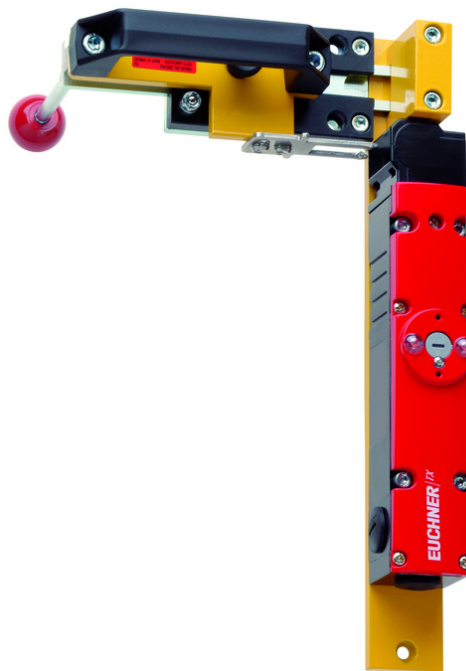

Features

- › Steel bolt
- › For safety switches with escape release **TX...C1991 + 2161**
- › For doors hinged on the left
- › Detent knob in open position
- › Can be locked in open position with padlocks
- › Actuator and switch bracket included

Advantages

- › Robust construction
- › Easily fitted to standard aluminum profiles and machine covers by screw connection
- › Distinctive yellow color for easy recognition
- › No additional door handle necessary

Mechanical values and environment

Material

	Handle	Plastic
	Guide strips	Plastic
	Base plate	Galvanized steel
	Switch bracket	Steel powder-coated
Weight		
	Net	2,25 kg
Escape release		Yes
Number of safety switches that can be fitted		1

Miscellaneous

Detent mechanism		
	Open position	Bolt detent mechanism

Dimension drawing

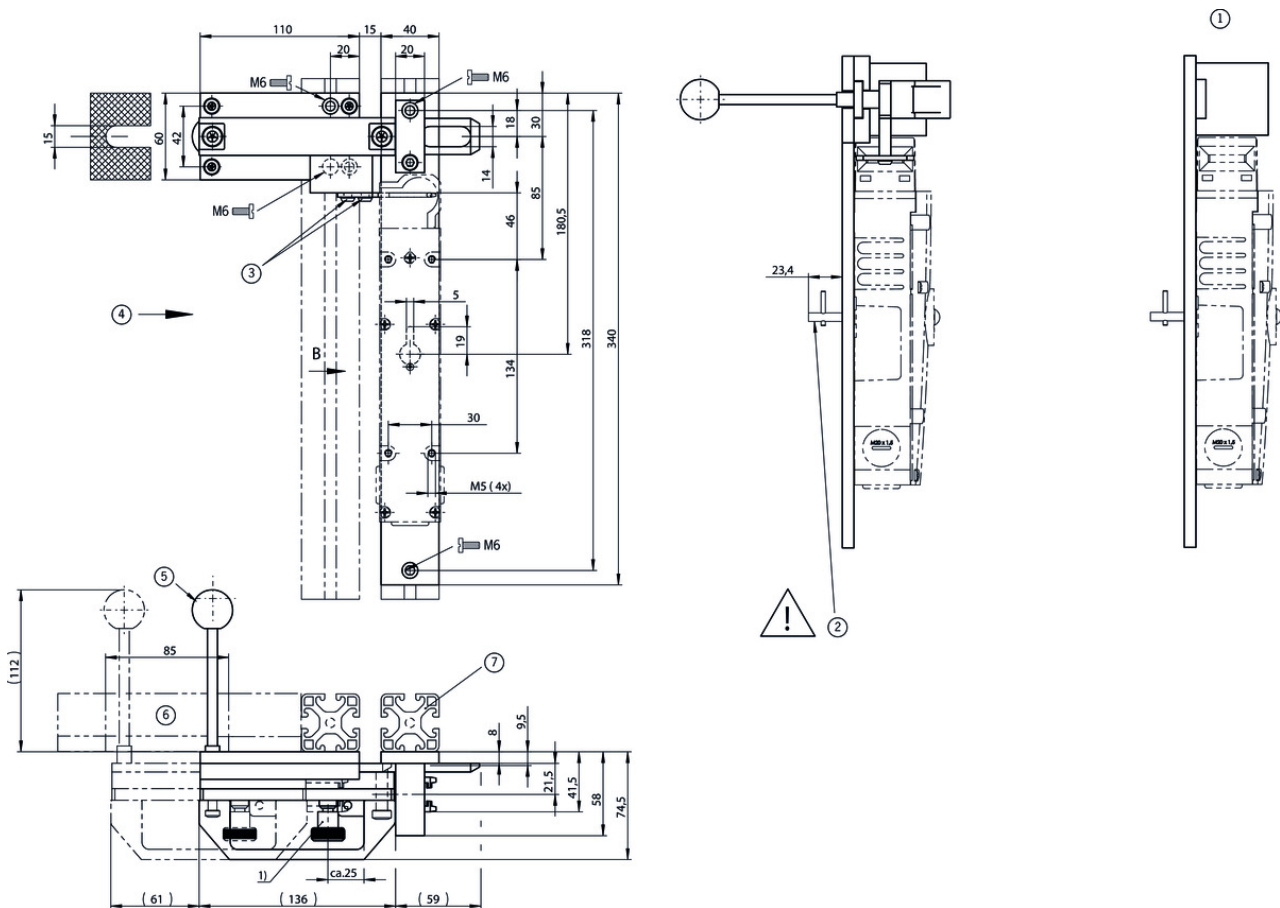

Legende

- 1 View B
- 2 On the actuation of the escape release for the switch, the actuator must not be subjected to a tensile load (e.g. due to strain on the doors or pulling the lever on the bolt)
- 3 Safety screw
- 4 Safety switch TX approach direction C
- 5 Included loose
- 6 Door hinged on the left
- 7 Safety guard frame (40x40)
- 1) Bolt with detent mechanism. Engages in open position. (Prevents unintentional closing of the bolt) Unlocked by pulling the detent knob upward.

Spare parts

- ▼ Replacement handle for EUCHNER bolts



093500 RIEGELGRIFF/V5













- ▼ Features

- › Material: plastic, reinforced polypropylene (PP)
- › Color: black, mat

- › Temperature resistance up to 100 °C
- › Packaging unit 5 pieces

Catalogs

- ▼ Sicherheitsschalter mit Metallgehäuse Safety Switches with Metal Housing Bezpečnostní spínače s kovovým pouzdem Interrupteurs de sécurité avec boîtier métallique 金属壳体 的安全开关 Interruptores de seguridad con carcasa metálica

	Doc. no.	Version	Language	Download
Sicherheitsschalter mit Metallgehäuse	100319	11-03/18		 7.9 MB
Interrupteurs de sécurité avec boîtier métallique	100676	11-03/18		 7.9 MB
Interruptores de seguridad con carcasa metálica	104856	11-03/18		 14.0 MB
Safety Switches with Metal Housing	100369	11-03/18		 7.9 MB
Bezpečnostní spínače s kovovým pouzdem	121650	11-03/18		 7.9 MB
金属壳体 的安全开关	102453	11-03/18		 8.2 MB

CAD data

CAD data for this item on TraceParts