

ITEM 097955 RIEGEL CEM-A

Description	Technical data	Accessories	Downloads
-------------	----------------	-------------	-----------



Features

- › In combination with read head CEM-A-LE05...
- › Steel bolt
- › For doors hinged on the right
- › Can be locked in open position with padlocks

Advantages

- › Easily fitted to standard aluminum profiles and machine covers by screw connection
- › Distinctive yellow color for easy recognition
- › Symmetrical design for doors hinged on the right or left
- › No additional door handle necessary

Notes

- › Order read head, actuator and evaluation unit separately
- › Other bolt types (e.g. with mechanical detent mechanism in closed bolt position) on request

Special features

- › Easy read head mounting
- › Uniquely coded actuator (one-off)- maximum protection against tampering

Mechanical values and environment

Material	Handle	Plastic
	Guide strips	Plastic
	Base plate	Galvanized steel
	Switch bracket	Steel powder-coated
Weight	Net	2,25 kg
	Escape release	No
Number of safety switches that can be fitted		1

Miscellaneous

Detent mechanism	No
------------------	----

Dimension drawing

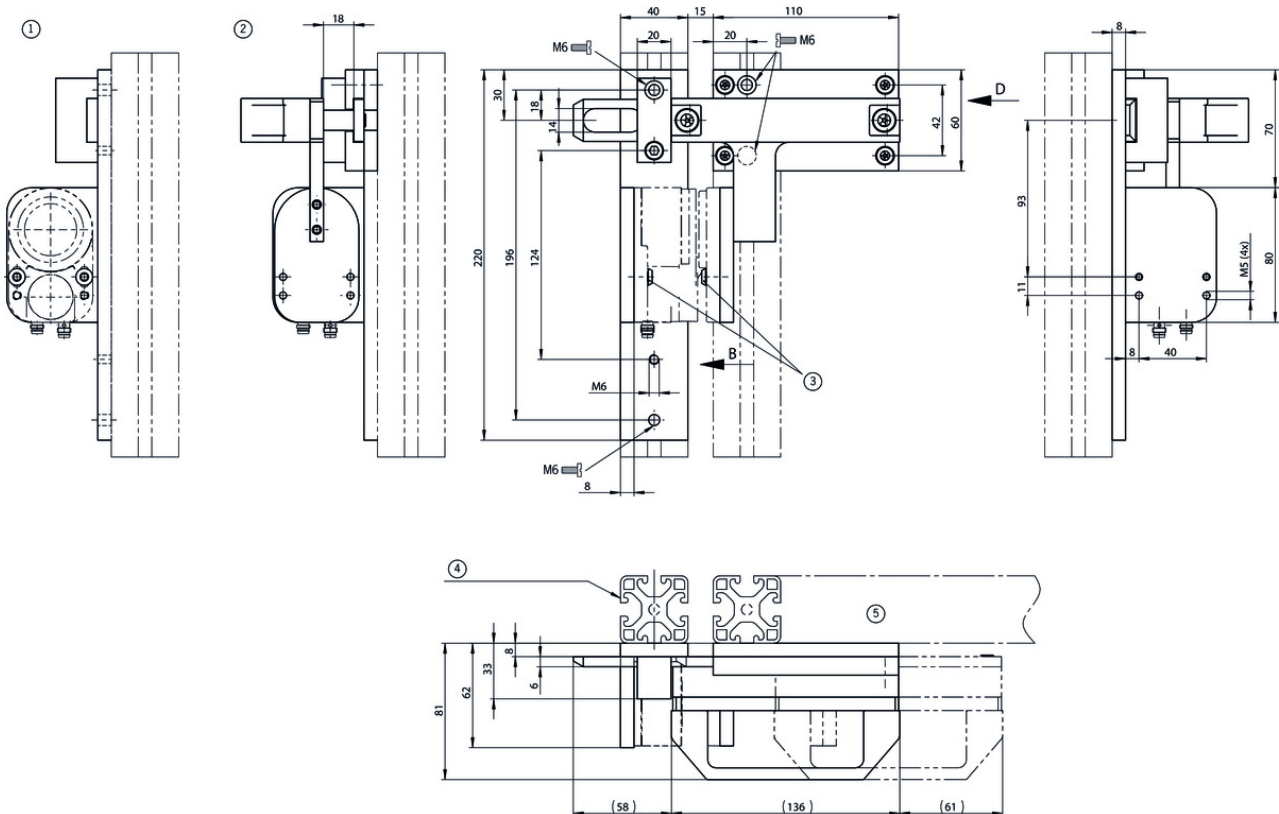

Legende

- 1 View B
- 2 View D
- 3 4 safety screws included for mounting.
- 4 Safety guard frame (40x40)
- 5 Door hinged on the right

Spare parts

- ✓ Replacement handle for EUCHNER bolts











093500 RIEGELGRIFF/V5

✓ Features

- › Material: plastic, reinforced polypropylene (PP)
- › Color: black, mat
- › Temperature resistance up to 100 °C
- › Packaging unit 5 pieces

Catalogs

- Transpondercodierte Sicherheitssysteme mit externer Auswertung Transponder-coded safety systems with external evaluation Sistemas de seguridad con codificación por transponder y evaluación externa Systèmes de sécurité à codage par transpondeur avec analyse externe

	Doc. no.	Version	Language	Download
Transpondercodierte Sicherheitssysteme mit externer Auswertung	127596	02-01/18		 3.1 MB
Systèmes de sécurité à codage par transpondeur avec analyse externe	137968	02-01/18		 3.0 MB
Sistemas de seguridad con codificación por transponder y evaluación externa	139969	02-01/18		 3.0 MB
Transponder-coded safety systems with external evaluation	127597	02-01/18		 3.0 MB

CAD data

CAD data for this item on TraceParts