

ITEM 093458 EMP-B2

Description	Technical data	Accessories	Downloads
-------------	----------------	-------------	-----------



The mounting plates are used for fastening actuators to safety guards. The safety switches can be attached vertically and horizontally.

Notice

- › Mounting plate material: galvanized St37.

Mechanical values and environment

Material	Galvanized steel
Weight	Net 0,1 kg

Dimension drawing

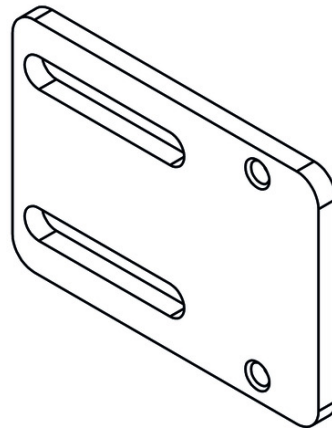
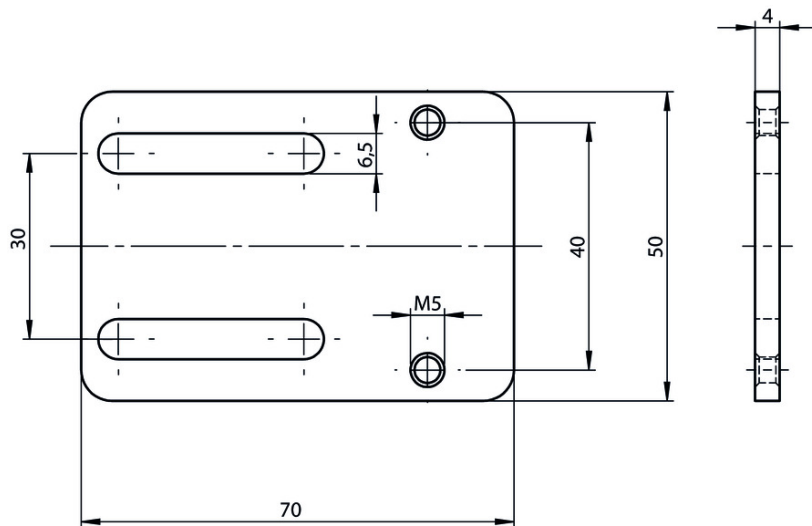

Actuator

- ▼ Hinged actuator S left/right for safety switches SGA/SGP/STA/STP/STM



096838 RADIUSBETAETIGER-S-LR-SN

▼ Features

- › Actuators made of stainless steel
- › Two safety screws included
- › For doors hinged on right and left

- ▼ Hinged actuator L left/right, for safety switches SGA/SGP/STA/STP/STM for insertion funnel



096844 RADIUSBETAETIGER-S-LR-LN

▼ Features

- › Actuators made of stainless steel
- › Two stainless safety screws per actuator
- › For doors hinged on right and left

- ▼ Hinged actuator top/bottom for safety switches NP/GP/TP



070050 RADIUSBETAETIGER-P-OU

▼ Features

- › Actuators made of stainless steel
- › Two stainless safety screws per actuator
- › For doors hinged at top and bottom

- ▼ Hinged actuator top/bottom for safety switches NX/TX



097906 RADIUSBETAETIGER-X-OU-N

▼ Features

- › Actuators made of stainless steel
- › Two stainless safety screws per actuator

- ▼ Hinged actuator top for safety switches NZ.VZ, NZ.VZ.VS and TZ



057950 RADIUSBETAETIGER-Z-O

▼ Features

- › Two stainless safety screws per actuator

- ▼ Hinged actuator bottom for safety switches NZ.VZ, NZ.VZ.VS and TZ



048850 RADIUSBETAETIGER-Z-U

▼ Features

- › Two stainless safety screws per actuator

- ▼ Hinged actuator top/bottom for safety switches NP/GP/TP, increased overtravel



074572 RADIUSBETAETIGER-P-OUN

▼ Features

- › Actuators made of stainless steel
- › Two stainless safety screws per actuator
- › For doors hinged at top and bottom













Catalogs

- ▼ Transpondercodierte Sicherheitsschalter - Verriegelungseinrichtungen und Zuhaltungen
Transponder-coded safety switches - Interlocking devices and guard locking devices
Interruptores de seguridad con codificación por transponder - Dispositivos de enclavamiento y bloqueos
Interrupteurs de sécurité à codage par transpondeur - Dispositifs de verrouillage et interverrouillages













	Doc. no.	Version	Language	Download
Transpondercodierte Sicherheitsschalter - Verriegelungseinrichtungen und Zuhaltungen	127594	02-01/18		5.2 MB

Interrupteurs de sécurité à codage par transpondeur - Dispositifs de verrouillage et interverrouillages	137558	02-01/18		 5.2 MB
Interruptores de seguridad con codificación por transponder - Dispositivos de enclavamiento y bloqueos	137560	02-01/18		 5.2 MB
Transponder-coded safety switches - Interlocking devices and guard locking devices	127595	02-01/18		 5.1 MB

Bezpečnostní spínače s plastovým pouzdem Sicherheitsschalter mit Kunststoffgehäuse Safety Switches with Plastic Housing Interruptores de seguridad con carcasa plástica Interrupteurs de sécurité avec boîtier plastique 塑料壳体 的安全开关

	Doc. no.	Version	Language	Download
Sicherheitsschalter mit Kunststoffgehäuse	096955	11-03/18		 6.6 MB
Interrupteurs de sécurité avec boîtier plastique	100677	11-03/18		 6.6 MB
Interruptores de seguridad con carcasa plástica	104855	11-03/18		 6.6 MB
Bezpečnostní spínače s plastovým pouzdem	121649	11-03/18		 6.6 MB
Safety Switches with Plastic Housing	096956	11-03/18		 6.6 MB
塑料壳体 的安全开关	116243	11-03/18		 6.2 MB

Sicherheitsschalter mit Metallgehäuse Safety Switches with Metal Housing Bezpečnostní spínače s kovovým pouzdem Interrupteurs de sécurité avec boîtier métallique 金属壳体 的安全开关 Interruptores de seguridad con carcasa metálica

	Doc. no.	Version	Language	Download
Sicherheitsschalter mit Metallgehäuse	100319	11-03/18		 7.9 MB
Interrupteurs de sécurité avec boîtier métallique	100676	11-03/18		 7.9 MB
Interruptores de seguridad con carcasa metálica	104856	11-03/18		 14.0 MB
Safety Switches with Metal Housing	100369	11-03/18		 7.9 MB
Bezpečnostní spínače s kovovým pouzdem	121650	11-03/18		 7.9 MB
金属壳体 的安全开关	102453	11-03/18		 8.2 MB

CAD data

CAD data for this item on TraceParts