

ITEM 094401 EMP-SA

Description	Technical data	Accessories	Downloads
-------------	----------------	-------------	-----------

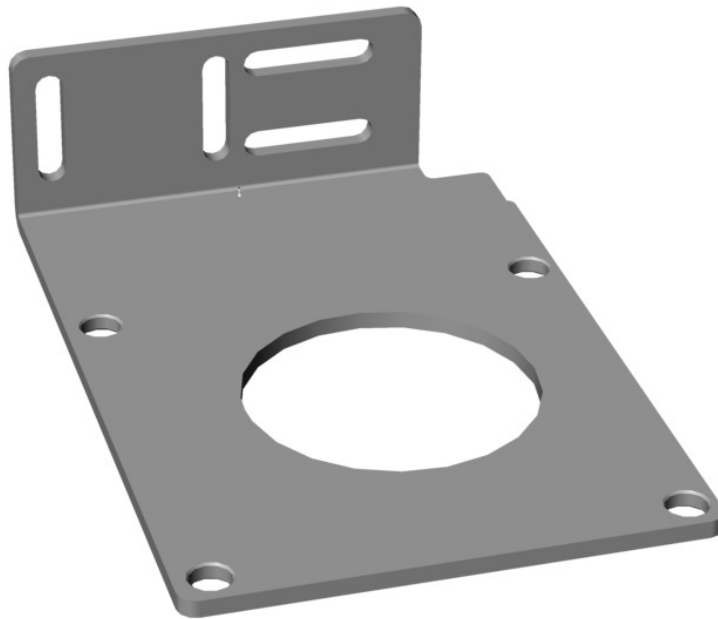

Features

- › For vertical and horizontal mounting of safety switch TZ

The mounting plates are used for fastening safety switches TZ to safety guards. The safety switches can be attached vertically and horizontally. The mounting plate EMP-SA is also suitable for safety switches with escape release from the rear.

Notice

- › Mounting plate material: galvanized St37.
- › The mounting plate EMP-SA is also suitable for the safety switches TZ...C1684, TZ...C1815 and TZ...C1828 with escape release from the rear.

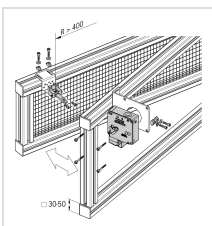

- › Installation example, safety switch vertical

Mechanical values and environment

Material	Galvanized steel
Weight	Net 0,6 kg

Dimension drawing

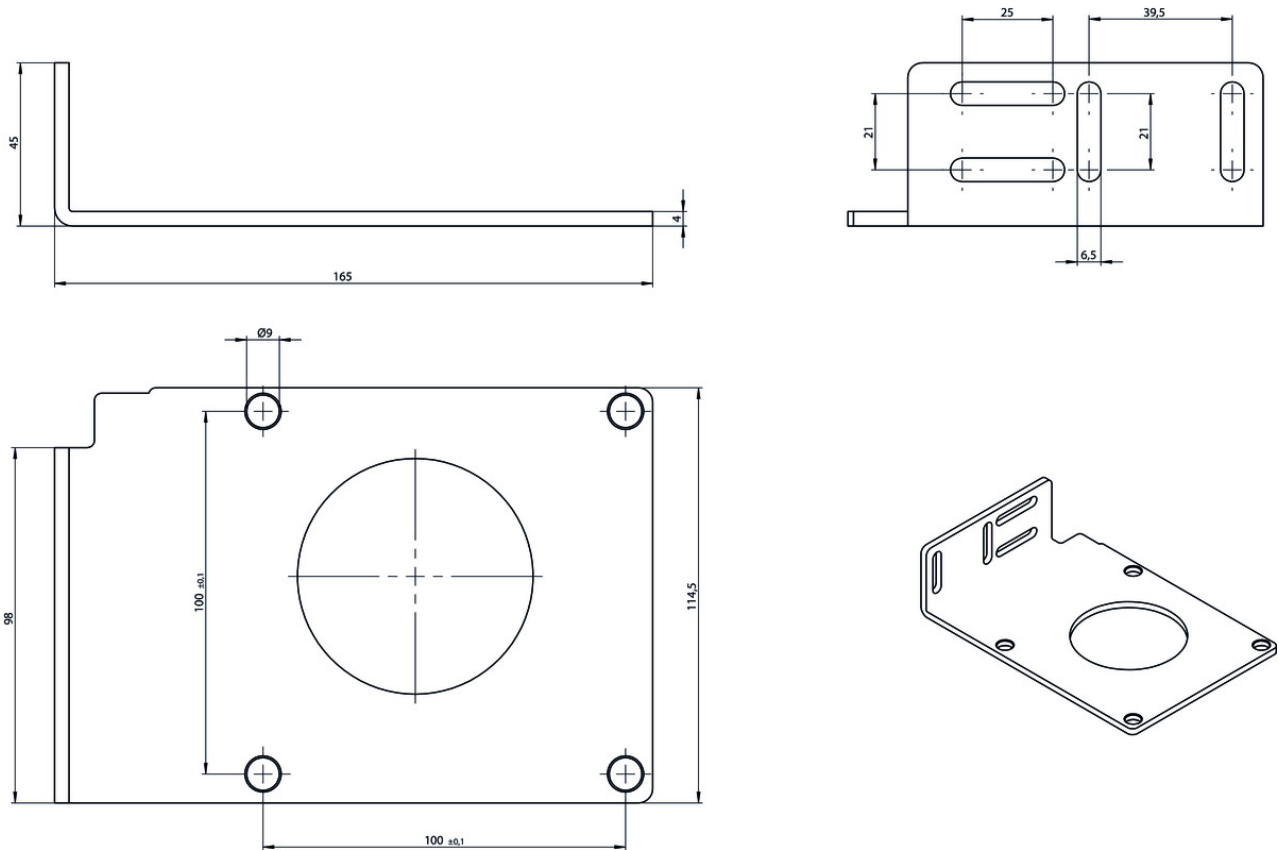

Mounting accessories

- ✓ Mounting plates EMP-B1 for actuators for safety switches CTP, TP...A, STA, STP, TX and TZ



093457 EMP-B1













- ✓ Mounting plates EMP-B2 for actuators for safety switches CTP, TP...A, STA, STP, TX and TZ



093458 EMP-B2

Catalogs

- ✓ Sicherheitsschalter mit Metallgehäuse Safety Switches with Metal Housing Bezpečnostní spínače s kovovým pouzdem Interrupteurs de sécurité avec boîtier métallique 金属壳体 的安全开关 Interruptores de seguridad con carcasa metálica

	Doc. no.	Version	Language	Download
Sicherheitsschalter mit Metallgehäuse	100319	11-03/18		 7.9 MB
Interrupteurs de sécurité avec boîtier métallique	100676	11-03/18		 7.9 MB
Interruptores de seguridad con carcasa metálica	104856	11-03/18		 14.0 MB
Safety Switches with Metal Housing	100369	11-03/18		 7.9 MB
Bezpečnostní spínače s kovovým pouzdem	121650	11-03/18		 7.9 MB
金属壳体 的安全开关	102453	11-03/18		 8.2 MB

CAD data

CAD data for this item on TraceParts