

ITEM 106285 BTC-ST/G-S-TH-01-F

Description	Technical data	Accessories	Downloads
-------------	----------------	-------------	-----------



Features

- › Aluminum bolt
- › For doors hinged on the left or right
- › Lever for escape release from the danger area
- › Pushbutton in open position
- › Can be locked in open position with padlocks
- › Actuator included

Advantages

- › Robust construction
- › Easily fitted to standard aluminum profiles and machine covers by screw connection
- › Distinctive yellow color for easy recognition
- › No additional door handle necessary

Notes

- › The bolts are suitable for series **STA, STP, SGP and SGA**
- › Order safety switch separately

Special features

- › Bolt with detent mechanism
- › The bolt latches in open position to prevent unintentional closing of the bolt.
Unlocked by pressing the knob.

Mechanical values and environment

Material	Handle	Aluminum
	Guide strips	Aluminum
	Base plate	Aluminum
	Switch bracket	Aluminum
Weight	Net	1 kg
	Escape release	Yes
Number of safety switches that can be fitted		1

Miscellaneous

Detent mechanism	Open position	Bolt detent mechanism
------------------	---------------	-----------------------

Dimension drawing

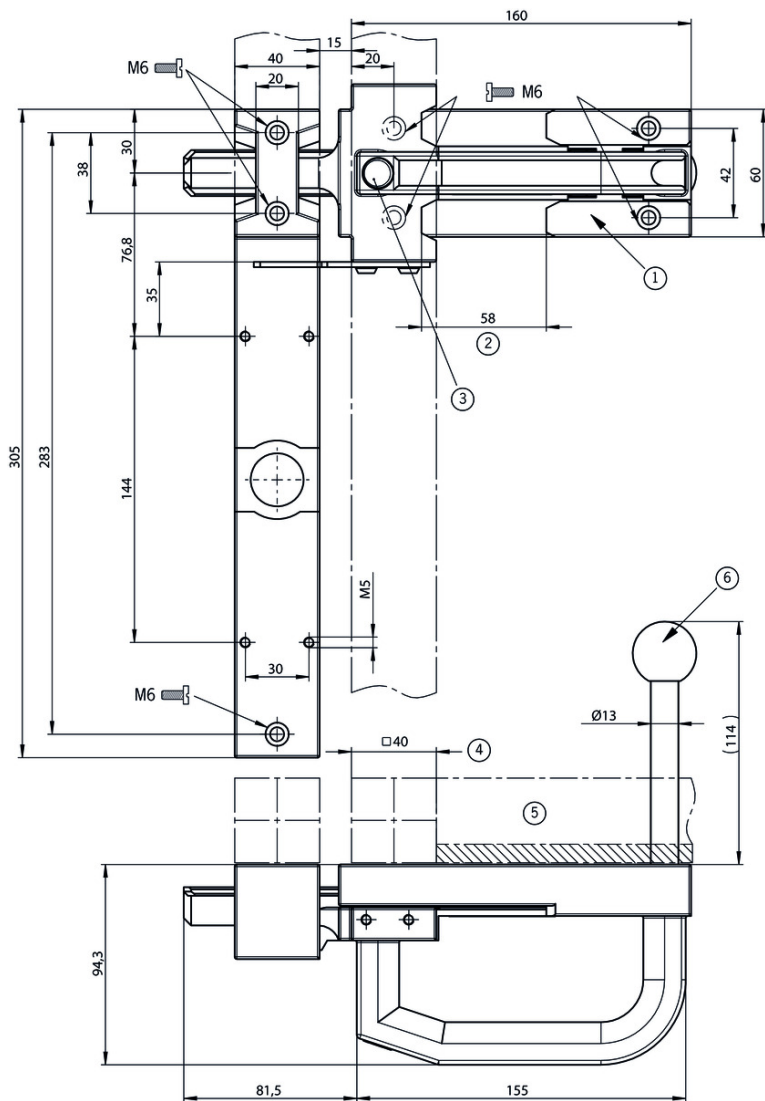

Legende













- 1 Notice: Due to the symmetrical design the bolt can be used for doors hinged on the right and left.
- 2 The bolt latches in open position to prevent unintentional closing of the bolt. Unlocked by pressing the knob.
- 3 Opening
- 4 Safety guard frame (40x40)
- 5 Door hinged on the right
- 6 Escape release

Catalogs

- ▼
 Bezpečnostní spínače s plastovým pouzdrém Sicherheitsschalter mit Kunststoffgehäuse Safety Switches with Plastic Housing Interruptores de seguridad con carcasa plástica Interrupteurs de sécurité avec boîtier plastique 塑料壳体的安全开关

Sicherheitsschalter mit Kunststoffgehäuse	096955	11-03/18		 6.6 MB
Interrupteurs de sécurité avec boîtier plastique	100677	11-03/18		 6.6 MB
Interruptores de seguridad con carcasa plástica	104855	11-03/18		 6.6 MB
Bezpečnostní spínače s plastovým pouzdem	121649	11-03/18		 6.6 MB
Safety Switches with Plastic Housing	096956	11-03/18		 6.6 MB
塑料壳体 的安全开关	116243	11-03/18		 6.2 MB

Sicherheitsschalter mit Metallgehäuse Safety Switches with Metal Housing Bezpečnostní spínače s kovovým pouzdem Interrupteurs de sécurité avec boîtier métallique 金属壳体 的安全开关 Interruptores de seguridad con carcasa metálica

	Doc. no.	Version	Language	Download
Sicherheitsschalter mit Metallgehäuse	100319	11-03/18		 7.9 MB
Interrupteurs de sécurité avec boîtier métallique	100676	11-03/18		 7.9 MB
Interruptores de seguridad con carcasa metálica	104856	11-03/18		 14.0 MB
Safety Switches with Metal Housing	100369	11-03/18		 7.9 MB
Bezpečnostní spínače s kovovým pouzdem	121650	11-03/18		 7.9 MB
金属壳体 的安全开关	102453	11-03/18		 8.2 MB

CAD data

CAD data for this item on TraceParts