

ITEM 029220 NGLE060RT

Description	Technical data	Accessories	Downloads
-------------	----------------	-------------	-----------

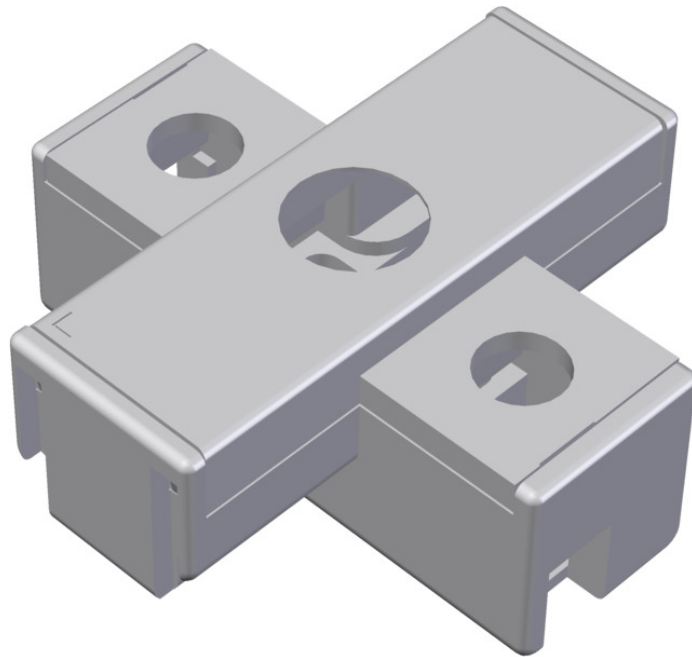

Upgrade kits with LEDs are available for the safety switches NZ. The intensity of the light from the indicators is always the same, independent of the voltage applied.

Note:The LED function display can only be used in conjunction with double switching elements.

Approvals



Electrical connection ratings

Operating voltage	LED	12 ... 60 V [1]
LED indicator		1 LED, red





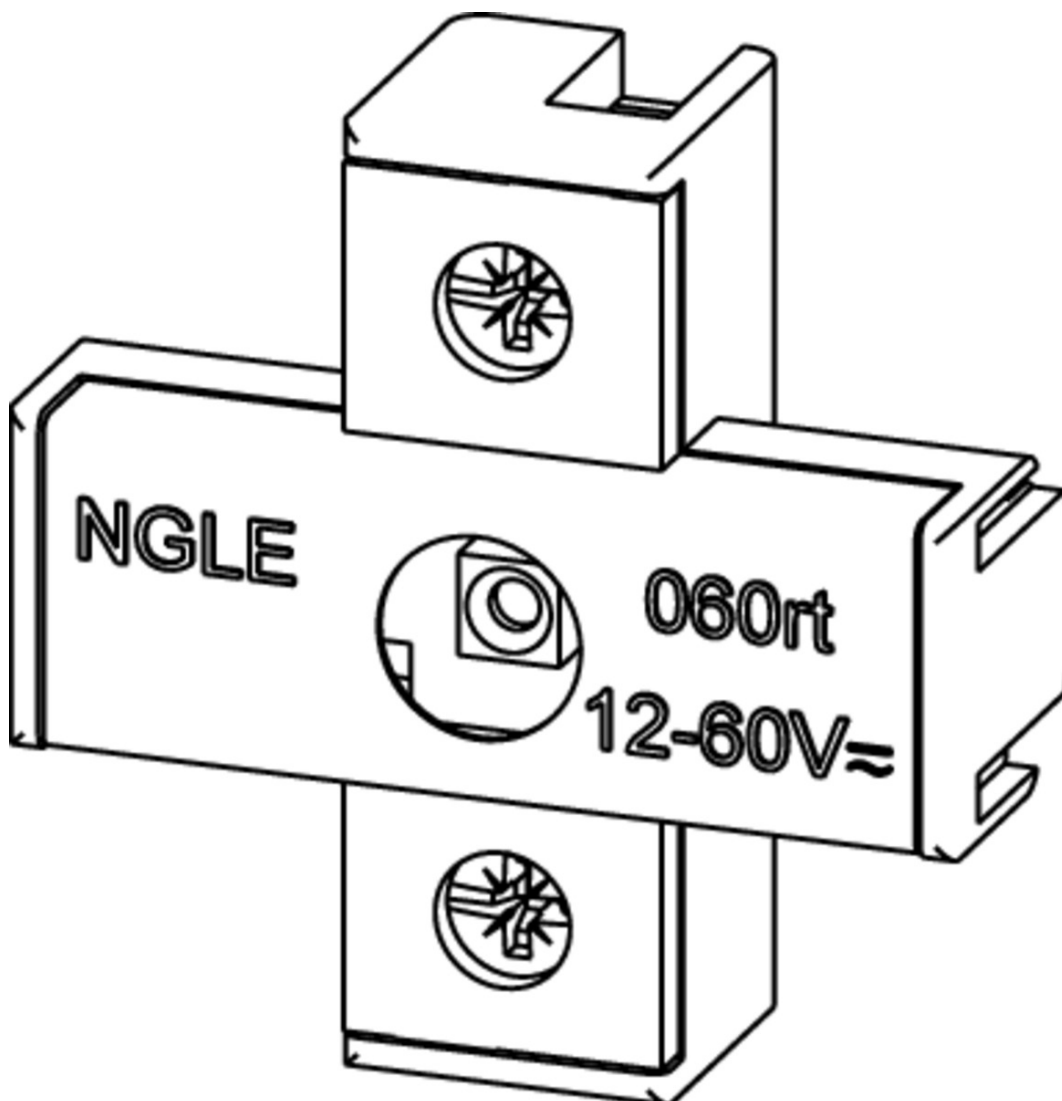







[1] LED with rectifier

Dimension drawing



Catalogs

- ✓ Sicherheitsschalter mit Metallgehäuse Safety Switches with Metal Housing Bezpečnostní spínače s kovovým pouzdem Interrupteurs de sécurité avec boîtier métallique 金属壳体的安全开关 Interruptores de seguridad con carcasa metálica

	Doc. no.	Version	Language	Download
Sicherheitsschalter mit Metallgehäuse	100319	11-03/18		 7.9 MB
Interrupteurs de sécurité avec boîtier métallique	100676	11-03/18		 7.9 MB
Interruptores de seguridad con carcasa metálica	104856	11-03/18		 14.0 MB
Safety Switches with Metal Housing	100369	11-03/18		 7.9 MB
Bezpečnostní spínače s kovovým pouzdem	121650	11-03/18		 7.9 MB
金属壳体的安全开关	102453	11-03/18		 8.2 MB