

ITEM 074415 RADIUSBETAETIGER-Z-O/V25

Description	Technical data	Accessories	Downloads
-------------	----------------	-------------	-----------

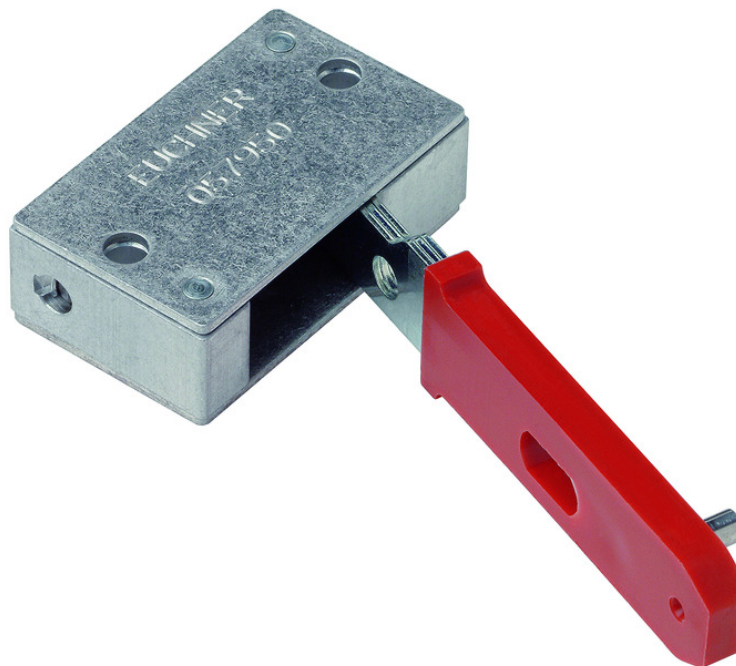

Features

- › Two stainless safety screws per actuator
- › Packaging unit 25 pieces

Hinged actuator

For door radii less than 1000 mm a hinged actuator should be used. The spring action movement of the actuator prevents damage due to the actuator jamming in the actuator head. Depending on the movement of the safety guard, the actuator must be selected for left/right or top/bottom.

Screws made of stainless steel

The safety screws included can be inserted with a normal tool, but cannot be removed again.

Mechanical values and environment

Material

	Actuator	Galvanized steel
	screw	Stainless steel
	Sheath	Plastic
Door radius		min.165 mm
Overtravel		max.4 mm

Miscellaneous





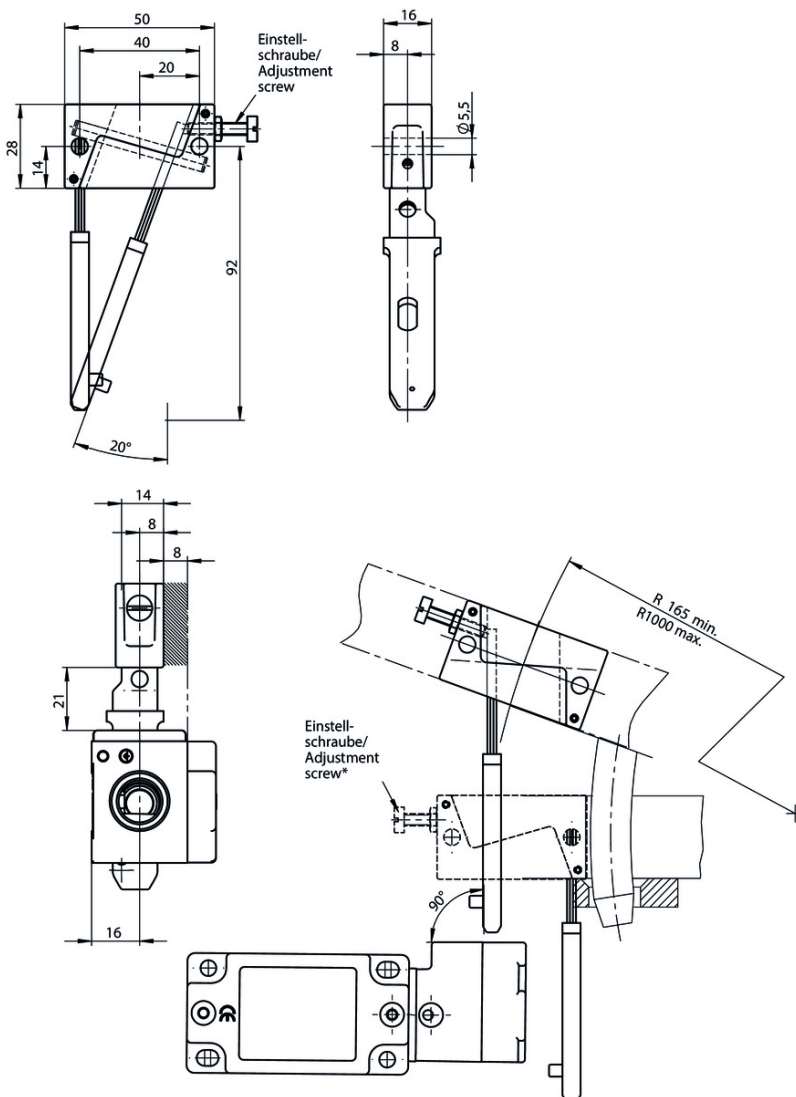







Usability of insertion funnel	No
Packaging unit	25 pcs.

Dimension drawing



Catalogs

- ✓ Sicherheitsschalter mit Metallgehäuse Safety Switches with Metal Housing Bezpečnostní spínače s kovovým pouzdem Interrupteurs de sécurité avec boîtier métallique 金属壳体 的安全开关 Interruptores de seguridad con carcasa metálica

	Doc. no.	Version	Language	Download
Sicherheitsschalter mit Metallgehäuse	100319	11-03/18		 7.9 MB
Interrupteurs de sécurité avec boîtier métallique	100676	11-03/18		 7.9 MB
Interruptores de seguridad con carcasa metálica	104856	11-03/18		 14.0 MB
Safety Switches with Metal Housing	100369	11-03/18		 7.9 MB
Bezpečnostní spínače s kovovým pouzdem	121650	11-03/18		 7.9 MB
金属壳体 的安全开关	102453	11-03/18		 8.2 MB

CAD data

CAD data for this item on TraceParts