

ITEM 074577 BETAETIGER-P-WNT

Description	Technical data	Accessories	Downloads
-------------	----------------	-------------	-----------

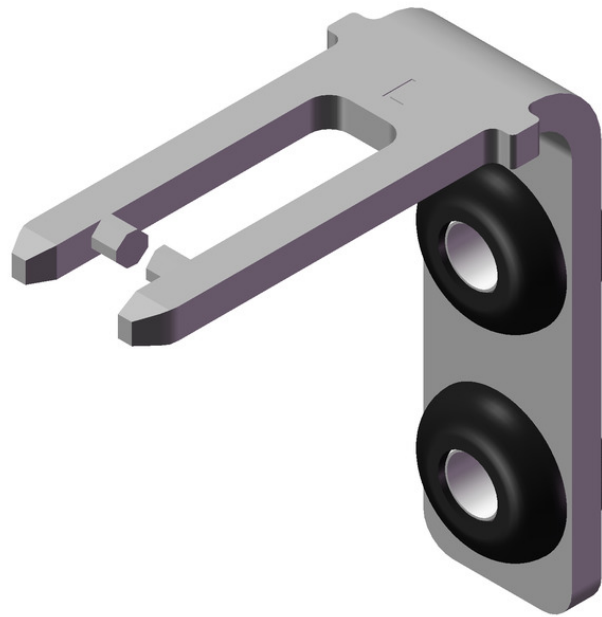

Features

- › Actuators made of stainless steel
- › Two stainless safety screws per actuator
- › Actuators with rubber bushings

Actuators with rubber bushings

For flexible mounting of the actuator.

Screws made of stainless steel

The safety screws included can be inserted with a normal tool, but cannot be removed again.

Mechanical values and environment

Material		
	Actuator	Stainless steel
	screw	Stainless steel

rubber bush	NBR
Door radius	min.1000 mm
Overtravel	max.7 mm

Miscellaneous

Usability of insertion funnel	Yes
-------------------------------	-----



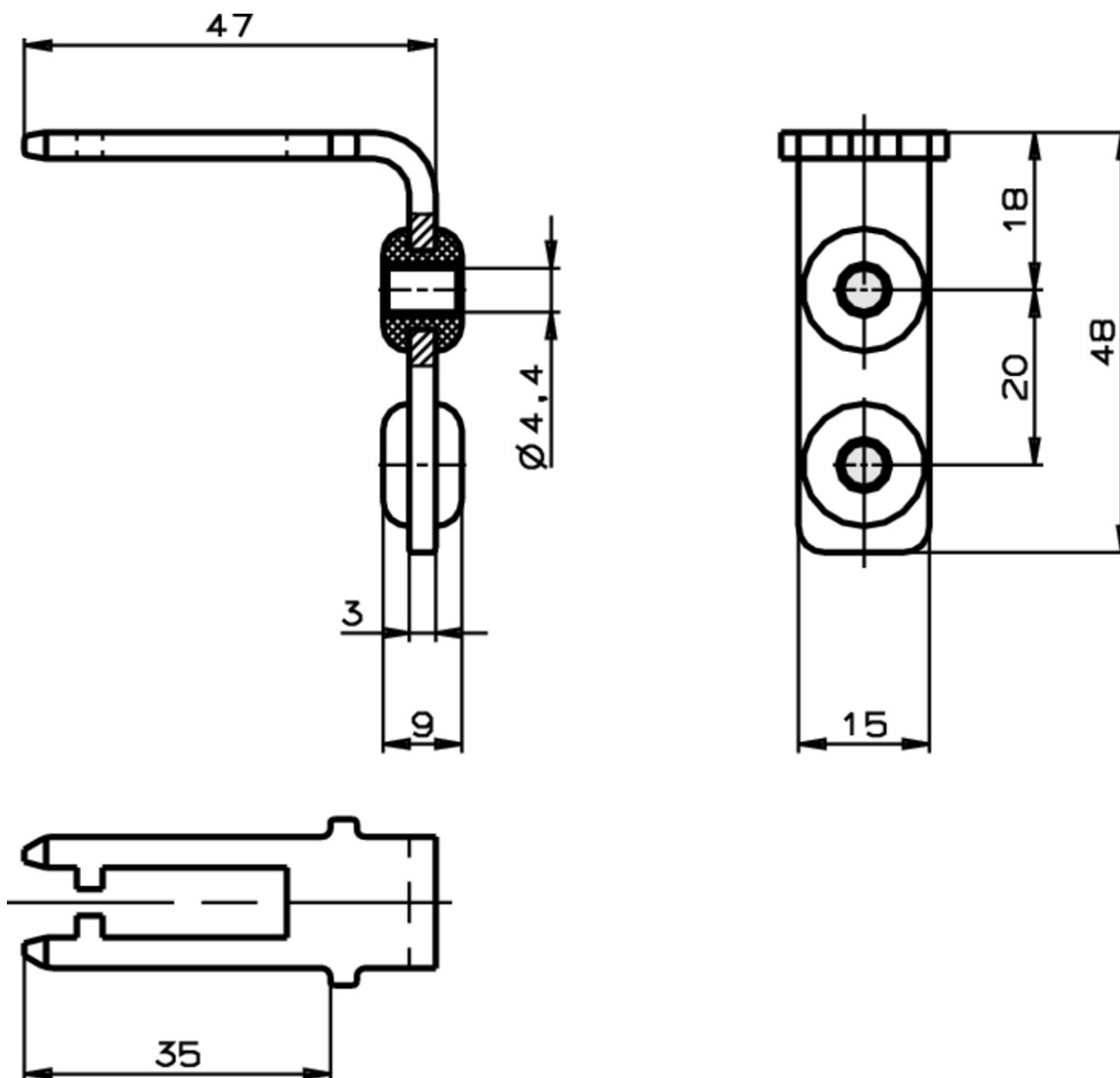









Dimension drawing



Catalogs

- Bezpečnostní spínače s plastovým pouzdrém Sicherheitsschalter mit Kunststoffgehäuse Safety Switches with Plastic Housing Interruptores de seguridad con carcasa plástica Interrupteurs de

sécurité avec boîtier plastique 塑料壳体 的安全开关

	Doc. no.	Version	Language	Download
Sicherheitsschalter mit Kunststoffgehäuse	096955	11-03/18		 6.6 MB
Interrupteurs de sécurité avec boîtier plastique	100677	11-03/18		 6.6 MB
Interruptores de seguridad con carcasa plástica	104855	11-03/18		 6.6 MB
Bezpečnostní spínače s plastovým pouzdem	121649	11-03/18		 6.6 MB
Safety Switches with Plastic Housing	096956	11-03/18		 6.6 MB
塑料壳体 的安全开关	116243	11-03/18		 6.2 MB

CAD data

CAD data for this item on TraceParts