

ITEM 079742 BETAETIGER-X-WNQ

Description	Technical data	Accessories	Downloads
-------------	----------------	-------------	-----------



Features

- › Actuators made of stainless steel
- › Two stainless safety screws per actuator
- › With rubber bush

Actuators with rubber bushings

For flexible mounting of the actuator.

Screws made of stainless steel

The safety screws included can be inserted with a normal tool, but cannot be removed again.

Mechanical values and environment

Material	Actuator	Stainless steel
	screw	Stainless steel

rubber bush	NBR
Door radius	min.440 mm
Overtravel	max.7 mm

Miscellaneous

Usability of insertion funnel	No
-------------------------------	----



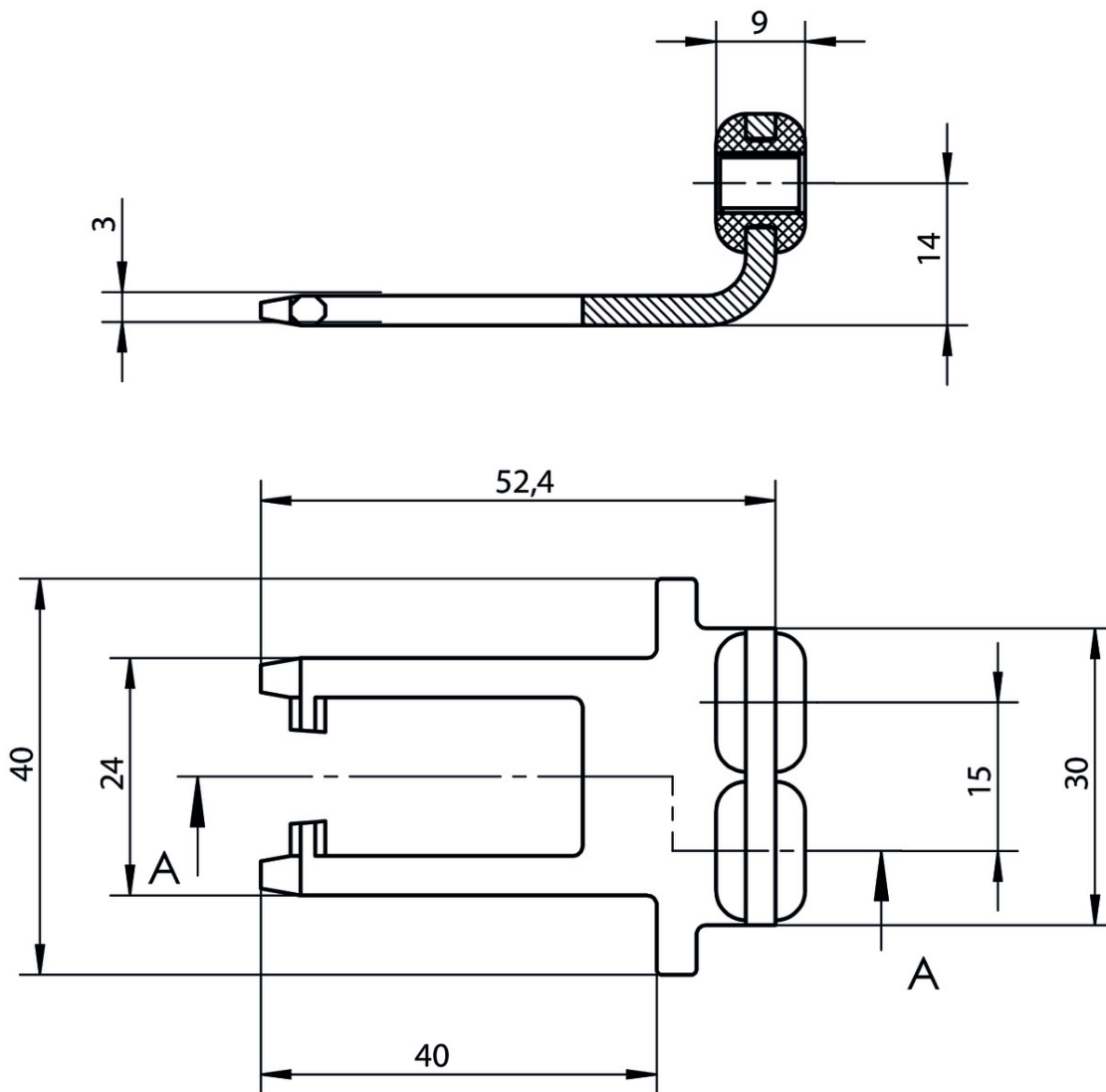









Dimension drawing



Catalogs

- Sicherheitsschalter mit Metallgehäuse Safety Switches with Metal Housing Bezpečnostní spínače s kovovým pouzdem Interrupteurs de sécurité avec boîtier métallique 金属壳体的安全开关

Interruptores de seguridad con carcasa metálica

	Doc. no.	Version	Language	Download
Sicherheitsschalter mit Metallgehäuse	100319	11-03/18		 7.9 MB
Interrupteurs de sécurité avec boîtier métallique	100676	11-03/18		 7.9 MB
Interruptores de seguridad con carcasa metálica	104856	11-03/18		 14.0 MB
Safety Switches with Metal Housing	100369	11-03/18		 7.9 MB
Bezpečnostní spínače s kovovým pouzdem	121650	11-03/18		 7.9 MB
金属壳体 的安全开关	102453	11-03/18		 8.2 MB

CAD data

CAD data for this item on TraceParts