

ITEM 098082 RADIUSBETAETIGER-X-LR-N

Description	Technical data	Accessories	Downloads
-------------	----------------	-------------	-----------

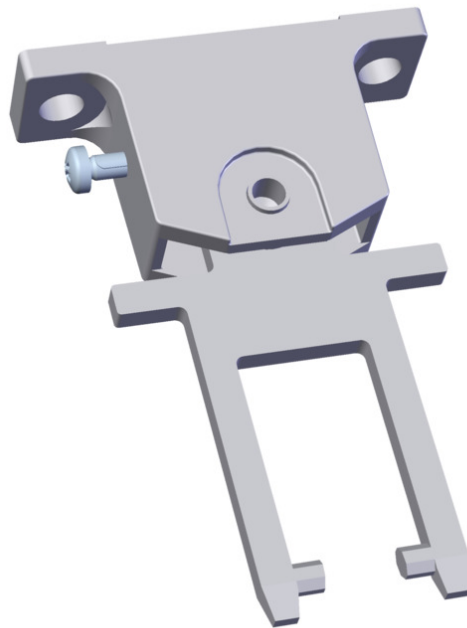

Features

- › Actuators made of stainless steel
- › Two stainless safety screws per actuator

Hinged actuators

For door radii less than 300 mm a hinged actuator should be used. The spring action movement of the actuator prevents damage due to the actuator jamming in the actuator head. Depending on the movement of the safety guard, the actuator must be selected for left/right or top/bottom.

Screws made of stainless steel

The safety screws included can be inserted with a normal tool, but cannot be removed again.

Mechanical values and environment

Material	
----------	--

Actuator screw	Stainless steel
Door radius	min.100 mm
Overtravel	max.7 mm

Miscellaneous

Usability of insertion funnel	No
-------------------------------	----



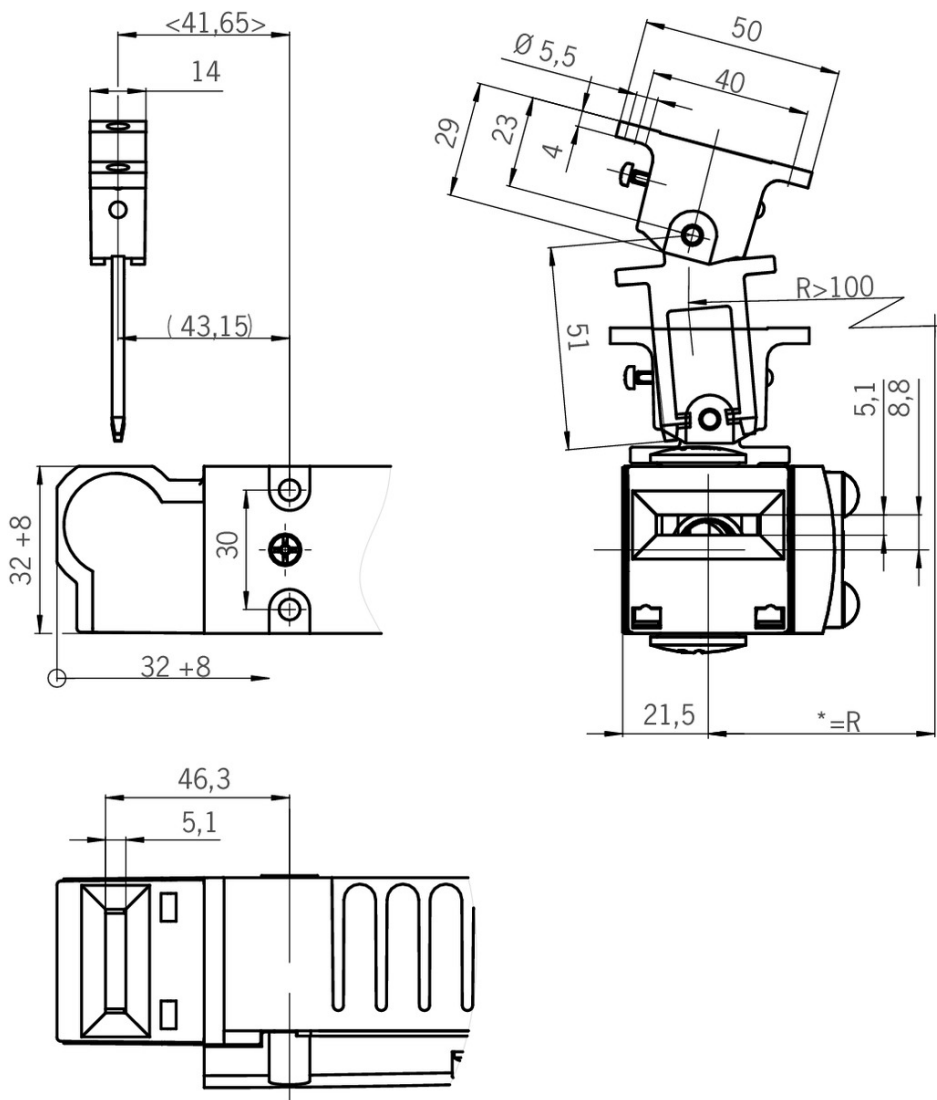









Dimension drawing



Catalogs

- ▼ Sicherheitsschalter mit Metallgehäuse Safety Switches with Metal Housing Bezpečnostní spínače s kovovým pouzdem Interrupteurs de sécurité avec boîtier métallique 金属壳体的安全开关

Interruptores de seguridad con carcasa metálica

	Doc. no.	Version	Language	Download
Sicherheitsschalter mit Metallgehäuse	100319	11-03/18		 7.9 MB
Interrupteurs de sécurité avec boîtier métallique	100676	11-03/18		 7.9 MB
Interruptores de seguridad con carcasa metálica	104856	11-03/18		 14.0 MB
Safety Switches with Metal Housing	100369	11-03/18		 7.9 MB
Bezpečnostní spínače s kovovým pouzdem	121650	11-03/18		 7.9 MB
金属壳体 的安全开关	102453	11-03/18		 8.2 MB

CAD data

CAD data for this item on TraceParts