

**ITEM 098313 AE-B-A1-03,0-098313**

Description	Technical data	Accessories	Downloads
-------------	----------------	-------------	-----------



**Features**

- › Can be used as escape release or emergency unlocking
- › No automatic return
- › Sheath length 3 m (rope length 6 m)

Flexible routing of the pull wire permits release of the guard locking in inaccessible installation situations.

- › Usage as emergency unlocking if the safety switch is mounted in an inaccessible position
- › Usage as escape release for unlocking the guard locking from the danger area
- › Can be retrofitted to all series CTP/TP/STP/STA safety switches

**Mechanical values and environment**

Sheath length	Outer	3 m
Housing material		Plastic
Rope length	Cabling rope	6 m

## Miscellaneous

Detent mechanism

Yes **[1]**

**[1]** Not resetting

## Dimension drawing

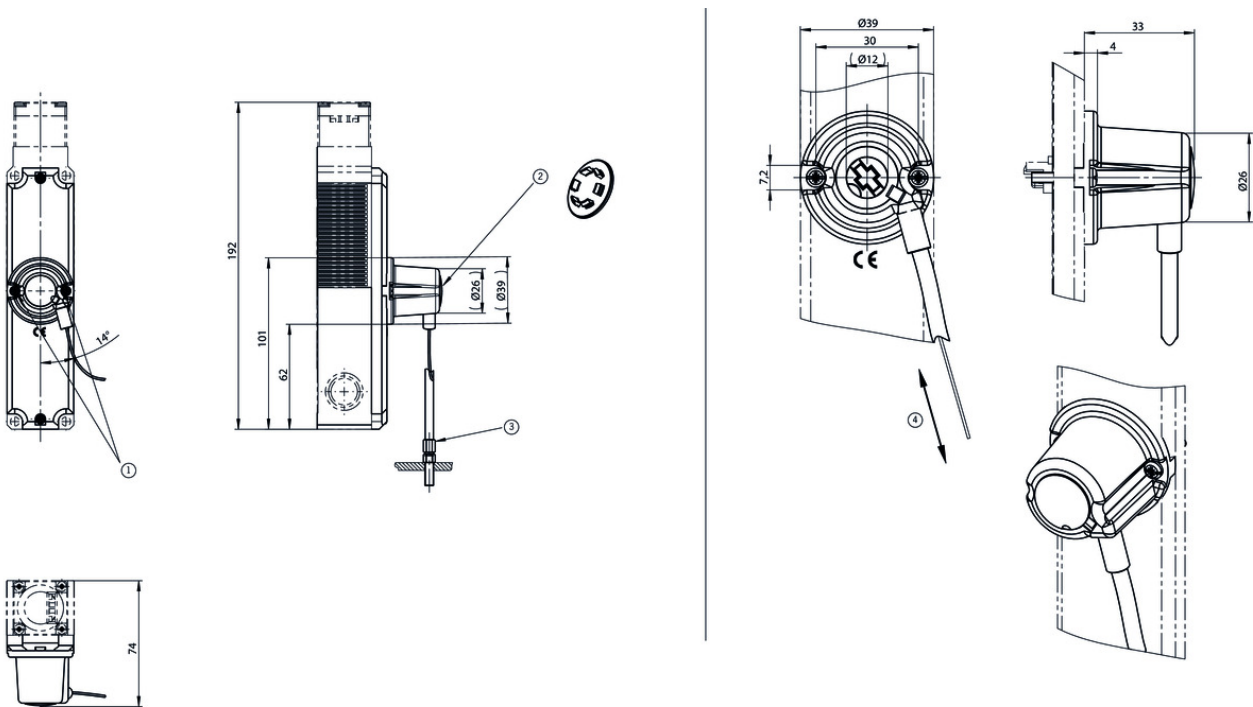

## Legende

- 1 Mounting by means of the screw included, length: 17mm!
- 2 Cover
- 3 Adjusting screw M5x17.5 for fixing the hose cable (included).
- 4 A stroke of min. 17mm is necessary for reliable release.

## Function expansion

Handle for wire front release



**099795** AY-HDL-099795

Features

- › Suitable for all wire front releases





**124204** AY-HDL-124204

▼ Features

› Suitable for all wire front releases













## Instructions

▼ Montageanleitung Bowdenzugentriegelung













	Doc. no.	Version	Language	Download
Montageanleitung Bowdenzugentriegelung Assembly Instructions Wire Front Release (Bowden)	125443	01-07/15	 	 0.6 MB

## Catalogs

▼ Bezpečnostní spínače s plastovým pouzdrém Sicherheitsschalter mit Kunststoffgehäuse Safety Switches with Plastic Housing Interruptores de seguridad con carcasa plástica Interrupteurs de sécurité avec boîtier plastique 塑料壳体 的安全开关

	Doc. no.	Version	Language	Download
Sicherheitsschalter mit Kunststoffgehäuse	096955	11-03/18		 6.6 MB
Interrupteurs de sécurité avec boîtier plastique	100677	11-03/18		 6.6 MB
Interruptores de seguridad con carcasa plástica	104855	11-03/18		 6.6 MB
Bezpečnostní spínače s plastovým pouzdrém	121649	11-03/18		 6.6 MB
Safety Switches with Plastic Housing	096956	11-03/18		 6.6 MB
塑料壳体 的安全开关	116243	11-03/18		 6.2 MB

▼ Sicherheitsschalter mit Metallgehäuse Safety Switches with Metal Housing Bezpečnostní spínače s kovovým pouzdrém Interrupteurs de sécurité avec boîtier métallique 金属壳体 的安全开关 Interruptores de seguridad con carcasa metálica

	Doc. no.	Version	Language	Download
Sicherheitsschalter mit Metallgehäuse	100319	11-03/18		 7.9 MB
Interrupteurs de sécurité avec boîtier métallique	100676	11-03/18		 7.9 MB
Interruptores de seguridad con carcasa metálica	104856	11-03/18		 14.0 MB
Safety Switches with Metal Housing	100369	11-03/18		 7.9 MB
Bezpečnostní spínače s kovovým pouzdrém	121650	11-03/18		 7.9 MB
金属壳体 的安全开关	102453	11-03/18		 8.2 MB