

## ITEM 105071 C-M12F08-07X025PV20,0-MA-105071

Description	Technical data	Accessories	Downloads
-------------	----------------	-------------	-----------



### Features

- › M12 female plug, 8-pin
- › Angled plug connector
- › PVC cable
- › Cable length 20 m
- › With flying lead

These special connection cables are needed for the connection of the CET to a CES evaluation unit. Please take into account in the order!  
Interference is prevented by special screening.

### Important

Connection cables are not allowed to be extended.

### Notice

The connection cables with PUR sheath are suitable for drag chains with a minimum bending radius of 60 mm (10 times the cable diameter).

## Mechanical values and environment

Sheath material	PVC
Conductor material	Cu
Drag chain suitability	No
Silicone-free	Yes
Ambient temperature	
	Static -40°C / +80°C
	Dynamic +5°C / + 80°C
Number of conductors	7
Type of cable	straight
Cable length	20 m
Cable outlet	Angle
Cable diameter	
	Approx. 5,8 mm
Conductor cross-section	0.25 mm <sup>2</sup>
Conductor identification	Color code
Sheath color	Black
Bending radius	10 x cable diameter
	<b>Connection 1</b>
Degree of protection	IP67
Plug lock material	CuZn, nickel-plated
Connection	M12
Connection type	Socket
Number of pins	8
Plug lock	Screw connection
Plug housing material	TPU, self-extinguishing
	<b>Connection 2</b>
Conductor end	Sheath stripped
Connection	Flying lead

## Electrical connection ratings

Rated voltage	30 V
Nominal current	
	At 40° C 2 A
Rated voltage	36 V
Degree of contamination according to EN 60664-1	3
Test voltage	1,5 kV
Individual shielding	Yes, screen around flexible wires BN and WH connected to pin 3, coverage approx. 85%

## Dimension drawing

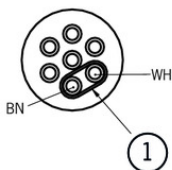
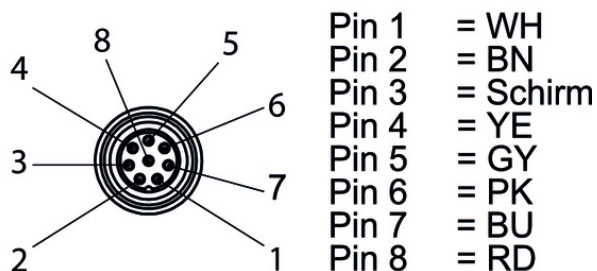
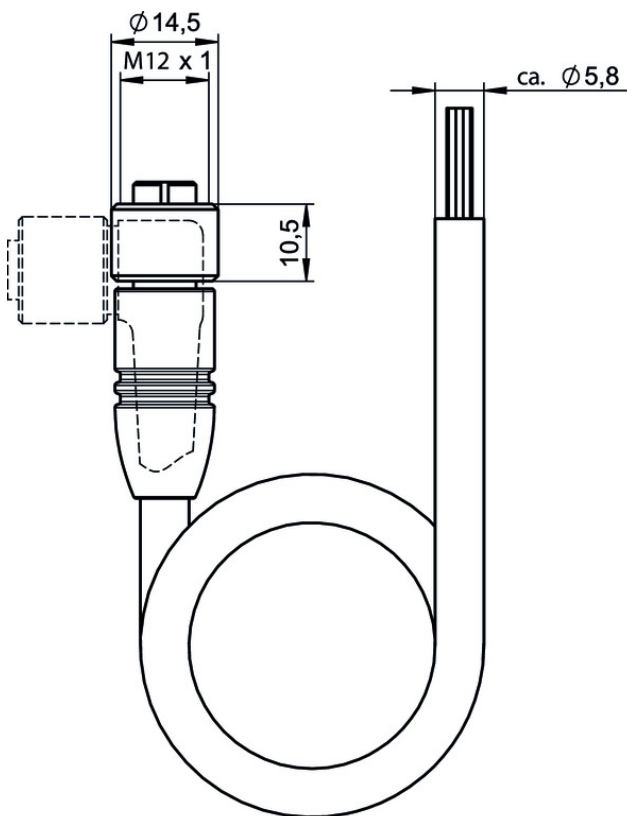

## Legende

1 Screen (pin 3 screen around WH and BN)

## Catalogs

▼ Transpondercodierte Sicherheitssysteme mit externer Auswertung Transponder-coded safety systems with external evaluation Sistemas de seguridad con codificación por transponder y evaluación externa Systèmes de sécurité à codage par transpondeur avec analyse externe

	Doc. no.	Version	Language	Download
Transpondercodierte Sicherheitssysteme mit externer Auswertung	127596	02-01/18		3.1 MB
Systèmes de sécurité à codage par transpondeur avec analyse externe	137968	02-01/18		3.0 MB
Sistemas de seguridad con codificación por transponder y evaluación externa	139969	02-01/18		3.0 MB

Transponder-coded safety systems with external evaluation

127597

02-01/18



3.0 MB

**CAD data**

CAD data for this item on TraceParts