

ITEM 103557 C-R08F06-06X014PV10,0-ES-103557

Description	Technical data	Accessories	Downloads
-------------	----------------	-------------	-----------



Features

- › Connection cable for CES-AP-C.2-...
- › Female plug, 6-pin
- › snap-on
- › PVC cable, straight
- › Cable length 10 m
- › With flying lead

Mechanical values and environment

Sheath material	PVC
Conductor insulation material	PVC
Fire behavior	According to VDE0472
	According to VDE 0472
Drag chain suitability	No
UV resistance	Largely according to VDE0472
Ambient temperature	

	static	-30 ... +70 °C
	Dynamic	0 ... +70 °C
Number of conductors		6
Type of cable		straight
Cable length		10 m
Cable diameter	Approx.	4,5 mm
Conductor cross-section		0.14 mm ²
Conductor identification		Color code
Sheath color		gray
Bending radius	static	5 x cable diameter
	Dynamic	10 x cable diameter
		Connection 1
Degree of protection		IP67 [1]
Insertion cycles		100
Connection		Plug connector Ø8
Connection type		Socket
Cable outlet		straight
Number of pins		6
Plug lock		Snap-on
Plug housing material		TPU
		Connection 2
Conductor end		Cable end sleeves
Connection		Flying lead

Electrical connection ratings

Rated voltage	30 V
Specific cable resistance	150 Ω/km
Specific inductance	0,65 mH/km
Specific capacitance	120 nF/km
	Connection 1
Degree of contamination according to EN 60664-1	3

[1] In the inserted state

Dimension drawing

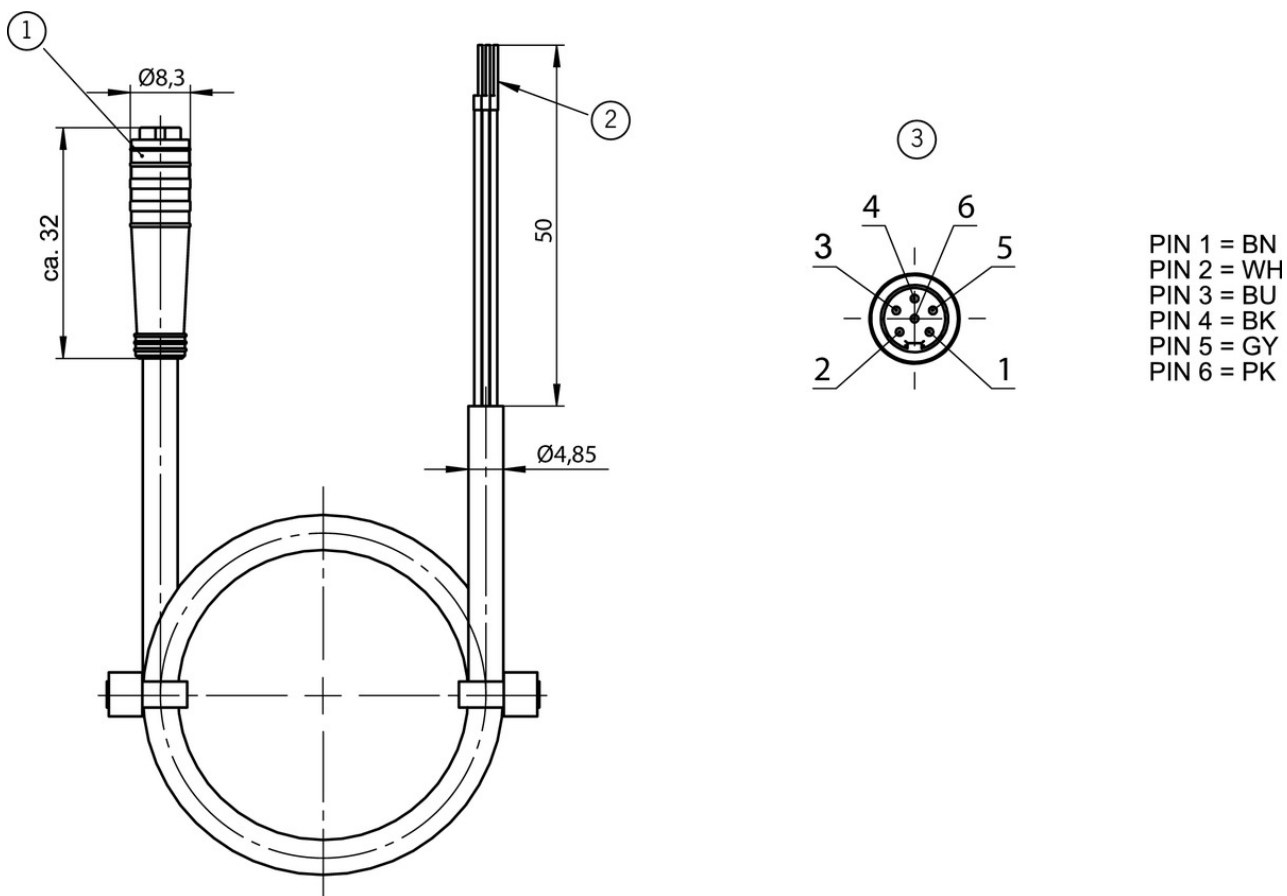



Legende

- 1 Female plug 8 mm, 6-pin
- 2 Crimped ferrules
- 3 Terminal assignment as seen from the connection side

Catalogs

- ▼ Transpondercodierte Sicherheitsschalter - Verriegelungseinrichtungen und Zuhaltungen
 Transponder-coded safety switches - Interlocking devices and guard locking devices
 Interruptores de seguridad con codificación por transponder - Dispositivos de enclavamiento y bloqueos
 Interrupteurs de sécurité à codage par transpondeur - Dispositifs de verrouillage et interverrouillages

	Doc. no.	Version	Language	Download
Transpondercodierte Sicherheitsschalter - Verriegelungseinrichtungen und Zuhaltungen	127594	02-01/18		5.2 MB
Interrupteurs de sécurité à codage par transpondeur - Dispositifs de verrouillage et interverrouillages	137558	02-01/18		5.2 MB

Interruptores de seguridad con codificación por transponder - Dispositivos de enclavamiento y bloqueos	137560	02-01/18		 5.2 MB
Transponder-coded safety switches - Interlocking devices and guard locking devices	127595	02-01/18		 5.1 MB