

ITEM 105559 C-M05F04-02X014PV20,0-ES-105559

Description	Technical data	Accessories	Downloads
-------------	----------------	-------------	-----------

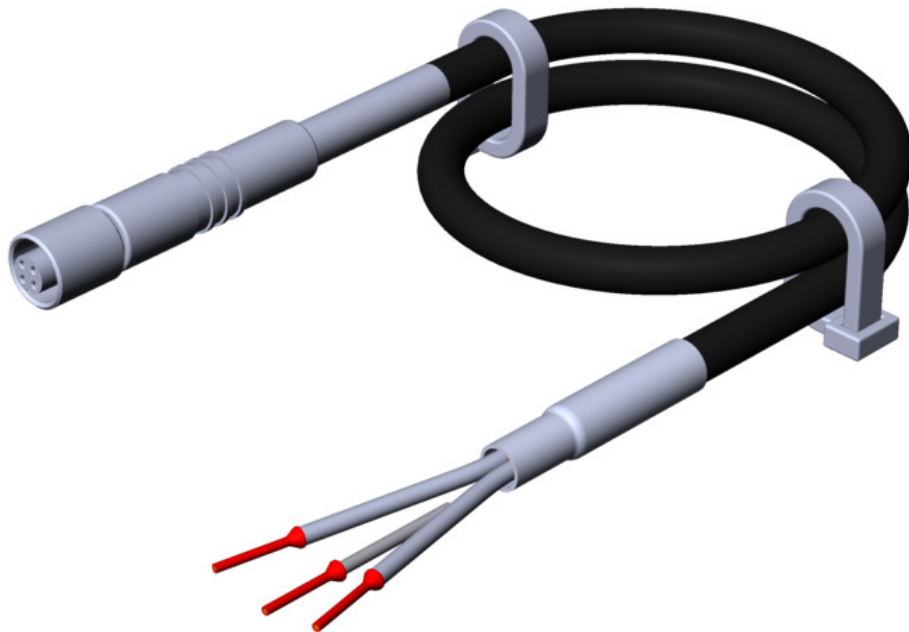

Features

- › M5 female plug, 4-pin
- › Straight plug connector
- › PVC cable
- › Cable length 20 m
- › With flying lead

Mechanical values and environment

Sheath material	PVC
Fire behavior	Self-extinguishing and flame retardant ^[1]
Resistance to media	Largely resistant to certain oils, acids and alkali
Drag chain suitability	No
Ambient temperature	
	static -25 ... +80 °C
	Dynamic -5 ... +70 °C
Number of conductors	2
Type of cable	straight

Cable length	20 m
Cable diameter	
Approx.	3,7 mm
Conductor cross-section	0.14 mm ²
Conductor identification	Color code
Sheath color	gray
Bending radius	
static	5 x cable diameter
Dynamic	10 x cable diameter
	Connection 1
Degree of protection	IP67 [2]
Insulating material group	I
Connection	Plug connectors M5x0.5
Connection type	Socket
Cable outlet	straight
Number of pins	4
Plug lock	Screw connection
Plug housing material	PUR
	Connection 2
Conductor end	Cable end sleeves
Connection	Flying lead

Electrical connection ratings

Overvoltage category according to IEC EN 60664-1	II
Rated surge voltage according to IEC 60664-1	800 V
Cable shielding	Yes [3]
	Connection 1
Degree of contamination according to EN 60664-1	3

[1] to IEC 60332-1

[2] In the inserted state

[3] Cu braid, tinned, approx. 85%

Dimension drawing

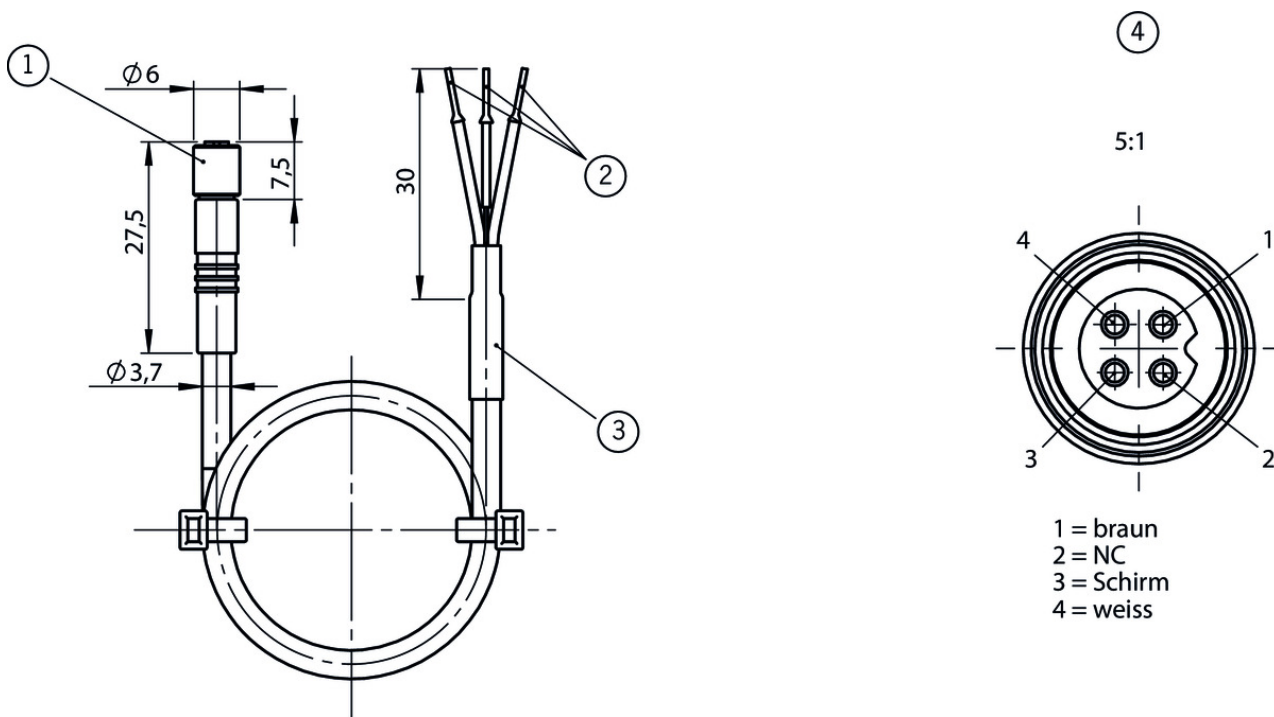

Legende

- 1 Female plug M5, 4-pin
- 2 Crimped ferrules
- 3 Shrinkable tubing
- 4 Terminal assignment as seen from the connection side

Catalogs

- Transpondercodierte Sicherheitssysteme mit externer Auswertung Transponder-coded safety systems with external evaluation Sistemas de seguridad con codificación por transponder y evaluación externa Systèmes de sécurité à codage par transpondeur avec analyse externe

	Doc. no.	Version	Language	Download
Transpondercodierte Sicherheitssysteme mit externer Auswertung	127596	02-01/18		3.1 MB
Systèmes de sécurité à codage par transpondeur avec analyse externe	137968	02-01/18		3.0 MB
Sistemas de seguridad con codificación por transponder y evaluación externa	139969	02-01/18		3.0 MB
Transponder-coded safety systems with external evaluation	127597	02-01/18		3.0 MB