

## ITEM 106221 MGB-H-AA1A2-L-106221

Description	Technical data	Accessories	Downloads
-------------	----------------	-------------	-----------



### Features

- › Intelligent bolt tongue
- › Lockout bar
- › Door handle
- › Mounting plate

### Bolt tongue

The bolt tongue is reliably detected by transponder as soon as it is inserted in the evaluation module.

### Lockout bar

The bolt tongue can be blocked for cleaning and service with max. 3 locks.

### Door handle

The MGB has a robust door handle that can be rotated in 90° steps to suit all installations. The actuating direction can be changed for left or right hinged doors.

## Door knob

As an alternative to the door handle the handle module can also be equipped with a door knob.

## Approvals



## Mechanical values and environment

Housing material	Reinforced plastic, die-cast zinc nickel-plated, stainless steel
Weight	Net 1,00 kg
Ambient temperature	-20 ... 55 °C
Degree of protection	IP65
Installation position	Door hinge DIN left

## Miscellaneous

Additional feature	With mounting plate
Product version number	V3.0.0

**Dimension drawing**

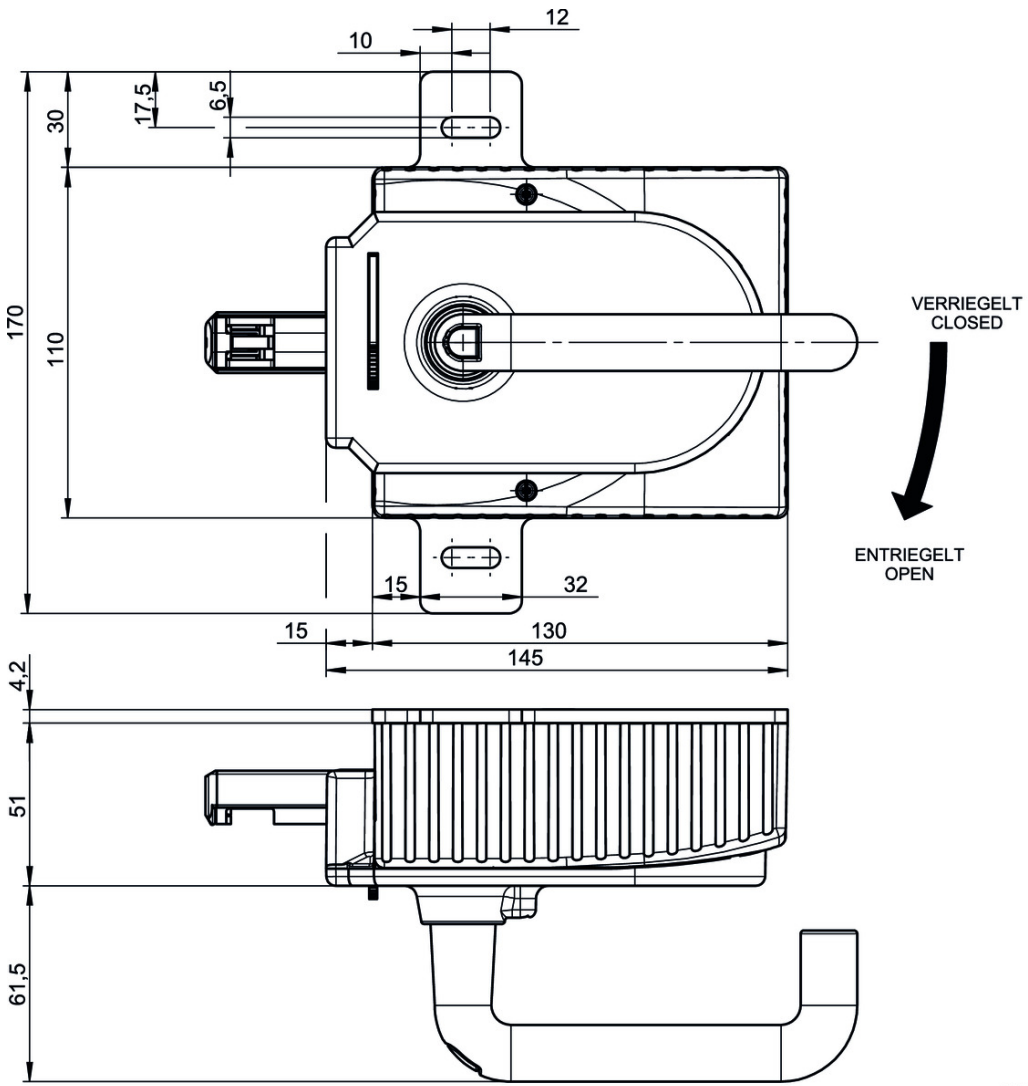

...

## Dimension drawing

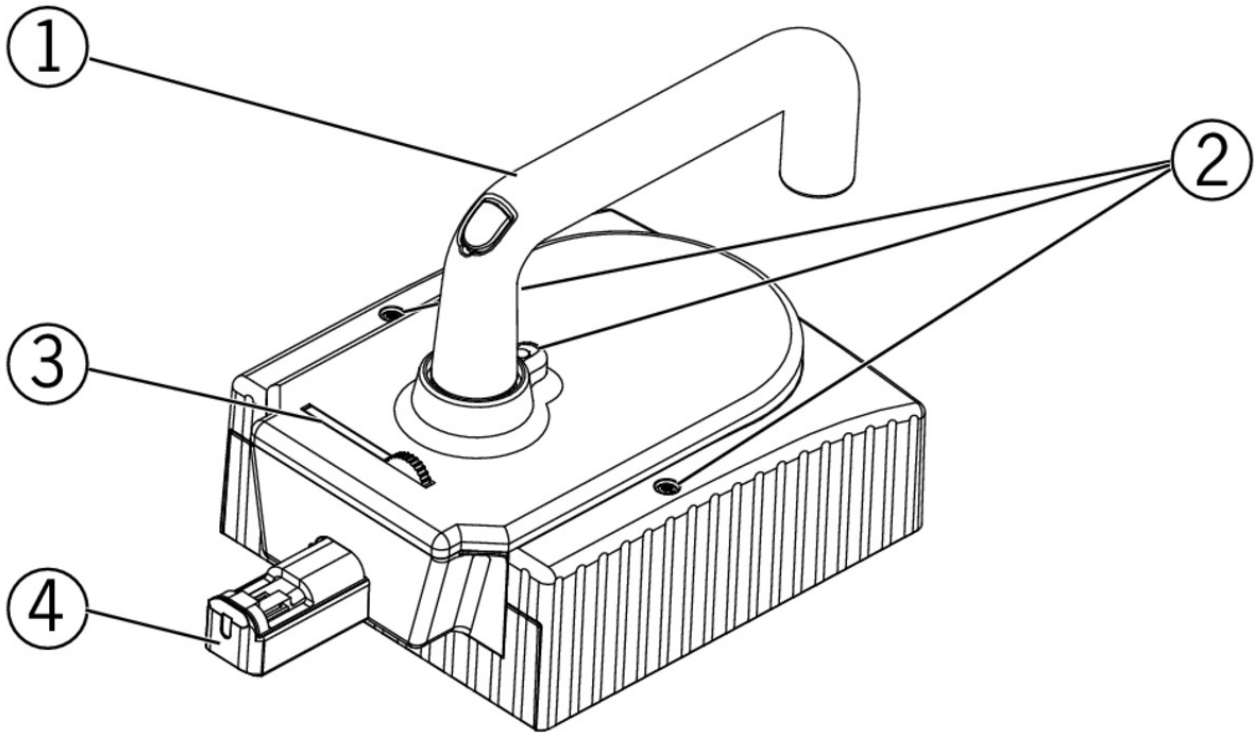

## Function expansion

### ▼ Door handle for MGB-H...



#### **123926** MGB-A-DOORHANDLE-S2-123926

##### ▼ Features

- › Aluminum silver anodized
- › For mounting on all MGB handle modules MGB-H from V3.0.0



#### **110277** MGB-A-DOORHANDLE-S1-110277

##### ▼ Features

- › Aluminum silver anodized
- › For mounting on all MGB handle modules MGB-H up to V2.0.0

### ▼ Door knob for MGB-H...



#### **124030** MGB-A-DOORKNOB-S2-124030

##### ▼ Features

- › Aluminum, silver anodized
- › For mounting on all MGB handle modules MGB-H... from V3.0.0
- › e.g. on sliding doors



























#### **111460** MGB-A-DOORKNOB-S1-111460

##### ▼ Features

- › Aluminum, silver anodized
- › For mounting on all MGB handle modules MGB-H... up to V2.0.0
- › e.g. on sliding doors













## Instructions

▼ Sicherheitsinformation (Teil der Betriebsanleitung Sicherheitssystem MGB-AR/MGB-AP) ab V3.0.0

	Doc. no.	Version	Language	Download
Sicherheitsinformation (Teil der Betriebsanleitung Sicherheitssystem MGB-AR/MGB-AP) ab V3.0.0 Información de seguridad (parte del manual de instrucciones Sistema de seguridad MGB-AR/MGB-AP) V3.0.0 o superior Information de sécurité (partie du mode d'emploi Système de sécurité MGB-AR/MGB-AP) à partir de V3.0.0 Informazioni sulla sicurezza (Parte delle istruzioni di impiego Sistema di sicurezza MGB-AR/MGB-AP) da V3.0.0 Säkerhetsinformation (Del av instruktionsboken Säkerhetssystem MGB-AR/MGB-AP) från V3.0.0 Safety Information (Part of the Operating Instructions Safety System MGB-AR/MGB-AP) from V3.0.0	123151	01-02/15	     	 0.6 MB
Veiligheidsinformatie (Deel van de handleiding Beveiligingssysteem MGB-AR/MGB-AP) vanaf V3.0.0	123151	01-02/15		 0.2 MB
Informação de segurança (Parte do manual de instruções Sistema de segurança MGB-AR/MGB-AP) a partir de V3.0.0	123151	01-02/15		 0.2 MB
Bezpečnostní informace (součást návodu k použití „Bezpečnostní systém MGB-AR/MGB-AP“) od V3.0.0	123151	01-02/15		 0.2 MB
Informacje o bezpieczeństwie (Część instrukcji obsługi System bezpieczeństwa MGB-AR/MGB-AP) od V3.0.0	123151	01-02/15		 0.2 MB
Информация о безопасности (часть инструкции по эксплуатации Предохранительная система MGB-AR/MGB-AP) с V3.0.0	123151	01-02/15		 0.3 MB
Bezpečnostná informácia (časť návodu na prevádzku Bezpečnostný systém MGB-AR/MGB-AP) od V3.0.0	123151	01-02/15		 0.2 MB
Güvenlik bilgisi (İşletim kılavuzunun parçası emniyet sistemi MGB-AR/MGB-AP) V3.0.0 ve üstü	123151	01-02/15		 0.3 MB
安全信息 (安全系统 MGB-AR/MGB-AP使用说明书的组成部分) V3.0.0以上	123151	01-02/15		 0.3 MB
安全情報 MGB-AR/MGB-AP	123151	01-02/15		 0.6 MB





## Catalogs

▼ Multifunctional Gate Box MGB Multifunctional Gate Box MGB Multifunctional Gate Box MGB  
Multifunctional Gate Box MGB Multifunctional Gate Box MGB 多功能系统安全控制系统 MGB

	<b>Doc. no.</b>	<b>Version</b>	<b>Language</b>	<b>Download</b>
Multifunctional Gate Box MGB	106108	10-02/18		 8.2 MB
Multifunctional Gate Box MGB	109155	10-02/18		 8.2 MB
Multifunctional Gate Box MGB	114433	10-02/18		 8.3 MB
Multifunctional Gate Box MGB	121652	10-02/18		 8.0 MB
Multifunctional Gate Box MGB	106109	10-02/18		 8.2 MB
多功能系统安全控制系统 MGB	155883	10-02/18		 8.3 MB

### Declaration of conformity

▼ EU-Konformitätserklärung

	<b>Doc. no.</b>	<b>Version</b>	<b>Language</b>	<b>Download</b>
EU-Konformitätserklärung	2123150	08-01/17		 0.3 MB
Declaración UE de conformidad				
Déclaration UE de conformité				
Dichiarazione di conformità				
EU declaration of conformity			