

## ITEM 109813 STP-TW-4A-4141AC024SEM4AS1

Description	Technical data	Accessories	Downloads
-------------	----------------	-------------	-----------



### Features

- › Two actuating heads made of metal
- › Auxiliary release on the front
- › With plug connector M12

### Function

In the safe state, both actuators must be inserted into the switch head.

### Guard locking type

**STP-TW3** Closed-circuit current principle, guard locking by spring force. Release by control of AS-i output 0.

### Control of the guard locking solenoid

The guard locking solenoid is controlled by the control system via AS-Interface bus bit D0. In addition the 24V connection can be switched safely.

### AS-Interface inputs

**D0, D1** Door monitoring contact SK  
**D2, D3** Solenoid monitoring contact ÜK  
Evaluation is performed via a safety monitor.

---

### AS-Interface outputs

**D0** Guard locking solenoid  
**D1** Red LED  
**D2** Green LED

---

### LED function display

- › The Power LED indicates the operating voltage on the bus.
  - › The Fault LED indicates if a fault has been detected on the AS-Interface bus.
  - › The green and the red LEDs can be controlled as required by the control system via the bus using bits D1 and D2.
- 

### Auxiliary release

Is used for releasing the guard locking with the aid of a tool. To protect against tampering, the auxiliary release is sealed with sealing lacquer.

### Approvals



### Mechanical values and environment

Housing material	Reinforced thermoplastic
Weight	
	Net 0,5 kg
Ambient temperature	-20 ... 55 °C
Degree of protection	IP67
Mechanical life	1 x 10 <sup>6</sup>
Contact material	Silver alloy, gold flashed
Switching principle	Slow-action switching contact
Installation position	Any
Number of door position positively driven contacts	
According to As-i Safety at Work	1 D0,D1 [1]
Number of guard lock monitoring positively driven contacts	
According to As-i Safety at Work	1 D2,D3 [2]
Connection	
	1 x Plug connector M12 [3]
Approach speed	

	max.	20 m/min
Actuation frequency		1200 1/h
Guard locking principle		Open-circuit current principle
Locking force $F_{max}$		2500 N
Locking force $F_{Zh}$		2000 N
Retention force		20 N
Extraction force		30 N
Actuating force		35 N

### Electrical connection ratings

ASi voltage		22,5 ... 30 V 31,6 V
ASi operating current		max.45 mA
ASi auxiliary voltage		
	IEC 60742, PELV	24 V -15% ... +10%
ASi auxiliary current		300 mA
Solenoid duty cycle		100 %
ASi slave type		
	According to ASI specification 2.1	EA code: 7
	According to ASI specification 2.1	ID code: B
ASi data in		
	According to ASI safety at work	D0,D1,D2,D3 [4]
ASi data out		
	Guard locking solenoid	D0 [5]
	LED red	D1 [6]
	LED green	D2 [7]
ASi LED		
	LED green	Power [8]
	LED red	Fault [9]

### Reliability values acc. to EN ISO 13849-1

$B_{10D}$		$5 \times 10^6$
-----------	--	-----------------

### in combination with Actuator BETAETIGER-S-GT-SN

### Mechanical values and environment

Overtravel		
	Horizontal	5 mm
	Vertical	5 mm
Insertion depth		
	Horizontal	24,5 mm
	Vertical	24,5 mm

- [1] 1 = Door closed
- [2] 1 = Locked
- [3] 4-pin
- [4] See positively driven NC contact
- [5] 1 = Solenoid energized
- [6, 7] 1 = LED on
- [8] ASI voltage is present
- [9] Offline phase or address 0

**Dimension drawing**

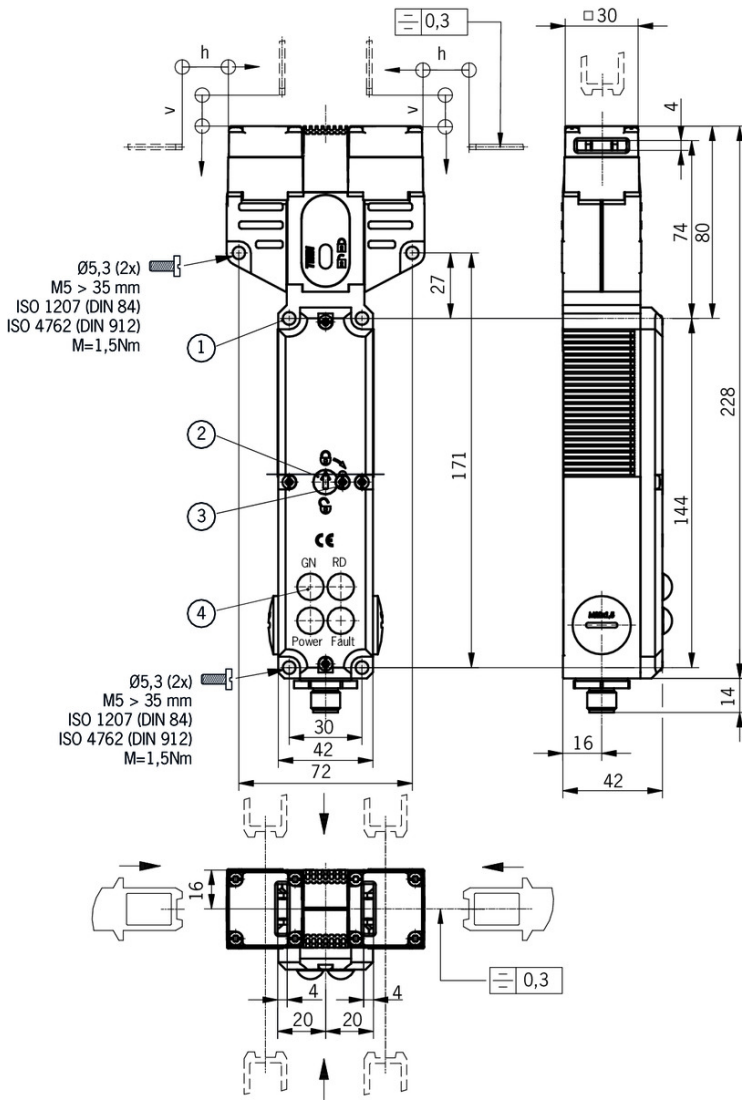

**Legende**

- 1 Do not screw tight here (2x)
- 2 Auxiliary release
- 3 Locking screw
- 4 LED indicator

## Connector assignment

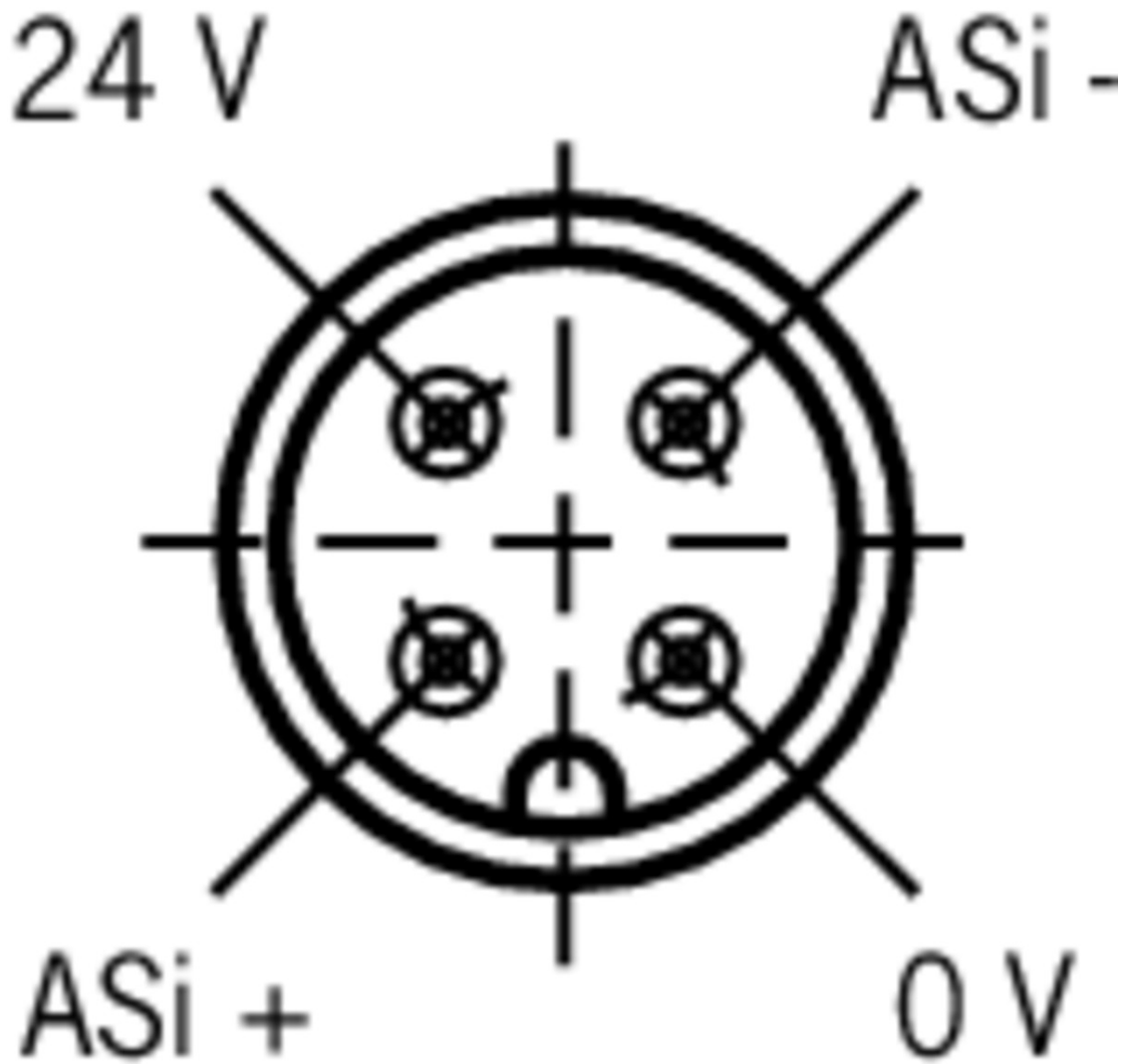

## Legende

View of connection side

## Actuator

- ▼ Hinged actuator S top/bottom for safety switches SGA/SGP/STA/STP/STM



**095315** RADIUSBETAETIGER-S-OU-SN

### ▼ Features

- › Actuators made of stainless steel
- › Two safety screws included
- › For doors hinged at top and bottom

- ▼ Hinged actuator S left/right for safety switches SGA/SGP/STA/STP/STM

**096838** RADIUSBETAETIGER-S-LR-SN



- ✓ Features
    - › Actuators made of stainless steel
    - › Two safety screws included
    - › For doors hinged on right and left
- 

✓ Actuator S for safety switches SGA/SGP/STA/STP/STM



- 095738** BETAETIGER-S-GT-SN
- ✓ Features
    - › Two safety screws included
    - › Actuators with rubber bushings
- 



- 097861** BETAETIGER-S-G-SN-C2115
- ✓ Features
    - › Two safety screws included
    - › Physically compatible with TP actuator P-G
- 

✓ Actuator S, bent, for safety switches SGA/SGP/STA/STP/STM



- 095740** BETAETIGER-S-WQT-SN
- ✓ Features
    - › Two safety screws included
- 

## Function expansion

---

✓ Lock for auxiliary release for safety switches CTP/TP/STP



- 084177** SCHLOSS TP VERSCHIEDENSCHLIESSEND
- ✓ Features
    - › Lock unique locking
    - › Key removable in “unlocked” and “locked” positions
- 



- 109212** SCHLOSS TP GLEICHSCHLIESSEND C2293
- ✓ Features
    - › Identical locking
    - › Key can be removed only in “locked” position
- 



- 086236** SCHLOSS TP GLEICHSCHLIESSEND
- ✓ Features
    - › Identical locking
    - › Key removable in “unlocked” and “locked” positions
- 

✓ Emergency unlocking for safety switches CTP/TP/STP



- 099877** NOTENTSPERRUNG TP/STP
-

- ▼ Release with automatic reset for safety switches CTP/TP/STP



**103110** ENTRIEGELUNG RUECKSTELLEND TP/STP

- ▼ Handle for wire front release



**099795** AY-HDL-099795

- ▼ Features
  - › Suitable for all wire front releases

- ▼ Lockout bar STA/STP/SGA/SGP/STM



**105701** SPERREINSATZ STP/STA

- ▼ Features
  - › Prevents unintentional closing of the door
  - › Can be secured with padlocks

- ▼ Wire front release



**096230** AE-B-A1-02,0-096230

- ▼ Features
  - › Can be used as escape release or emergency unlocking
  - › No automatic return
  - › Sheath length 2 m (rope length 6 m)



**097747** AE-B-A1-02,0-F-097747

- ▼ Features
  - › Can be used as escape release or emergency unlocking
  - › automatic return
  - › Sheath length 2 m (rope length 6 m)



**125582** AE-B-A1-06,0-125582

- ▼ Features
  - › Can be used as escape release or emergency unlocking
  - › No automatic return
  - › Rope length 6 m (without sheath)



**124770** AE-B-A1-06,0-F-124770

- ▼ Features
  - › Can be used as escape release or emergency unlocking
  - › automatic return
  - › Rope length 6 m (without sheath)



**111233** AE-B-A1-03,0-F-111233

- ▼ Features
  - › Can be used as escape release or emergency unlocking
  - › automatic return
  - › Sheath length 3 m (rope length 6 m)



**098314** AE-B-A1-04,0-098314

▼ Features

- › Can be used as escape release or emergency unlocking
- › No automatic return
- › Sheath length 4 m (rope length 6 m)



**098313** AE-B-A1-03,0-098313

▼ Features

- › Can be used as escape release or emergency unlocking
- › No automatic return
- › Sheath length 3 m (rope length 6 m)

## Spare parts

- ▼ Replacement key for mechanical key release



**099434** ERSATZSCHLUESSEL GLEICHSCHL.0354

## Connection material

- ▼ Bus coupling module with plug connector M12, 5-pin





**105756** BCM-A-P2-SEM4-1

▼ Features

- › Conversion from M12 to ribbon cable
- › Very compact design
- › Easy handling



## Instructions

- ▼ Betriebsanleitung Sicherheitsschalter STP-TW...AS1



	Doc. no.	Version	Language	Download
Betriebsanleitung Sicherheitsschalter STP-TW...AS1	102352	04-08/15	 	 2.1 MB
Operating Instructions Safety Switches STP-TW...AS1				

## Catalogs

- ▼ Sicherheitsschalter mit AS-Interface Safety Switches with AS-Interface Interrupteurs de sécurité avec AS-Interface

	Doc. no.	Version	Language	Download
Sicherheitsschalter mit AS-Interface	092164	11-04/17		 2.3 MB



Interrupteurs de sécurité avec AS-Interface	112564	11-04/17		 2.3 MB
Safety Switches with AS-Interface	092332	11-04/17		 2.3 MB

## Declaration of conformity

 EU prohlášení o shodě

	Doc. no.	Version	Language	Download
EU-Konformitätserklärung	2077153	25-02/17		 0.3 MB
Declaración UE de conformidad				
Déclaration UE de conformité				
Dichiarazione di conformità				
EU declaration of conformity				
EU prohlášení o shodě	2077153	25-02/17		 0.5 MB
EU-overensstemmelseserklæring				
Δήλωση συμμόρφωσης της ΕΕ				
EU-vaatimustenmukaisuusvakuutus				
EU-típusbizonyítvány				
EU-conformiteitsverklaring				
Deklaracja zgodności UE				
Declaração de Conformidade UE				
Declarația de conformitate UE				
EÚ vyhlásenie o zhode				