

ITEM 094403 TX1B-A024SEM4AS1

Description	Technical data	Accessories	Downloads
-------------	----------------	-------------	-----------



Guard locking type

TX1 Closed-circuit current principle, guard locking by spring force. Release by control of AS-i output 0.

Control of the guard locking solenoid

The guard locking solenoid is controlled by the control system via AS-Interface bus bit D0. In addition the 24V connection can be switched safely.

AS-Interface inputs

D0, D1 Positively driven NC contact 1 (safety door monitor)
D2, D3 Positively driven NC contact 2 (guard lock monitoring)
Evaluation is performed via a safety monitor.

AS-Interface outputs

D1 Red LED
D2 Green LED

Internal LED function display

- › The Power LED indicates the operating voltage on the bus.
- › The Fault LED indicates if a fault has been detected on the AS-Interface bus.

External LED function display

- › The green and the red LEDs can be controlled as required by the control system via the bus using bits D1 and D2.

Auxiliary release

Is used for releasing the guard locking with the aid of a tool. To protect against tampering, the auxiliary release is sealed with sealing lacquer.

Approvals



Mechanical values and environment

Housing material	Die-cast alloy, cathodically dipped
Weight	Net 0,8 kg
Ambient temperature	-20 ... 50 °C
Degree of protection	IP67
Mechanical life	1 x 10 ⁶
Contact material	Silver alloy, gold flashed
Switching principle	Slow-action switching contact
Installation position	Any
Number of door position positively driven contacts	
According to As-i Safety at Work	1 D0,D1 [1]
Number of guard lock monitoring positively driven contacts	
According to As-i Safety at Work	1 D2,D3 [2]
Connection	
1 x	Plug connector M12 [3]
Approach speed	
max.	20 m/min
Actuation frequency	1200 1/h
Guard locking principle	Closed-circuit current principle
Retention force	20 N
Extraction force	35 N
Actuating force	35 N
Insertion depth	32 mm

Electrical connection ratings

ASi voltage	22,5 ... 30 V 31,6 V
ASi operating current	max.45 mA
ASi auxiliary voltage	
IEC 60742, PELV	24 V -15% ... +10%
ASi auxiliary current	300 mA
Solenoid duty cycle	100 %
ASi slave type	
According to ASI specification 2.1	EA code: 7
According to ASI specification 2.1	ID code: B
ASi data in	
According to ASI safety at work	D0,D1,D2,D3 [4]
ASi data out	
Guard locking solenoid	D0 [5]
LED red	D1 [6]
LED green	D2 [7]

Reliability values acc. to EN ISO 13849-1

B10 _D	6×10^6
------------------	-----------------

in combination with Actuator BETAETIGER-X-GQ, 079740

Mechanical values and environment

Overtravel	1 mm
------------	------

in combination with Actuator BETAETIGER-X-GNQ, 079742, 098082, 097906

Mechanical values and environment

Overtravel	8 mm
------------	------

[1] 1 = Door closed

[2] 1 = Locked

[3] 4-pin

[4] See positively driven NC contact

[5] 1 = Solenoid energized

[6, 7] 1 = LED on

Dimension drawing

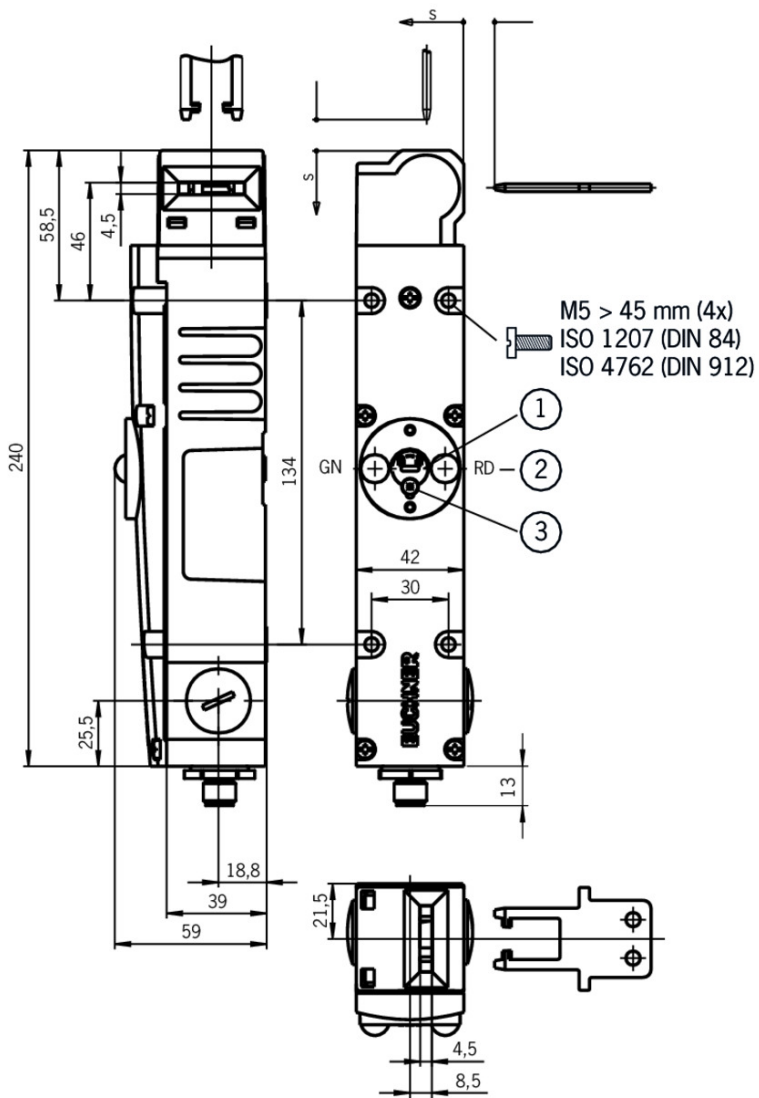

Legende

- 1 Auxiliary release
- 2 LED indicator
- 3 Locking screw

Connector assignment

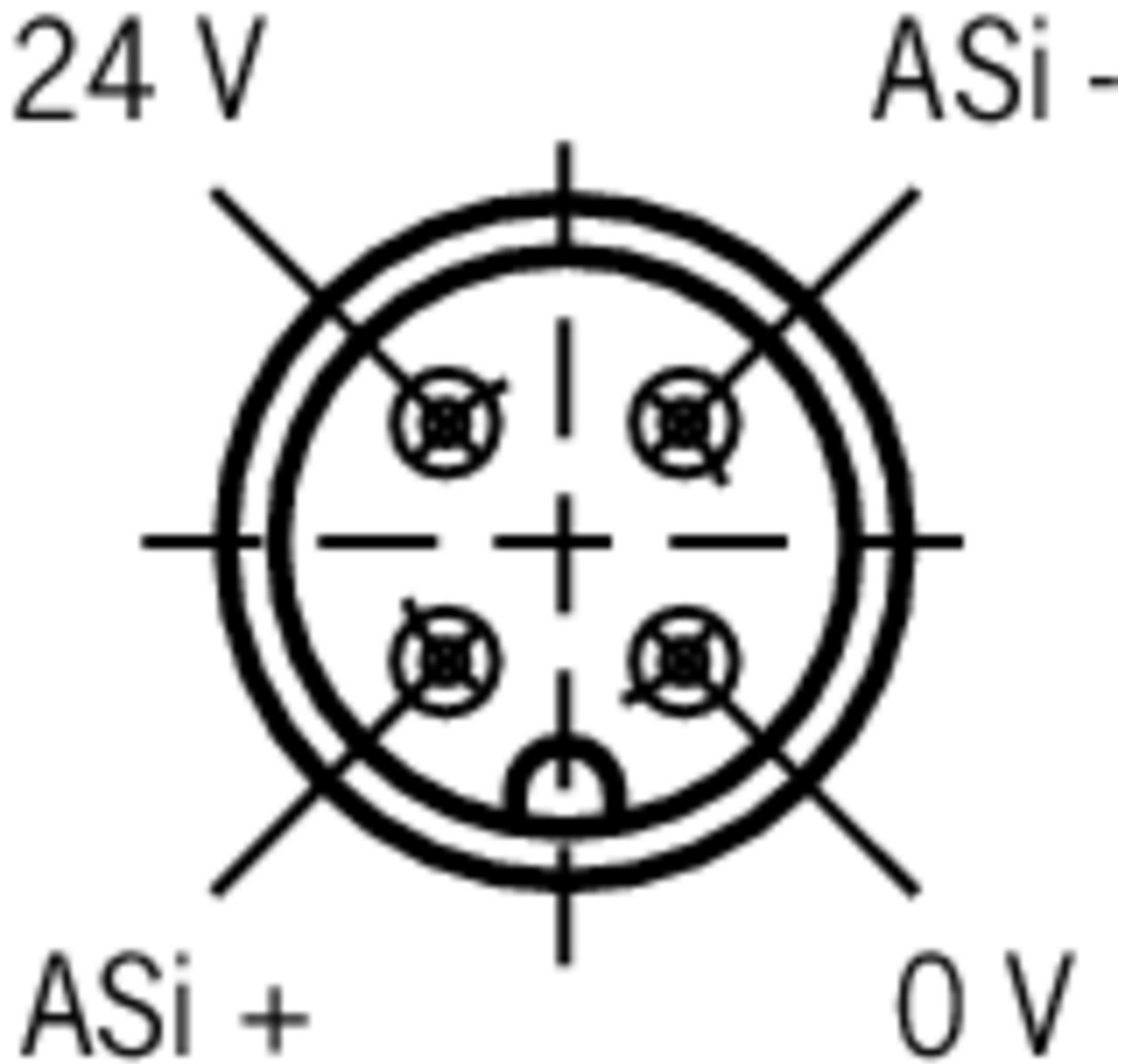

Legende

View of connection side

Function expansion

✓ Lock for mechanical release for safety switches TX



079795 SCHLOSS TX GLEICHSCHLIESSEND



079796 SCHLOSS TX VERSCHIEDENSCHLIESSEND

✓ Release with automatic reset for safety switches TX

094773 ENTRIEGELUNG RUECKSTELLEND TX1/3



Lockout mechanism NX/TX



096098 SPERREINSATZ TX

Features

- › Prevents unintentional closing of the door
- › Can be secured with padlocks



Emergency unlocking for safety switches TX



094771 NOTENTSPERRUNG TX

Mounting accessories



Mounting plates EMP-B2 for actuators for safety switches CTP, TP...A, STA, STP, TX and TZ



093458 EMP-B2



Mounting plates EMP-B1 for actuators for safety switches CTP, TP...A, STA, STP, TX and TZ



093457 EMP-B1



Mounting plates EMP-SB for safety switches CTP, TP...A, STA, STP and TX



093456 EMP-SB

Features

- › For vertical and horizontal mounting of safety switches TP...A, STA, STP and TX

Bolt



Bolt TX-C for safety switches TX and NX



082991 RIEGEL TX-C

Features

- › Steel bolt
- › For doors hinged on the left
- › Can be locked in open position with padlocks
- › Actuator and switch bracket included



Bolt TX-A for safety switches TX and NX



082990 RIEGEL TX-A

Features

- › Steel bolt
 - › For doors hinged on the right
 - › Can be locked in open position with padlocks
 - › Actuator and switch bracket included
-

Actuator

- ▼ Hinged actuator top/bottom for safety switches NX/TX



097906 RADIUSBETAETIGER-X-OU-N

▼ Features

- › Actuators made of stainless steel
 - › Two stainless safety screws per actuator
-

- ▼ Hinged actuator left/right for safety switches NX/TX



098082 RADIUSBETAETIGER-X-LR-N

▼ Features

- › Actuators made of stainless steel
 - › Two stainless safety screws per actuator
-

- ▼ Bent actuator for safety switches NX/TX, increased overtravel



079742 BETAETIGER-X-WNQ

▼ Features

- › Actuators made of stainless steel
 - › Two stainless safety screws per actuator
 - › With rubber bush
-

- ▼ Actuators for safety switches NX/TX, increased overtravel



079741 BETAETIGER-X-GNQ

▼ Features

- › Actuators made of stainless steel
 - › Two stainless safety screws per actuator
 - › With rubber bush
-

- ▼ Actuators for safety switches NX/TX



079739 BETAETIGER-X-GQ

▼ Features

- › Actuators made of stainless steel
 - › Two stainless safety screws per actuator
 - › With rubber bush
-

- ▼ Bent actuator for safety switches NX/TX

079740 BETAETIGER-X-WQ

▼ Features



- › Actuators made of stainless steel
- › Two stainless safety screws per actuator
- › With rubber bush

Connection material

- ✓ Bus coupling module with plug connector M12, 5-pin



105756 BCM-A-P2-SEM4-1

- ✓ Features

- › Conversion from M12 to ribbon cable
- › Very compact design
- › Easy handling

Instructions

- ✓ Betriebsanleitung Sicherheitsschalter TX...AS1

	Doc. no.	Version	Language	Download
Betriebsanleitung Sicherheitsschalter TX...AS1 Operating Instructions Safety Switch TX...AS1	094632	05-02/16	 	1.4 MB

Catalogs











- ✓ Sicherheitsschalter mit AS-Interface Safety Switches with AS-Interface Interrupteurs de sécurité avec AS-Interface

	Doc. no.	Version	Language	Download
Sicherheitsschalter mit AS-Interface	092164	11-04/17		2.3 MB
Interrupteurs de sécurité avec AS-Interface	112564	11-04/17		2.3 MB
Safety Switches with AS-Interface	092332	11-04/17		2.3 MB

Declaration of conformity

- ✓ EU prohlášení o shodě

	Doc. no.	Version	Language	Download
EU-Konformitätserklärung Declaración UE de conformidad Déclaration UE de conformité Dichiarazione di conformità EU declaration of conformity	2077153	25-02/17	 	0.3 MB

EU prohlášení o shodě	2077153	25-02/17		 0.5 MB
EU-overensstemmelseserklæring				
Δήλωση συμμόρφωσης της ΕΕ				
EU-vaatimustenmukaisuusvakuutus				
EU-típusbizonyítvány				
EU-conformiteitsverklaring				
Deklaracja zgodności UE				
Declaração de Conformidade UE				
Declarația de conformitate UE				
EÚ vyhlásenie o zhode				

CAD data

CAD data for this item on TraceParts