

ITEM 120547 CES-I-AS2A-U-C04-SC-120547

Description	Technical data	Accessories	Downloads
-------------	----------------	-------------	-----------



Features

- › Very compact design with 3 active faces
- › Integrated diagnostics LEDs
- › Category 4/PL e according to EN ISO 13849-1
- › Plug connector M8, 3-pin
- › Unicode

Approvals



Mechanical values and environment

Dimensions		42 x 25 x 18
Material		
	Rubber support	NBR 80 ±5 Shore
Housing material		Plastic, PBT

Weight		
	Net	0,04 kg
Ambient temperature		-25 ... +65 °C
Degree of protection		IP67
Resilience to vibration		In acc. with EN IEC 60947-5-2
Installation position		Any
Tightening torque		
	Fixing screws	max.0,8 Nm
Switching frequency		max.1 Hz
Connection		M8 plug connector, 3-pin

Electrical connection ratings

ASi voltage		19 ... 31,6 V
ASi operating current		max.50 mA
Rated insulation voltage U _i		300 V
Rated impulse withstand voltage U _{imp}		max.1,5 kV
Degree of contamination (external, according to EN 60947-1)		3
Switch-on time		
	Safety outputs	max.300 ms
ASi slave type		
According to ASI specification 3.0		AE code: 0
According to ASI specification 3.0		ID code: B
ASi data in		
According to As-i Safety at Work		D0 [1]
According to As-i Safety at Work		D1 [2]
According to As-i Safety at Work		D2 [3]
According to As-i Safety at Work		D3 [4]
Safety class		III
Risk time according to EN 60947-5-3		max.260 ms

Operating distance

Repeat accuracy R		
	According to EN 60947-5-2	≤ 10

Miscellaneous

For the approval according to UL the following applies		Operation only with UL class 2 power supply, or equivalent measures
--	--	---

Reliability values acc. to EN ISO 13849-1

		Monitoring of the safety guard position
Category		4
Performance Level		PL e

PFH _D	4.5 x 10 ⁻⁹
------------------	------------------------

Mission time	20
--------------	----

in combination with Actuator CES-A-BDN-06-104730

Operating distance

Switch-on distance	
Approach direction C or D (broad side)	15 mm
Approach direction A or B (front side)	19 mm
Assured operating distance S _{a0}	
Approach direction C or D (broad side)	min.10 mm
Approach direction A or B (front side)	min.14 mm

in combination with Actuator CES-A-BBN-C04-115271

Operating distance

Switch-on distance	
Approach direction C or D (broad side)	11 mm
Approach direction A or B (front side)	15 mm
Assured operating distance S _{a0}	
Approach direction C or D (broad side)	6
Approach direction A or B (front side)	10

in combination with Actuator CES-A-BDN-06-104730, CES-A-BBN-C04-115271

Operating distance

Assured switch-off distance S _{ar}	
In y direction	max.60 mm
In x/z direction	max.40 mm
Switching hysteresis	1 ... 2 mm

[1, 2, 3, 4] Door position

Dimension drawing

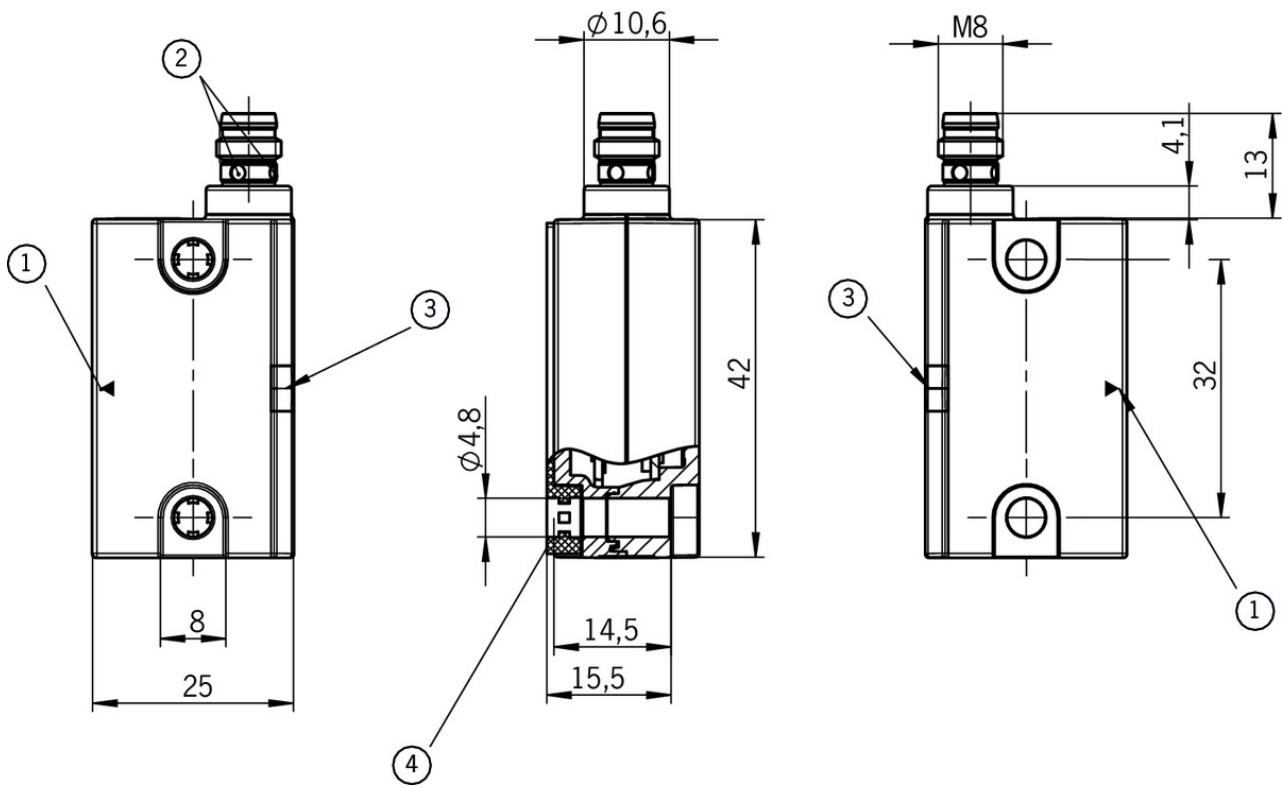

Legende

- 1 Active face
- 2 ASi green/red
- 3 LED status indication
- 4 Rubber support

Wiring diagram

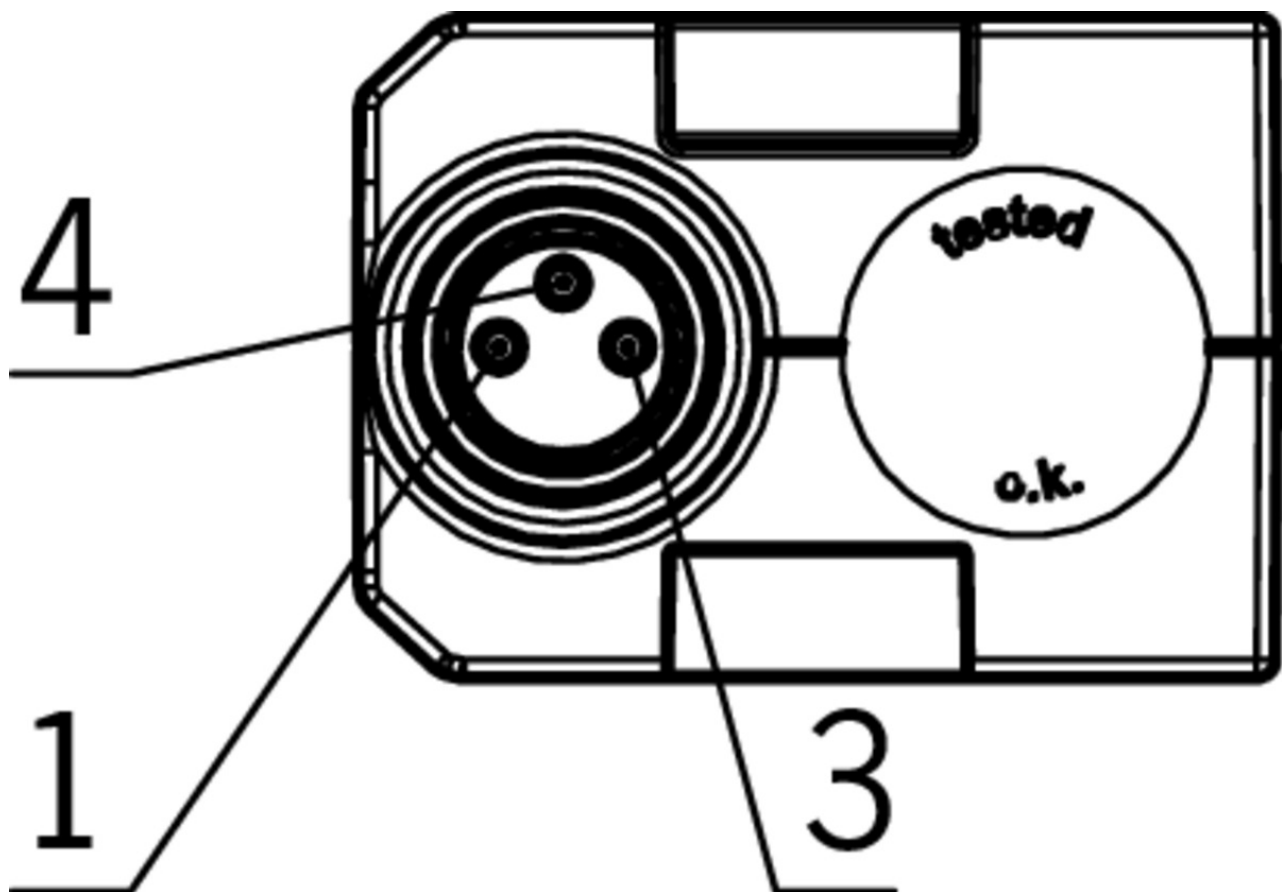

Legende

Pin 1 AS-i +

Pin 3 AS-i -

Pin 4 n.c.

Actuator

Actuator CES-A-BBN-C04



115271 CES-A-BBN-C04-115271

Features

- › Cube-shaped design 42 x 25 mm
- › Two safety screws M4x20 and rubber support included

Actuator CES-A-BDN-06



104730 CES-A-BDN-06-104730

Features

- › Cylindrical design \varnothing 6 mm

Connection material

- ✓ Connection cable with both side plug connector M12, 3-pin and M8, 3-pin, 1m



111600 C-M12M03-03X034PU01,0-M08F03-111600

- ✓ Features

- › M12 male plug, 3-pin
 - › M8 female plug, 3-pin
 - › Straight plug connector
 - › PUR cable
 - › Cable length 1 m
-

- ✓ Bus coupling module with plug connector M12, 5-pin



105756 BCM-A-P2-SEM4-1

- ✓ Features

- › Conversion from M12 to ribbon cable
 - › Very compact design
 - › Easy handling
-

Mounting accessories

- ✓ Safety screws M4 x 20

116978 SICHERHEITSSCHRAUBE M4X20-A2/V20

- ✓ Features

- › Safety screws M4 x 20
 - › Packaging unit 20 pieces
-

Bolt

- ✓ Bolt BTC-CES04-S-TH-20-X-121646 for safety switch CES04



121646 BTC-CES04-S-TH-20-X-121646

- ✓ Features

- › Aluminum bolt
 - › For doors hinged on the left or right
 - › Spring catch in closed position
 - › Can be locked in open position with padlocks
-

- ✓ Bolt BTC-CES04-S-TH-21-F-123583 for safety switch CES04



123583 BTC-CES04-S-TH-21-F-123583





- ✓ Features

- › Aluminum bolt
- › For doors hinged on the left or right
- › Escape release
- › Detent knob in open position
- › Spring catch in closed position



› Can be locked in open position with padlocks

Instructions

▼ Betriebsanleitung Sicherheitsschalter CES-I-AS2A-U-C04 (Unicode)



	Doc. no.	Version	Language	Download
Betriebsanleitung Sicherheitsschalter CES-I-AS2A-U-C04 (Unicode)	2120544	06-08/18		 1.2 MB
Operating Instructions Safety Switch CES-I-AS2A-U-C04 (Unicode)	2120544	06-08/18		 1.2 MB

▼ Sicherheitsinformation und Wartung CES-I-AS2A



	Doc. no.	Version	Language	Download
Sicherheitsinformation und Wartung CES-I-AS2A Safety Information and Maintenance CES-I-AS2A	120543	01-04/14	 	 0.1 MB

Catalogs







▼ Mit integriertem AS-Interface – der neue Sicherheitsschalter CES-AS-C04

	Doc. no.	Version	Language	Download
Mit integriertem AS-Interface – der neue Sicherheitsschalter CES-AS-C04 With integrated AS-Interface – the new safety switch CES-AS-C04	122724	01-08/14	 	 0.3 MB

▼ Con AS-Interface integrado – nuevo interruptor de seguridad CES-AS-C04

	Doc. no.	Version	Language	Download
Con AS-Interface integrado – nuevo interruptor de seguridad CES-AS-C04 Avec AS-Interface intégrée – Le nouvel interrupteur de sécurité CES-AS-C04	122847	01-08/14	 	 0.3 MB

▼ Sicherheitsschalter mit AS-Interface Safety Switches with AS-Interface Interrupteurs de sécurité avec AS-Interface

	Doc. no.	Version	Language	Download
Sicherheitsschalter mit AS-Interface	092164	11-04/17		 2.3 MB
Interrupteurs de sécurité avec AS-Interface	112564	11-04/17		 2.3 MB
Safety Switches with AS-Interface	092332	11-04/17		 2.3 MB

Declaration of conformity

▼ EU-Konformitätserklärung

Doc. no.	Version	Language	Download
----------	---------	----------	----------

EU-Konformitätserklärung
EU declaration of conformity
Declaración UE de conformidad
Déclaration UE de conformité
Dichiarazione di conformità

2138020 02-04/18



 0.4 MB