

**ITEM 120546 CES-I-AS2A-M-C04-SC-120546**

Description	Technical data	Accessories	Downloads
-------------	----------------	-------------	-----------



**Features**

- › Very compact design with 3 active faces
- › Integrated diagnostics LEDs
- › Category 4/PL e according to EN ISO 13849-1
- › Plug connector M8, 3-pin
- › Multicode

**Approvals**



**Mechanical values and environment**

Dimensions	42 x 25 x 18
Material	
	Rubber support NBR 80 ±5 Shore
Housing material	Plastic, PBT

Weight		
	Net	0,04 kg
Ambient temperature		-25 ... +65 °C
Degree of protection		IP67
Resilience to vibration		In acc. with EN IEC 60947-5-2
Installation position		Any
Tightening torque		
	Fixing screws	max.0,8 Nm
Switching frequency		max.1 Hz
Connection		M8 plug connector, 3-pin

### Electrical connection ratings

ASi voltage		19 ... 31,6 V
ASi operating current		max.50 mA
Rated insulation voltage U <sub>i</sub>		300 V
Rated impulse withstand voltage U <sub>imp</sub>		max.1,5 kV
Degree of contamination (external, according to EN 60947-1)		3
Switch-on time		
	Safety outputs	max.300 ms
ASi slave type		
According to ASI specification 3.0		AE code: 0
According to ASI specification 3.0		ID code: B
ASi data in		
According to As-i Safety at Work		D0 <b>[1]</b>
According to As-i Safety at Work		D1 <b>[2]</b>
According to As-i Safety at Work		D2 <b>[3]</b>
According to As-i Safety at Work		D3 <b>[4]</b>
Safety class		III
Risk time according to EN 60947-5-3		max.260 ms

### Operating distance

Repeat accuracy R		
	According to EN 60947-5-2	≤10

### Miscellaneous

For the approval according to UL the following applies		Operation only with UL class 2 power supply, or equivalent measures
--	--	---

### Reliability values acc. to EN ISO 13849-1

		<b>Monitoring of the safety guard position</b>
Category		4
Performance Level		PL e

PFH <sub>D</sub>	4.5 x 10 <sup>-9</sup>
------------------	------------------------

Mission time	20
--------------	----

**in combination with Actuator CES-A-BDN-06-104730**

**Operating distance**

Switch-on distance	
Approach direction C or D (broad side)	15 mm
Approach direction A or B (front side)	19 mm
Assured operating distance S <sub>a0</sub>	
Approach direction C or D (broad side)	min.10 mm
Approach direction A or B (front side)	min.14 mm

**in combination with Actuator CES-A-BBN-C04-115271**

**Operating distance**

Switch-on distance	
Approach direction C or D (broad side)	11 mm
Approach direction A or B (front side)	15 mm
Assured operating distance S <sub>a0</sub>	
Approach direction C or D (broad side)	10
Approach direction A or B (front side)	6

**in combination with Actuator CES-A-BDN-06-104730, CES-A-BBN-C04-115271**

**Operating distance**

Assured switch-off distance S <sub>ar</sub>	
In y direction	max.60 mm
In x/z direction	max.40 mm
Switching hysteresis	1 ... 2 mm

[1, 2, 3, 4] Door position

## Dimension drawing

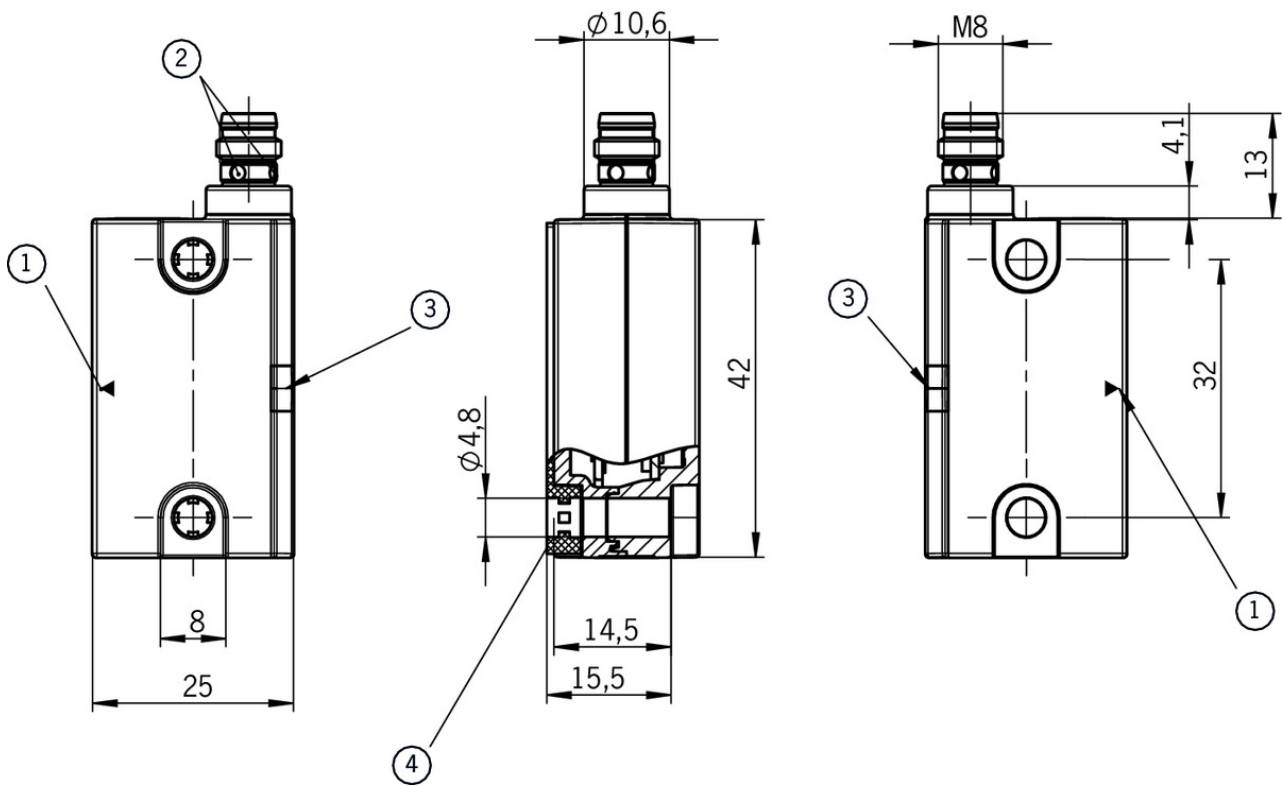

## Legende

- 1 Active face
- 2 ASi green/red
- 3 LED status indication
- 4 Rubber support

## Wiring diagram

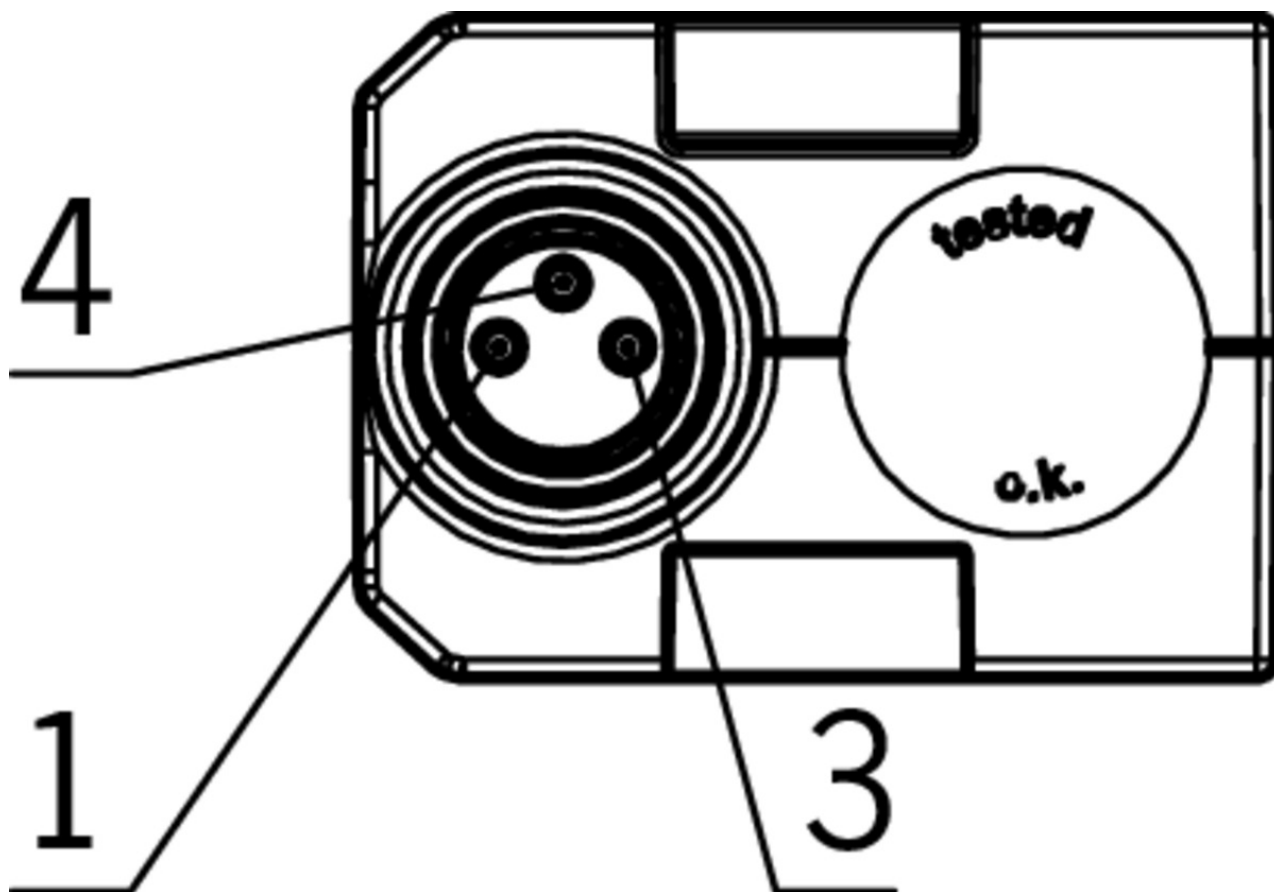

### Legende

Pin 1 AS-i +

Pin 3 AS-i -

Pin 4 n.c.

## Actuator

### Actuator CES-A-BBN-C04



**115271** CES-A-BBN-C04-115271

#### Features

- › Cube-shaped design 42 x 25 mm
- › Two safety screws M4x20 and rubber support included

### Actuator CES-A-BDN-06



**104730** CES-A-BDN-06-104730

#### Features

- › Cylindrical design  $\varnothing$  6 mm

## Connection material

---

- ✓ Connection cable with both side plug connector M12, 3-pin and M8, 3-pin, 1m



**111600** C-M12M03-03X034PU01,0-M08F03-111600

- ✓ Features

- › M12 male plug, 3-pin
  - › M8 female plug, 3-pin
  - › Straight plug connector
  - › PUR cable
  - › Cable length 1 m
- 

- ✓ Bus coupling module with plug connector M12, 5-pin



**105756** BCM-A-P2-SEM4-1

- ✓ Features

- › Conversion from M12 to ribbon cable
  - › Very compact design
  - › Easy handling
- 

## Mounting accessories

---

- ✓ Safety screws M4 x 20

**116978** SICHERHEITSSCHRAUBE M4X20-A2/V20

- ✓ Features

- › Safety screws M4 x 20
  - › Packaging unit 20 pieces
- 

## Bolt

---

- ✓ Bolt BTC-CES04-S-TH-20-X-121646 for safety switch CES04



**121646** BTC-CES04-S-TH-20-X-121646

- ✓ Features

- › Aluminum bolt
  - › For doors hinged on the left or right
  - › Spring catch in closed position
  - › Can be locked in open position with padlocks
- 

- ✓ Bolt BTC-CES04-S-TH-21-F-123583 for safety switch CES04



**123583** BTC-CES04-S-TH-21-F-123583





- ✓ Features

- › Aluminum bolt
- › For doors hinged on the left or right
- › Escape release
- › Detent knob in open position
- › Spring catch in closed position



› Can be locked in open position with padlocks

## Instructions

### ▼ Betriebsanleitung Berührungsloser Sicherheitsschalter CES-I-AS2A-M-C04 (Multicode)



	Doc. no.	Version	Language	Download
Betriebsanleitung Berührungsloser Sicherheitsschalter CES-I-AS2A-M-C04 (Multicode)	2120545	05-08/18		 1.2 MB
Operating Instructions Non-Contact Safety Switch CES-I-AS2A-M-C04 (Multicode)	2120545	05-08/18		 1.2 MB

### ▼ Sicherheitsinformation und Wartung CES-I-AS2A



	Doc. no.	Version	Language	Download
Sicherheitsinformation und Wartung CES-I-AS2A Safety Information and Maintenance CES-I-AS2A	120543	01-04/14	 	 0.1 MB

## Catalogs







### ▼ Mit integriertem AS-Interface – der neue Sicherheitsschalter CES-AS-C04

	Doc. no.	Version	Language	Download
Mit integriertem AS-Interface – der neue Sicherheitsschalter CES-AS-C04 With integrated AS-Interface – the new safety switch CES-AS-C04	122724	01-08/14	 	 0.3 MB

### ▼ Con AS-Interface integrado – nuevo interruptor de seguridad CES-AS-C04

	Doc. no.	Version	Language	Download
Con AS-Interface integrado – nuevo interruptor de seguridad CES-AS-C04 Avec AS-Interface intégrée – Le nouvel interrupteur de sécurité CES-AS-C04	122847	01-08/14	 	 0.3 MB

### ▼ Sicherheitsschalter mit AS-Interface Safety Switches with AS-Interface Interrupteurs de sécurité avec AS-Interface

	Doc. no.	Version	Language	Download
Sicherheitsschalter mit AS-Interface	092164	11-04/17		 2.3 MB
Interrupteurs de sécurité avec AS-Interface	112564	11-04/17		 2.3 MB
Safety Switches with AS-Interface	092332	11-04/17		 2.3 MB

## Declaration of conformity

### ▼ EU-Konformitätserklärung

Doc. no.	Version	Language	Download
----------	---------	----------	----------

EU-Konformitätserklärung  
EU declaration of conformity  
Declaración UE de conformidad  
Déclaration UE de conformité  
Dichiarazione di conformità

2138020 02-04/18



 0.4 MB