

ITEM 116246 RIEGEL CES-AC/F-AP-C01-AH-SB-116246

Description	Technical data	Accessories	Downloads
-------------	----------------	-------------	-----------



Features

- › Steel bolt
- › For doors hinged on the left or right
- › Lever for escape release from the danger area
- › Safety switch already pre-assembled
- › With safety plate
- › Connection via M12 plug connector
- › Protective plate for safety switch
- › Pushbutton in open position
- › Ball detent mechanism in closed position
- › Can be locked in open position with padlocks
- › Switch and actuator included

Advantages

- › Robust construction
- › Easily fitted to standard aluminum profiles and machine covers by screw connection
- › Distinctive yellow color for easy recognition
- › Symmetrical design for doors hinged on the right or left
- › No additional door handle necessary

Notes

- › CES actuator integrated in the bolt tongue
 - › Safety switch CES-AP-C01-AH-SB-111145 included. For further information see product page for the safety switch.
-

Special features

- › Uniquely coded actuator (one-off)- maximum protection against tampering
- › Bolt with detent mechanism- bolt latches in open position to prevent unintentional closing
- › Ball detent mechanism in closed bolt position- protection against vibration

Components included in the set



111145 Safety switch CES-AP-C01-AH-SB-111145

▼ Features

Mechanical values and environment

Material	Handle	Plastic
	Guide strips	Plastic
	Base plate	Galvanized steel
	Switch bracket	Steel powder-coated
Weight	Net	2 kg
	Escape release	Yes
Number of safety switches that can be fitted		1

Miscellaneous

Detent mechanism	Open position	Bolt detent mechanism
	Closed position	Ball detent mechanism

Dimension drawing

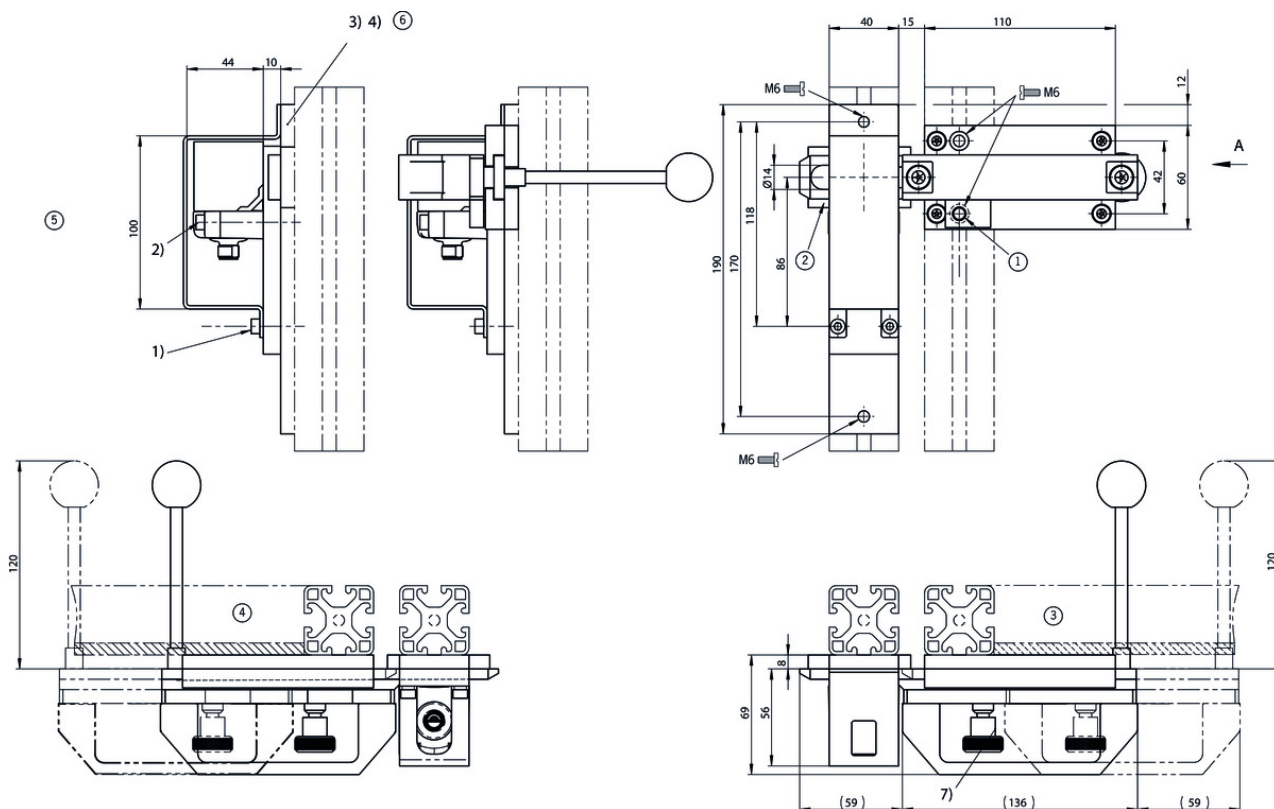

Legende

- 1 Detent mechanism against accidental opening (vibration)
- 2 Safety plate
- 3 Door hinged on the right
- 4 Door hinged on the left
- 5 Changing the approach direction
- 1) Undo the screws M5x10 (1)
- 2) Undo the fixing screws on the CES-...
- 3) Turn the stop plate
- 4) Mounting in reverse order
- 6 Stop plate
- 7) Bolt with detent mechanism. Engages in open position. (Prevents unintentional closing of the bolt) Unlocked by pulling the detent knob upward.

Instructions

- Návod k použití Bezkontaktní bezpečnostní spínač CES-AP-C01-... (Unicode/Multicode)

Betriebsanleitung Berührungsloser Sicherheitsschalter CES-AP-C01-... (Uni-/Multicode)	2112663	06-10/17		1.5 MB
Mode d'emploi Interrupteur de sécurité sans contact CES-AP-C01-... (uni-/multicode)	2112663	06-10/17		1.5 MB
Manual de instrucciones Interruptor de seguridad sin contacto CES-AP-C01-... (Unicode/Multicode)	2112663	06-10/17		1.5 MB
Návod k použití Bezkontaktní bezpečnostní spínač CES-AP-C01-... (Unicode/Multicode)	2112663	06-10/17		1.6 MB
Operating Instructions Non-Contact Safety Switch CES-AP-C01-... (Unicode/Multicode)	2112663	06-10/17		1.5 MB
Kezelési útmutató Érintkezésmentes biztonsági kapcsoló CES-AP-C01-... (uni-/multikód)	2112663	06-10/17		1.6 MB
Istruzioni di impiego Finecorsa di sicurezza senza contatto CES-AP-C01-... (Unicode/Multicode)	2112663	06-10/17		1.5 MB
Instrukcja obsługi Bezstykowy wyłącznik bezpieczeństwa CES-AP-C01-... (Uni-/Multicode)	2112663	06-10/17		1.6 MB
Инструкция по эксплуатации Бесконтактный предохранительный выключатель CES-AP-C01-... (Uni-/Multicode)	2112663	06-10/17		1.7 MB
Návod na prevádzku Bezdotykový bezpečnostný spínač CES-AP-C01-... (Uni-/Multicode)	2112663	06-10/17		1.6 MB
使用说明书 非接触式安全开关 CES-AP-C01-... (特殊/通用编码)	2112663	06-10/17		1.7 MB
Manual de instruções Chaves de segurança sem contato CES-AP-C01-... (Unicode/Multicode)	2112663	06-10/17		1.5 MB

Sicherheitsinformation CES-AR/CES-AP







	Doc. no.	Version	Language	Download
Sicherheitsinformation CES-AR/CES-AP	091181	08-04/15		0.6 MB
Información de seguridad CES-AR/CES-AP				
Information de sécurité CES-AR/CES-AP				
Informazioni sulla sicurezza CES-AR/CES-AP				
Safety Information CES-AR/CES-AP				
Informații privind siguranța CES-AR/CES-AP	091181	08-04/15		0.2 MB
Информация о безопасности CES-AR/CES-AP	091181	08-04/15		0.2 MB
Informação de segurança CES-AR/CES-AP	091181	08-04/15		0.2 MB
Bezpečnostní informace CES-AR/CES-AP	091181	08-04/15		0.2 MB
安全信息 CES-AR/CES-AP	091181	08-04/15		0.3 MB
Güvenlik bilgisi CES-AR/CES-AP	091181	08-04/15		0.2 MB

Sicherheitsinformation CES-AR/CES-AP/CES-BR

	Doc. no.	Version	Language	Download
Sicherheitsinformation CES-AR/CES-AP/CES-BR	2514431	02-07/18		0.4 MB
Safety Information CES-AR/CES-AP/CES-BR				
Information de sécurité CES-AR/CES-AP/CES-BR				

Catalogs

-  Transpondercodierte Sicherheitsschalter - Verriegelungseinrichtungen und Zuhaltungen
 Transponder-coded safety switches - Interlocking devices and guard locking devices
 Interruptores de seguridad con codificación por transponder - Dispositivos de enclavamiento y bloqueos
 Interrupteurs de sécurité à codage par transpondeur - Dispositifs de verrouillage et interverrouillages







	Doc. no.	Version	Language	Download
Transpondercodierte Sicherheitsschalter - Verriegelungseinrichtungen und Zuhaltungen	127594	02-01/18		 5.2 MB
Interrupteurs de sécurité à codage par transpondeur - Dispositifs de verrouillage et interverrouillages	137558	02-01/18		 5.2 MB
Interruptores de seguridad con codificación por transponder - Dispositivos de enclavamiento y bloqueos	137560	02-01/18		 5.2 MB
Transponder-coded safety switches - Interlocking devices and guard locking devices	127595	02-01/18		 5.1 MB

Declaration of conformity

-  EU prohlášení o shodě

	Doc. no.	Version	Language	Download
EU-Konformitätserklärung Declaración UE de conformidad Déclaration UE de conformité Dichiarazione di conformità EU declaration of conformity	2109923	13-01/17	    	 0.4 MB
EU prohlášení o shodě EU-overensstemmelseserklæring Δήλωση συμμόρφωσης της ΕΕ EU-vaatimustenmukaisuusvakuutus EU-típusbizonyítvány EU-conformiteitsverklaring Deklaracja zgodności UE Declarația de conformitate UE EÚ vyhlásenie o zhode	2109923	13-01/17	     	 0.6 MB

-  EU-Konformitätserklärung

	Doc. no.	Version	Language	Download
EU-Konformitätserklärung Declaración UE de conformidad Déclaration UE de conformité Dichiarazione di conformità EU declaration of conformity	2138160	01-01/17	    	 0.3 MB

CAD data

CAD data for this item on TraceParts