

## ITEM 122406 CET3-AP-CRA-AH-50X-SA-122406

Description	Technical data	Accessories	Downloads
-------------	----------------	-------------	-----------



### Features

- › Safety switch with guard locking and integrated evaluation electronics
- › Locking force up to 6500 N
- › Short circuit monitoring
- › 2 safety outputs (semiconductor outputs)
- › Up to category 4/PL e according to EN ISO 13849-1
- › With 1 plug connector M12, 8-pin
- › Unicode
- › Door monitoring output
- › Indication of the door position by LED
- › Monitoring output DIA
- › Approach direction A (default setting on delivery)

### Approach direction

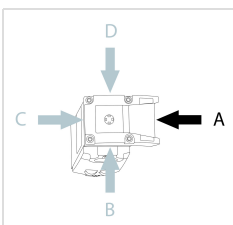

› Figure

Horizontal  
Can be adjusted in 90° steps

---

### Safety switch

The device may be operated only in conjunction with the actuator CET-A-....  
**Important:** The actuator must be ordered separately.

---

### Unicode evaluation

Each actuator is unique. The switch detects only taught-in actuators. Additional actuators can be taught in. Only the last actuator taught in is detected.

---

### Solenoid operating voltage

› DC 24 V +10% -15%

---

### Guard locking type

**CET3 Closed-circuit current principle**, guard locking by spring force.  
Release by applying voltage to the guard locking solenoid. The door position is also monitored. The door monitoring output OUT D is set to HIGH as soon as the actuator is above the extended plunger (state: door closed, guard locking not active). The output OUT D remains set also with guard locking active.

---

### LED function display

**LED State** Status LED  
**LED DIA** Diagnostic LED  
**LED 1 rd** illuminates when the solenoid is energized  
**LED 2 gn** illuminates when door is closed

---

### Additional connections

**DIA** Monitoring output (semiconductor)  
**OUT D** Door monitoring output  
**RST** Reset input

---

### Category according to EN ISO 13849-1

Due to two redundantly designed semiconductor outputs (safety outputs) with internal monitoring suitable for:

› Category 4/PL e according to EN ISO 13849-1

**Important:** To achieve the stated category in accordance with EN ISO 13849-1, both safety outputs (OA and OB) must be evaluated.

The category is dependent on the installation position of the safety switch:

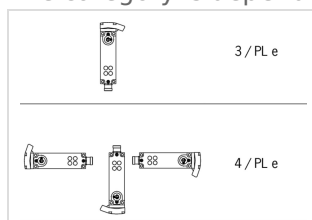

› Figure

## Approvals



## Mechanical values and environment

Housing material		
	Slide	Stainless steel
	Safety switch housing	Die-cast aluminum
Weight		
	Net	1 kg
Ambient temperature		
	At $U_B = 24V DC$	-20 ... 55 °C
Degree of protection		IP67 [1]
Resilience to vibration		In acc. with EN IEC 60947-5-2
Mechanical life		$1 \times 10^6$
Installation position		Any [2]
Degree of freedom		
	Z	$\pm 4$ mm
	Y	$\pm 5$ mm
	X	$\pm 5$ mm
Ready delay		1 s
Switching frequency		max.0,5 Hz
Connection		1 plug connector M12, 8-pin
Approach speed		20 m/min
Guard locking principle		Closed-circuit current principle
Locking force $F_{max}$		6500 N
Locking force $F_{Zh}$		5000 N [3]

## Electrical connection ratings

Operating voltage DC		
	$U_B$	24 V DC -15% ... 15% Reverse polarity protected, regulated, residual ripple < 5%, PELV [4]
	LED	24 V DC -15% ... 10%
Current consumption		
	$I_B$	80 mA
	$I_{CM}$	480 mA
Utilization category according to EN 60947-5-2		
	DC-13	24V 200mA [5]
Solenoid operating voltage DC		

	U <sub>CM</sub>	24 V DC -15% ... +10% Reverse polarity protected, regulated, residual ripple < 5%, PELV
Fusing		
External (operating voltage U <sub>B</sub> )		0,25 ... 2 A
External (solenoid operating voltage U <sub>CM</sub> )		0,5 ... 8 A
Power consumption		
	Solenoid	max.12 W
EMC protection requirements		In acc. with EN IEC 60947-5-3
Solenoid duty cycle		100 %
Degree of contamination (external, according to EN 60947-1)		3
Connecting cable		30V DC, 2A [6]
Safety class		
	EN IEC 61140	III
Switching load		
	According to UL	24V DC, class 2 [7]
<b>Safety outputs OA/OB</b>		
Type of output		2 semiconductor outputs, p-switching, short circuit-proof
Switching current		
Per safety output OA / OB		1 ... 200 mA
Output voltage		
High U(OA) / U(OB)		U <sub>B</sub> -1,5V ... U <sub>B</sub> V DC
Low U(OA) / U(OB)		0 ... 1 V DC
Off-state current I <sub>r</sub>		max.0,25 mA
Risk time according to EN 60947-5-3		
Single device		max.400 ms
Switch-on time		400 ms
Discrepancy time		
Both safety outputs		max.10 ms
<b>Monitoring output DIA</b>		
Type of output		p-switching, short circuit-proof
Switching current		
DIA		1 ... 50 mA
Output voltage		
DIA		0,8xU <sub>B</sub> ... U <sub>B</sub> V DC
Switching delay from state change		max.400 ms
<b>Monitoring output OUT D</b>		
Type of output		p-switching, short circuit-proof
Switching current		
OUT D		1 ... 50 mA
Output voltage		
OUT D		0,8xU <sub>B</sub> ... U <sub>B</sub> V DC
Switching delay from state change		max.700 ms

## Operating distance

Repeat accuracy R According to EN 60947-5-2	10 %
--	------

## Miscellaneous

For the approval according to UL the following applies	Operation only with UL class 2 power supply, or equivalent measures see operating instructions
--	--

## Reliability values acc. to EN ISO 13849-1

	<b>Monitoring of guard locking and the safety guard position</b>
Category	
Head upward	3
Head downward or horizontal	4
Performance Level	PL e
PFH <sub>D</sub>	
Head upward	$4.29 \times 10^{-8}$
Head downward or horizontal	$3.1 \times 10^{-9}$
	<b>Control of the guard locking</b>
Category	Depending on external control of guard locking
Performance Level	Depending on external control of guard locking
PFH <sub>D</sub>	Depending on external control of guard locking

---

Mission time	20 y
--------------	------

[1] Screwed tight plug connector/mating component

[2] Preferably head downward

[3]  $FZH = FMAX/1.3$

[4] The device tolerates voltage interruptions of up to 5ms

[5] Caution: outputs must be protected with a free-wheeling diode in case of inductive loads

[6] For UL requirement UL category code (CYJV/CYJV7)

[7] For alternatives see operating instructions

# Dimension drawing

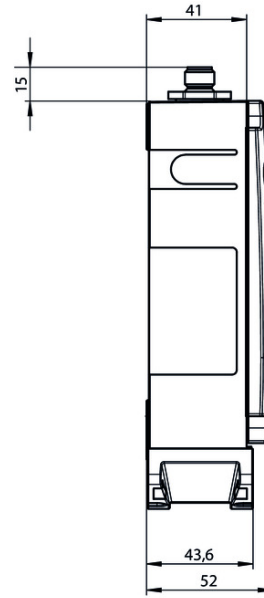
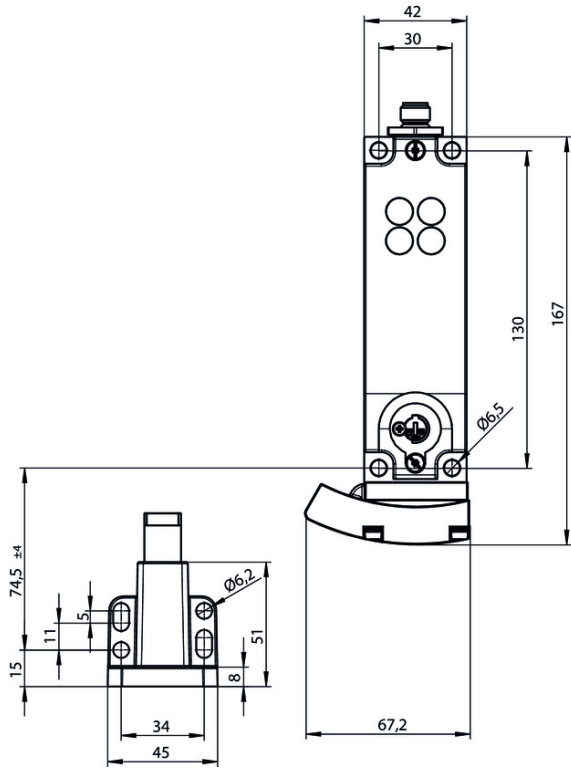
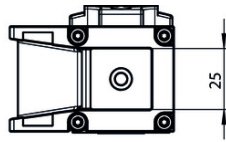

## Wiring diagram

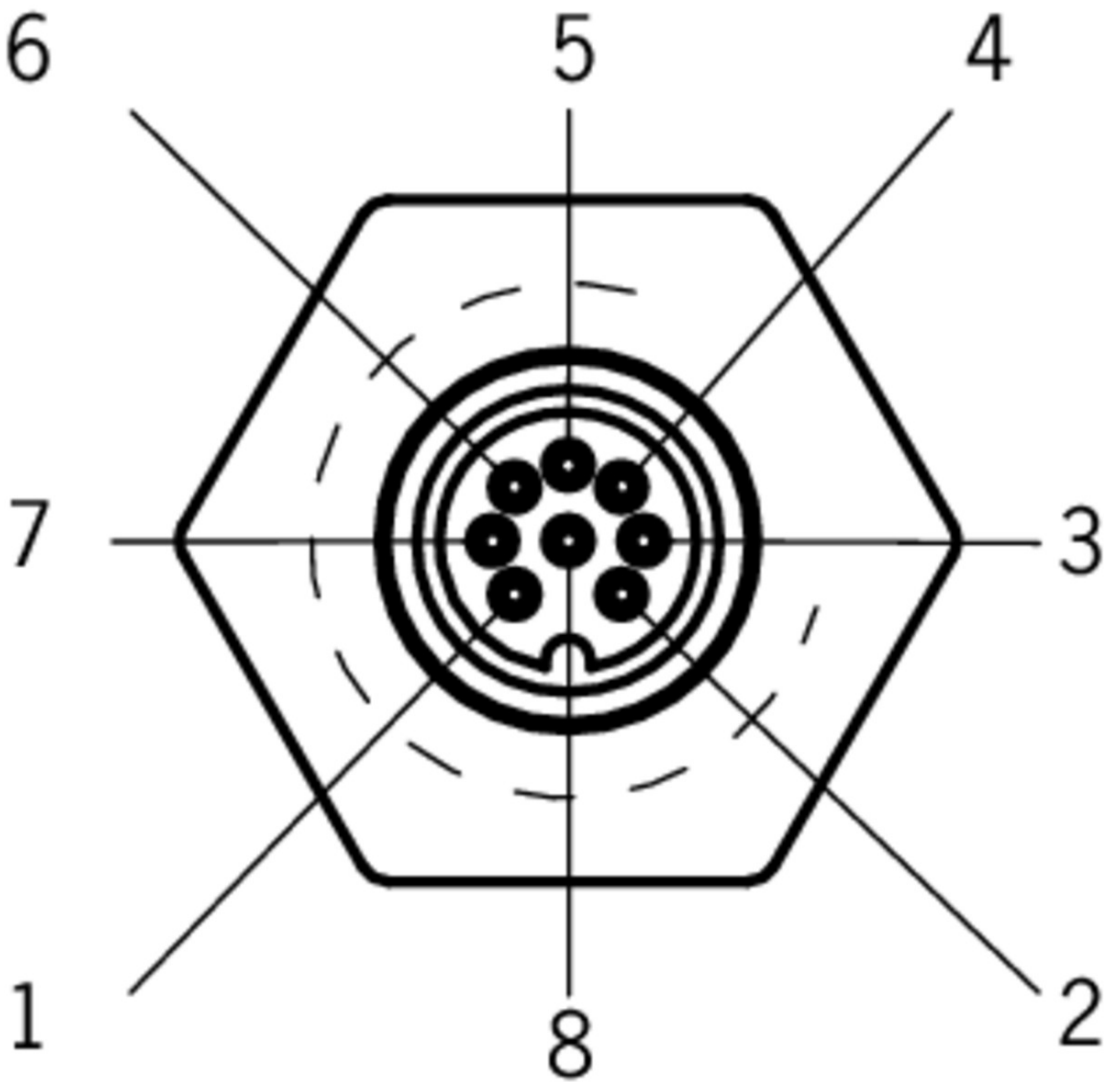

## Block diagram

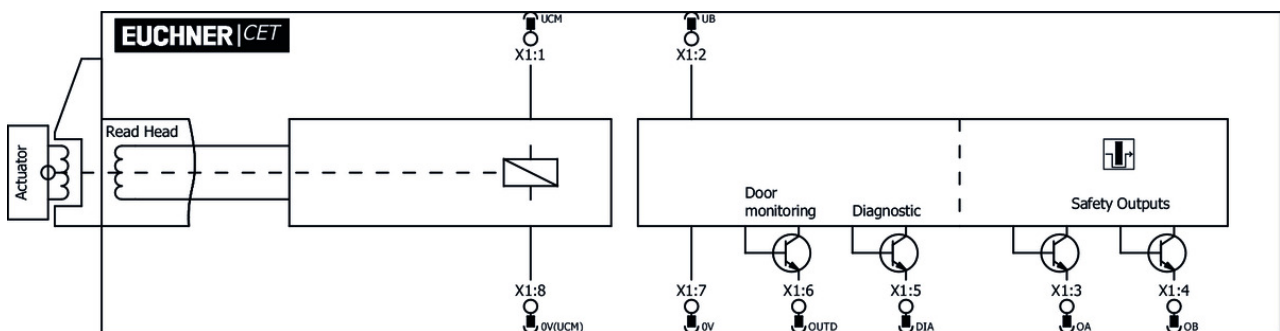

## Actuator

Actuator CET-A-BWK-50X



**096327** CET-A-BWK-50X

### Features

- Actuator for read head/safety switch CET
- Four safety screws M5x16 included

---

## Function expansion

---

▼ Mechanical key release for CET read head/switch



**098850** SCHLUESSEL-HILFSENTRIEGELUNG

▼ Features

- › Identical locking
- › Key removable in “unlocked” and “locked” positions

---

▼ Emergency unlocking for CET



**103714** NOTENTSPERRUNG CET

---

▼ Cover for read head and actuator CET



**098808** CET ABDECKUNG RECHTS

▼ Features

- › Cover for read heads / safety switches CET and actuators CET
- › For approach direction A



**098807** CET ABDECKUNG LINKS

▼ Features

- › Cover for read heads / safety switches CET and actuators CET
- › For approach direction C

---

▼ Cover for actuator CET



**124979** AM-C-124979

▼ Features

- › Cover for actuator CET
- › Horizontal and vertical fastening option on the actuator
- › Mounting using 4 screws M5x16 (included with the actuator)
- › Not suitable in combination with lockout bar for actuator CET

---

▼ Lockout mechanism for CET actuator



**122609** AE-L-CET-122609

▼ Features

- › Prevents unintentional closing of the door
- › Can be secured with padlocks
- › Not suitable in combination with cover AM-C for actuator CET



**156429** AE-L-CET-156429

▼ Features

- › Prevents unintentional closing of the door
  - › Can be secured with padlocks
-



▼ Holder for lockout mechanism CET actuator



**156338** Y-CHN-A1-156338

▼ Features

- › Holder (incl. wire rope) for lockout bar CET

▼ Lockout bar and holder for CET actuators



**155865** AE-SET-LCHN-A1-155865

▼ Features

- › Prevents unintentional closing of the door
- › Can be secured with padlocks

▼ Double ramp for safety switch/read head CET



**114091** CET-DR

## Mounting accessories

▼ Mounting plate EMP-L-... for CET read head/switches



**106695** EMP-L-CET

▼ Features

- › Mounting plate for CET read heads/switches
- › For hinged or sliding doors
- › Suitable for aluminum profiles 40 ... 45 mm
- › Horizontal and vertical mounting
- › Suitable for CET with escape release

▼ Mounting plate EM-P switch for safety switch CET



**126399** AM-P-126399

▼ Features

- › Mounting plate for CET read heads/switches
- › Direct mounting on aluminum profiles of width 30/40/50 mm
- › Suitable for the mounting plates AM-P-126400 and AM-P-126398

▼ Mounting plate EM-P actuator for safety switch CET



**126400** AM-P-126400

▼ Features

- › Mounting plate for CET actuator
- › Suitable for mounting on aluminum profiles of width 30/40/50 mm
- › Suitable for the mounting plates AM-P-126399 and AM-P-126398

▼ Mounting plate EM-P handle for safety switch CET



### **126398** AM-P-126398

#### ▼ Features

- › Mounting plate with handle (handle included)
  - › For hinged or sliding doors
  - › Horizontal and vertical assembly circuits possible
  - › Suitable for aluminum profiles of width 30/40/50 mm
  - › Suitable for the CET mounting plates AM-P-126399 and AM-P-126400
- 

#### ▼ Mounting plate EMP-B-... for actuator CET



### **106694** EMP-B-CET

#### ▼ Features

- › Mounting plate for actuator CET for hinged or sliding doors
  - › Suitable for aluminum profiles 40 ... 45 mm
  - › Horizontal and vertical mounting
  - › Made of aluminum
- 

## Bolt

---

#### ▼ Bolt CET-A-C



### **104309** RIEGEL CET-A-C

#### ▼ Features

- › Steel bolt
  - › In combination with CET
  - › For left or right hinged doors
  - › Can be locked in open position with padlocks
- 



### **109672** RIEGEL CET-A-C-C2308

#### ▼ Features

- › Steel bolt
  - › In combination with CET
  - › For left or right hinged doors
  - › Can be locked in open position with padlocks
  - › Bolt without door stop, suitable for swing doors
- 

## Connection material

---

#### ▼ Connection cable with plug connector M12, 8-pin, 30m



### **115116** C-M12F08-08X025PV30,0-MA-115116

#### ▼ Features

- › M12 female plug, 8-pin
  - › Straight plug connector
  - › PVC cable
  - › Cable length 30 m
  - › With flying lead
- 



### **115257** C-M12F08-08X025PU30,0-MA-115257

#### ▼ Features

- › M12 female plug, 8-pin
  - › Straight plug connector
  - › PUR cable
  - › Cable length 30 m
  - › With flying lead
- 

✓ Connection cable with plug connector M12, 8-pin, 20m



**100179** C-M12F08-08X025PV20,0-MA-100179

✓ Features

- › M12 female plug, 8-pin
  - › Straight plug connector
  - › PVC cable
  - › Cable length 20 m
  - › With flying lead
- 



**115114** C-M12F08-08X025PU20,0-MA-115114

✓ Features

- › M12 female plug, 8-pin
  - › Straight plug connector
  - › PUR cable
  - › Cable length 20 m
  - › With flying lead
- 

✓ Connection cable with plug connector M12, 8-pin, 10m



**100178** C-M12F08-08X025PV10,0-MA-100178

✓ Features

- › M12 female plug, 8-pin
  - › Straight plug connector
  - › PVC cable
  - › Cable length 10 m
  - › With flying lead
- 



**115113** C-M12F08-08X025PU10,0-MA-115113

✓ Features

- › M12 female plug, 8-pin
  - › Straight plug connector
  - › PUR cable
  - › Cable length 10 m
  - › With flying lead
- 

✓ Connection cable with plug connector M12, 8-pin, 5m



**100177** C-M12F08-08X025PV05,0-MA-100177

✓ Features

- › M12 female plug, 8-pin
  - › Straight plug connector
  - › PVC cable
  - › Cable length 5 m
  - › With flying lead
-



**115112** C-M12F08-08X025PU05,0-MA-115112

▼ Features

- › M12 female plug, 8-pin
  - › Straight plug connector
  - › PUR cable
  - › Cable length 5 m
  - › With flying lead
- 

▼ Connection cable with angled plug connector M12, 8-pin, 20m



**120998** C-M12F08-08X025PU20,0-MA-120998

▼ Features

- › M12 female plug, 8-pin
  - › Angled plug connector
  - › Cable outlet A (right)
  - › PUR cable
  - › Cable length 20 m
  - › With flying lead
- 



**120999** C-M12F08-08X025PU20,0-MA-120999

▼ Features

- › M12 female plug, 8-pin
  - › Angled plug connector
  - › Cable outlet C (left)
  - › PUR cable
  - › Cable length 20 m
  - › With flying lead
- 

▼ Connection cable with angled plug connector M12, 8-pin, 10m



**113188** C-M12F08-08X025PU10,0-MA-113188

▼ Features

- › M12 female plug, 8-pin
  - › Angled plug connector
  - › Cable outlet A (right)
  - › PUR cable
  - › Cable length 10 m
  - › With flying lead
- 













**113189** C-M12F08-08X025PU10,0-MA-113189



















▼ Features

- › M12 female plug, 8-pin
  - › Angled plug connector
  - › Cable outlet C (left)
  - › PUR cable
  - › Cable length 10 m
  - › With flying lead
-

▼ Betriebsanleitung Transpondercodierter Sicherheitsschalter mit Zuhaltung CET.-AP-... (Uni-/Multicode)

	Doc. no.	Version	Language	Download
Betriebsanleitung Transpondercodierter Sicherheitsschalter mit Zuhaltung CET.-AP-... (Uni-/Multicode)	2122242	04-05/18		 2.5 MB
Mode d'emploi Interrupteur de sécurité à codage par transpondeur avec interverrouillage CET.-AP-... (uni-/multicode)	2122242	04-05/18		 2.6 MB
Manual de instrucciones Interruptor de seguridad con codificación por transponder con bloqueo CET.-AP-... (Unicode/Multicode)	2122242	04-05/18		 2.6 MB
Operating Instructions Transponder-Coded Safety Switch With Guard Locking CET.-AP-... (Unicode/Multicode)	2122242	04-05/18		 2.5 MB
Istruzioni di impiego Finecorsa di sicurezza con codifica a transponder con meccanismo di ritenuta CET.-AP-... (Unicode/Multicode)	2122242	04-05/18		 2.5 MB
使用说明书 应答机编码安全开关 CET.-AP-... (特殊/通用编码)	2122242	04-05/18		 2.9 MB

▼ Bezpečnostní informace CET (-AR/-AP)

	Doc. no.	Version	Language	Download
Sicherheitsinformation CET (-AR/-AP) Información de seguridad CET (-AR/-AP) Information de sécurité CET (-AR/-AP) Informazioni sulla sicurezza CET (-AR/-AP) Safety Information CET (-AR/-AP)	105517	14-01/17	    	 0.7 MB
Bezpečnostní informace CET (-AR/-AP)	105517	14-01/17		 0.2 MB
Informação de segurança CET (-AR/-AP)	105517	14-01/17		 0.2 MB
Güvenlik bilgisi CET (-AR/-AP)	105517	14-01/17		 0.3 MB
安全情報 CET (-AR/-AP)	105517	14-01/17		 0.6 MB
Информация о безопасности CET (-AR/-AP)	105517	14-01/17		 0.3 MB
安全信息 CET (-AR/-AP)	105517	14-01/17		 0.3 MB

## Catalogs





▼ Transpondercodierte Sicherheitsschalter - Verriegelungseinrichtungen und Zuhaltungen  
Transponder-coded safety switches - Interlocking devices and guard locking devices  
Interruptores de seguridad con codificación por transponder - Dispositivos de enclavamiento y bloqueos  
Interrupteurs de sécurité à codage par transpondeur - Dispositifs de verrouillage et interverrouillages

	Doc. no.	Version	Language	Download
Transpondercodierte Sicherheitsschalter - Verriegelungseinrichtungen und Zuhaltungen	127594	02-01/18		 5.2 MB
Interrupteurs de sécurité à codage par transpondeur - Dispositifs de verrouillage et interverrouillages	137558	02-01/18		 5.2 MB

Interruptores de seguridad con codificación por transponder - Dispositivos de enclavamiento y bloqueos	137560	02-01/18		 5.2 MB
Transponder-coded safety switches - Interlocking devices and guard locking devices	127595	02-01/18		 5.1 MB

## Declaration of conformity

### EU-Konformitätserklärung

	Doc. no.	Version	Language	Download
EU-Konformitätserklärung	2110802	10-01/17		 0.3 MB
Declaración UE de conformidad				
Déclaration UE de conformité				
Dichiarazione di conformità				
EU declaration of conformity			