

ITEM 095221 RIEGEL TP-CF-NIRO

Description	Technical data	Accessories	Downloads
-------------	----------------	-------------	-----------



Features

- › Stainless steel bolt
- › For doors hinged on the left
- › Escape release
- › Detent knob in open position
- › Can be locked in open position with padlocks
- › Actuator included

Advantages

- › Robust construction
- › Easily fitted to standard aluminum profiles and machine covers by screw connection
- › No additional door handle necessary

Version in stainless steel

- › Suitable for use in the chemical and foodstuff industries
- › Screw material stainless steel
- › Handle material polypropylene
- › Handle and slide strips made of stainless steel

› Slide strip material polyethylene

Mechanical values and environment

Material		
	Handle	Plastic
	Guide strips	Stainless steel
	Base plate	Stainless steel
	Switch bracket	Stainless steel
Weight		
	Net	2,25 kg
Escape release		Yes
Number of safety switches that can be fitted		1

Miscellaneous

Detent mechanism		
	Open position	Bolt detent mechanism

Dimension drawing

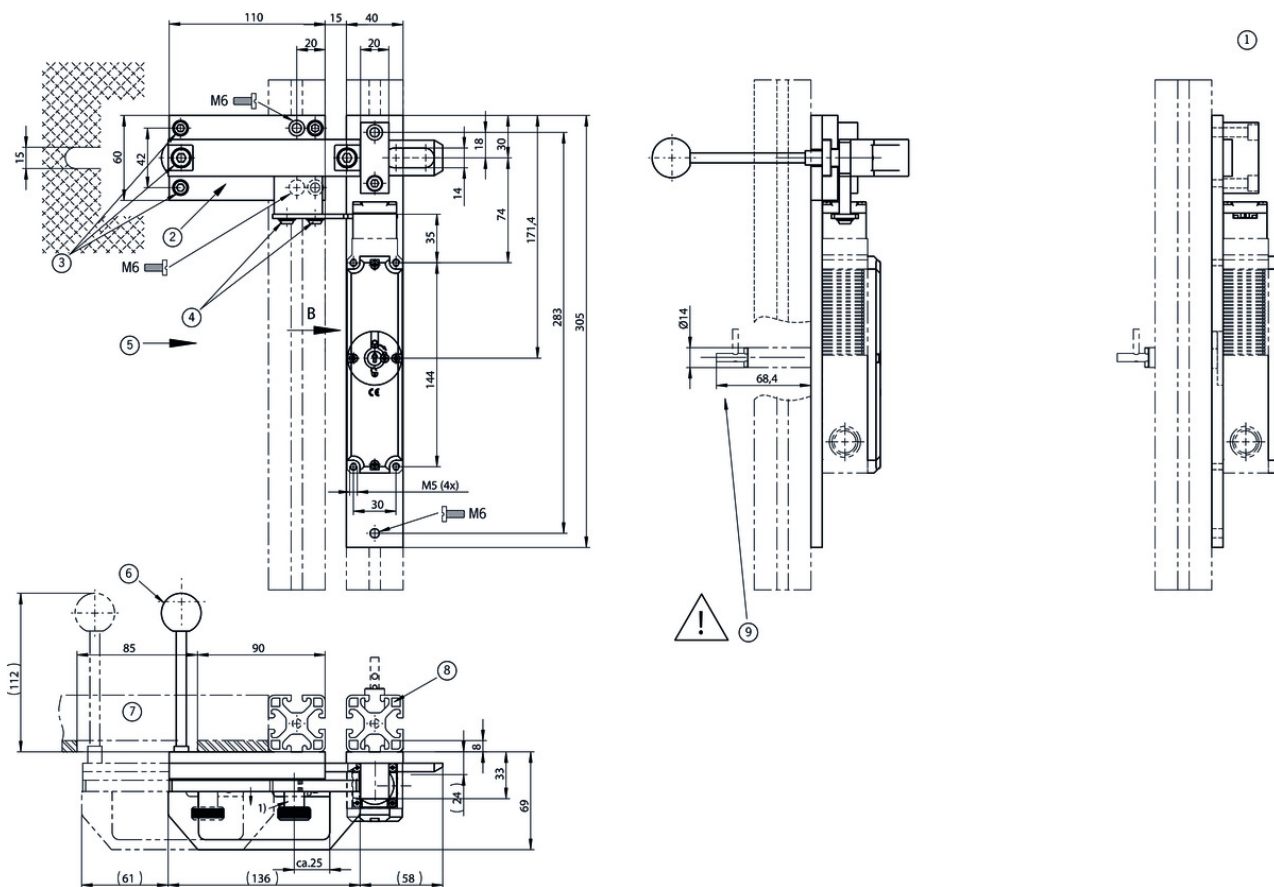













Legende

- 1 View B
- 2 Bolt, fixation bar and individual parts (screws, washers...) made of stainless steel + handle made of GFRP
- 3 Screw secured with ball
- 4 Safety screw
- 5 Safety switch TP... Approach direction C
- 6 Included loose
- 7 Door hinged on the left
- 8 Safety guard frame (40x40)
- 9 On the actuation of the escape release for the switch, the actuator must not be subjected to a tensile load (e.g. due to strain on the doors or pulling the lever for the bolt)
- 1) Bolt with detent mechanism. Engages in open position. (Prevents unintentional closing of the bolt) Unlocked by pulling the detent knob upward

Catalogs

- ✓ Bezpečnostní spínače s plastovým pouzdem Sicherheitsschalter mit Kunststoffgehäuse Safety Switches with Plastic Housing Interruptores de seguridad con carcasa plástica Interrupteurs de

sécurité avec boîtier plastique 塑料壳体 的安全开关

	Doc. no.	Version	Language	Download
Sicherheitsschalter mit Kunststoffgehäuse	096955	11-03/18		 6.6 MB
Interrupteurs de sécurité avec boîtier plastique	100677	11-03/18		 6.6 MB
Interruptores de seguridad con carcasa plástica	104855	11-03/18		 6.6 MB
Bezpečnostní spínače s plastovým pouzdem	121649	11-03/18		 6.6 MB
Safety Switches with Plastic Housing	096956	11-03/18		 6.6 MB
塑料壳体 的安全开关	116243	11-03/18		 6.2 MB