

ITEM 123376 CTP-L1-AP-M-HA-AE-SH-123376

Description	Technical data	Accessories	Downloads
-------------	----------------	-------------	-----------



Features

- › Safety switch with guard locking and integrated evaluation electronics
- › Short circuit monitoring
- › 2 safety outputs (semiconductor outputs)
- › Up to category 4/PL e according to EN ISO 13849-1
- › With plug connector M23
- › Multicode
- › Door monitoring output
- › With escape release
- › Approach direction A, B and C (default setting on delivery)

Approach direction

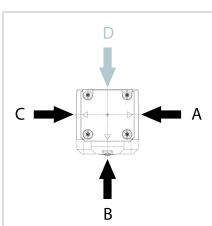

- › Figure
Horizontal
Can be adjusted in 90° steps

Multicode evaluation

Every suitable actuator is detected by the switch.



Guard locking type

CTP-L1 Guard locking actuated by spring force applied and power-ON released (closed-circuit current principle)

Escape release

This is used for manual release of guard locking from within the danger area without tools.

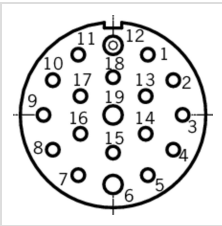
Connector assignment

Plug connector (view of connection side)	Pin	Designation	Function	Conductor coloring of connection cable
	1	IMP	Operating voltage of guard locking solenoid, 24 V DC	VT
	2	-	n.c.	RD
	3	-	n.c.	GY
	4	FO1A	Safety output, channel 1 	RD/BU
	5	FO1B	Safety output, channel 2 	GN
	6	UB	Operating voltage of AP electronics, 24 V DC	BU
	7	RST	Reset input	GY/PK
	8	OD	Door monitoring output	GN/WH
	9	OI	Diagnostics output	YE/WH
	10	OL	Guard locking monitoring output	GY/WH
	11	-	n.c.	BK
	12	FE	Function earth (must be connected to meet the EMC requirements)	GN/YE
	13	-	n.c.	PK
	14	-	n.c.	BN/GY
	15	-	n.c.	BN/YE
	16	-	n.c.	BN/GN

Plug connector (view of connection side)	Pin	Designation	Function	Conductor coloring of connection cable
	17	-	n.c.	WH
	18	IMM	Operating voltage of guard locking solenoid 0 V	YE
	19	0 V UB	Operating voltage of AP electronics, 0 V	BN

Approvals



Mechanical values and environment

Housing material	
Switch head cover	Die-cast zinc
Safety switch housing	Fiber glass reinforced thermoplastic
Weight	
	Net 0,42 kg
Ambient temperature	
At $U_B = 24V$ DC	-20 ... +55 °C
Degree of protection	IP67 [1]
Resilience to vibration	In acc. with EN IEC 60947-5-3
Mechanical life	1×10^6
Installation position	Any
Ready delay	max.1 s
Switching frequency	max.0,5 Hz
Connection	1 plug connector M23, 19-pin, RC18
Approach speed	20 m/min
Guard locking principle	Closed-circuit current principle
Locking force F_{max}	3900 N
Locking force F_{Zh}	3000 N [2]
Retention force	20 N
Extraction force	20 N
Actuating force	10 N
Overtravel	5 mm

Electrical connection ratings

Test-pulse interval	min.100 ms
Test pulses	max.0,3 ms [3]

Operating voltage DC	U_{UB}	24 V DC -15% ... 15% Reverse polarity protected, regulated, residual ripple < 5%, PELV
Current consumption	I_{UB} I_{IMP}	40 mA 400 mA
Utilization category according to EN 60947-5-2	DC-13	24V 150mA [4]
Solenoid operating voltage DC	U_{IMP}	24 V DC -15% ... +10% Reverse polarity protected, regulated, residual ripple < 5%, PELV
Fusing		
External (operating voltage U_B)		0,25 ... 2 A
External (solenoid operating voltage U_{IMP})		0,5 ... 8 A
Rated insulation voltage U_i		max.50 V
Rated impulse withstand voltage U_{imp}		max.0,5 kV
Power consumption		6 W
EMC protection requirements		In acc. with EN IEC 60947-5-3
Solenoid duty cycle		100 %
Degree of contamination (external, according to EN 60947-1)		3
Safety class	EN IEC 61140	III
Switching load	According to UL	24V DC, class 2 [5]
		Safety outputs FO1A / FO1B
Type of output		2 semiconductor outputs, p-switching, short circuit-proof
Switching current		
Per safety output FO1A / FO1B		1 ... 150 mA
Output voltage		
High $U(FO1A)$ / $U(FO1B)$		$U_B - 1,5 \dots U_B$ V DC
Low $U(FO1A)$ / $U(FO1B)$		0 ... 1 V DC
Off-state current I_r		max.0,25 mA
Switch-on time		max.400 ms
Discrepancy time		
Both safety outputs		In acc. with EN IEC 60947-5-3 max.10 ms
		Monitoring output OL
Type of output		p-switching, short circuit-proof
Switching current		1 ... 50 mA
Output voltage		0,8x U_B ... U_B V DC
		Monitoring output OD
Type of output		p-switching, short circuit-proof
Switching current		1 ... 50 mA
Output voltage		0,8x U_B ... U_B V DC
		Monitoring output OI

Type of output	p-switching, short circuit-proof
Switching current	1 ... 50 mA
Output voltage	0,8xUB ... UB V DC

Operating distance

Repeat accuracy R According to EN 60947-5-2	10 %
--	------

Miscellaneous

Additional feature	Escape release actuated by pushing
For the approval according to UL the following applies	Operation only with UL class 2 power supply, or equivalent measures see operating instructions

Reliability values acc. to EN ISO 13849-1

Performance Level	PL e
Category	4
PFH _D	4.1 x 10 ⁻⁹
Mission time	20 y

[1] Screwed tight plug connector/mating component

[2] $F_{zh} = F_{max}/1.3$ Depending on the actuator used

[3] Applies for a load with $C \leq 30\text{nF}$ and $R \leq 20\text{k}\Omega$

[4] Caution: outputs must be protected with a free-wheeling diode in case of inductive loads

[5] Alternatively see operating instructions

Dimension drawing

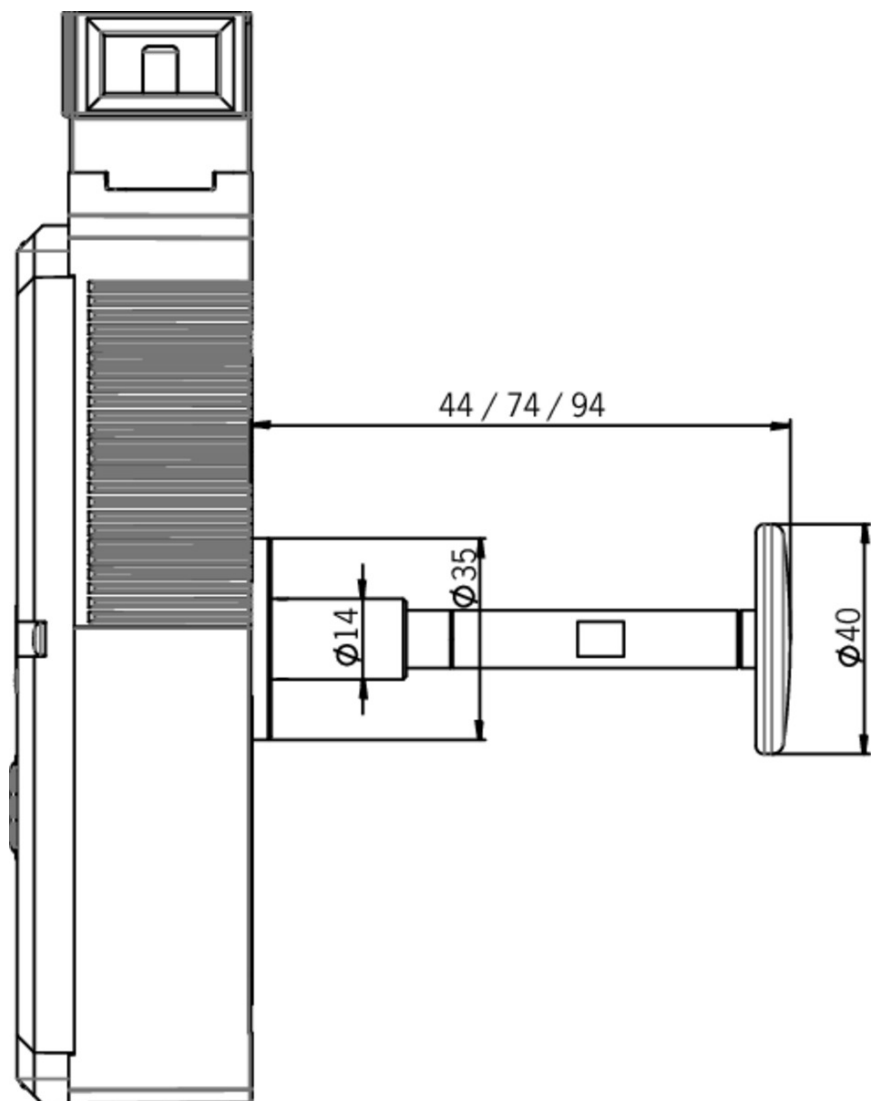

Dimension drawing

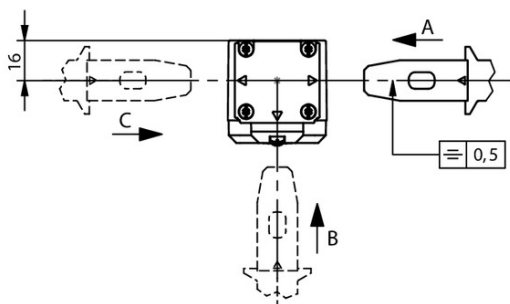
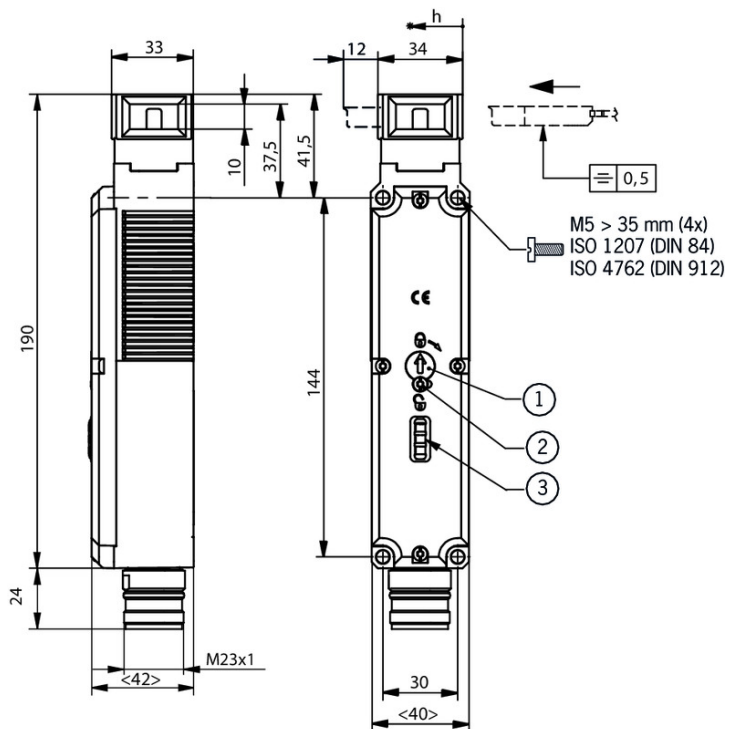

Legende

- 1 Auxiliary release
- 2 Locking screw
- 3 LEDs

Wiring diagram

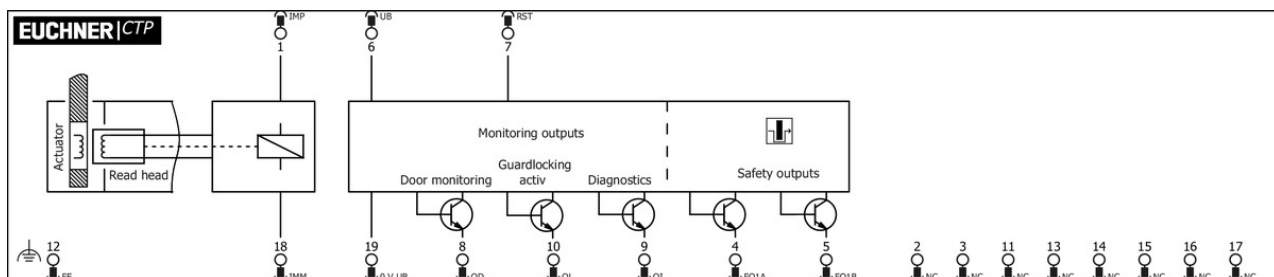

Function expansion

☑ Handle for wire front release



124204 AY-HDL-124204

☑ Features

- › Suitable for all wire front releases
-



099795 AY-HDL-099795

☑ Features

- › Suitable for all wire front releases
-

☑ Lockout mechanism CTP



123411 AE-L-C-H-123411

☑ Features

- › Prevents unintentional closing of the door
 - › Can be secured with padlocks
-

☑ Lock for auxiliary release for safety switches CTP/TP/STP



084177 SCHLOSS TP VERSCHIEDENSCHLIESSEND

☑ Features

- › Lock unique locking
 - › Key removable in “unlocked” and “locked” positions
-



109212 SCHLOSS TP GLEICHSCHLIESSEND C2293

☑ Features

- › Identical locking
 - › Key can be removed only in “locked” position
-



086236 SCHLOSS TP GLEICHSCHLIESSEND

☑ Features

- › Identical locking
 - › Key removable in “unlocked” and “locked” positions
-

☑ Emergency unlocking for safety switches CTP/TP/STP



099877 NOTENTSPERRUNG TP/STP

☑ Release with automatic reset for safety switches CTP/TP/STP



103110 ENTRIEGELUNG RUECKSTELLEND TP/STP

☑ Wire front release

096230 AE-B-A1-02,0-096230



✓ Features

- › Can be used as escape release or emergency unlocking
- › No automatic return
- › Sheath length 2 m (rope length 6 m)



098313 AE-B-A1-03,0-098313

✓ Features

- › Can be used as escape release or emergency unlocking
- › No automatic return
- › Sheath length 3 m (rope length 6 m)



097747 AE-B-A1-02,0-F-097747

✓ Features

- › Can be used as escape release or emergency unlocking
- › automatic return
- › Sheath length 2 m (rope length 6 m)



124770 AE-B-A1-06,0-F-124770

✓ Features

- › Can be used as escape release or emergency unlocking
- › automatic return
- › Rope length 6 m (without sheath)



111233 AE-B-A1-03,0-F-111233

✓ Features

- › Can be used as escape release or emergency unlocking
- › automatic return
- › Sheath length 3 m (rope length 6 m)



098314 AE-B-A1-04,0-098314

✓ Features

- › Can be used as escape release or emergency unlocking
- › No automatic return
- › Sheath length 4 m (rope length 6 m)



125582 AE-B-A1-06,0-125582

✓ Features

- › Can be used as escape release or emergency unlocking
- › No automatic return
- › Rope length 6 m (without sheath)

Actuator

✓ Bent actuator for safety switches CTP



122667 A-C-H-W-SST-122667

✓ Features

- › Actuator bent at top
- › Two safety screws included



122668 A-C-H-W-SST-122668

✓ Features

- › Actuator bent at bottom
- › Two safety screws included

✓ Hinged actuator for safety switch CTP



122675 A-C-H-RO-LS-122675

✓ Features

- › Hinged actuator for doors hinged at the top
- › Two safety screws included



122676 A-C-H-RU-LS-122676

✓ Features

- › Hinged actuator for doors hinged at the bottom
- › Two safety screws included



122671 A-C-H-RL-LS-122671

✓ Features

- › Hinged actuator for doors hinged on the left
- › Two safety screws included



122672 A-C-H-RR-LS-122672

✓ Features

- › Hinged actuator for doors hinged on the right
- › Two safety screws included

✓ Straight actuator for safety switch CTP



126015 A-C-H-G-SST-126015

✓ Features

- › Straight actuator
- › Two safety screws included

Mounting accessories

✓ Mounting plates EMP-SB for safety switches CTP, TP...A, STA, STP and TX



093456 EMP-SB

✓ Features

- › For vertical and horizontal mounting of safety switches TP...A, STA, STP and TX

✓ Mounting plates EMP-B2 for actuators for safety switches CTP, TP...A, STA, STP, TX and TZ



093458 EMP-B2

- ▼ Mounting plates EMP-B1 for actuators for safety switches CTP, TP...A, STA, STP, TX and TZ



093457 EMP-B1

- ▼ Mounting plates AM-P for safety switches CTP



126026 AM-P-126026

- ▼ Features

- › For vertical and horizontal mounting of safety switch CTP

Connection material

- ▼ Connection cable with plug connector M23 with option C1825, 8m, angled



085195 C-M23F19-19XDIFPU08,0-MA-085195

- ▼ Features

- › M23 plug connector, 18-pin + PE
- › Angled plug connector
- › Cable exit A (right)
- › PUR cable
- › Cable length 8 m
- › With flying lead
- › Cores color-coded



077019 C-M23F19-19XDIFPU08,0-MA-077019

- ▼ Features

- › RC18 plug connector, 18-pin + PE
- › Angled plug connector
- › Cable exit C (left)
- › PUR cable
- › Cable length 8 m
- › With flying lead
- › Cores color-coded

- ▼ Connection cable with plug connector M23 with option C1825, 10m, angled



092902 C-M23F19-19XDIFPU10,0-MA-092902

- ▼ Features

- › M23 plug connector, 18-pin + PE
- › Angled plug connector
- › Cable exit A (right)
- › PUR cable
- › Cable length 10 m
- › With flying lead
- › Cores color-coded



092901 C-M23F19-19XDIFPU10,0-MA-092901

- ▼ Features

- › M23 plug connector, 18-pin + PE
- › Angled plug connector

- › Cable exit C (left)
 - › PUR cable
 - › Cable length 10 m
 - › With flying lead
 - › Cores color-coded
-

▼ Connection cable with plug connector M23 with option C1825, 25m, angled



092913 C-M23F19-19XDIFPU25,0-MA-092913

▼ Features

- › M23 plug connector, 18-pin + PE
 - › Angled plug connector
 - › Cable exit A (right)
 - › PUR cable
 - › Cable length 25 m
 - › With flying lead
 - › Cores color-coded
-



092912 C-M23F19-19XDIFPU25,0-MA-092912

▼ Features

- › M23 plug connector, 18-pin + PE
 - › Angled plug connector
 - › Cable exit C (left)
 - › PUR cable
 - › Cable length 25 m
 - › With flying lead
 - › Cores color-coded
-

▼ Connection cable with plug connector M23 with option C1825, 15m, angled



085196 C-M23F19-19XDIFPU15,0-MA-085196

▼ Features

- › M23 plug connector, 18-pin + PE
 - › Angled plug connector
 - › Cable exit A (right)
 - › PUR cable
 - › Cable length 15 m
 - › With flying lead
 - › Cores color-coded
-



077020 C-M23F19-19XDIFPU15,0-MA-077020

▼ Features

- › M23 plug connector, 18-pin + PE
 - › Angled plug connector
 - › Cable exit C (left)
 - › PUR cable
 - › Cable length 15 m
 - › With flying lead
 - › Cores color-coded
-

▼ Connection cable with plug connector M23 with option C1825, 20m, angled

092911 C-M23F19-19XDIFPU20,0-MA-092911



- ▼ Features
 - › M23 plug connector, 18-pin + PE
 - › Angled plug connector
 - › Cable exit A (right)
 - › PUR cable
 - › Cable length 20 m
 - › With flying lead
 - › Cores color-coded
-



092910 C-M23F19-19XDIFPU20,0-MA-092910

- ▼ Features
 - › M23 plug connector, 18-pin + PE
 - › Angled plug connector
 - › Cable exit C (left)
 - › PUR cable
 - › Cable length 20 m
 - › With flying lead
 - › Cores color-coded
-

- ▼ Connection cable with plug connector M23 with option C1825, 1.5m, angled



092906 C-M23F19-19XDIFPU01,5-MA-092906

- ▼ Features
 - › M23 plug connector, 18-pin + PE
 - › Angled plug connector
 - › Cable exit C (left)
 - › PUR cable
 - › Cable length 1.5 m
 - › With flying lead
 - › Cores color-coded
-



092907 C-M23F19-19XDIFPU01,5-MA-092907

- ▼ Features
 - › M23 plug connector, 18-pin + PE
 - › Angled plug connector
 - › Cable exit A (right)
 - › PUR cable
 - › Cable length 1.5 m
 - › With flying lead
 - › Cores color-coded
-

- ▼ Connection cable with plug connector M23 with option C1825, 6m, angled



077018 C-M23F19-19XDIFPU06,0-MA-077018

- ▼ Features
 - › M23 plug connector, 18-pin + PE
 - › Angled plug connector
 - › Cable exit C (left)
 - › PUR cable
 - › Cable length 6 m
 - › With flying lead
 - › Cores color-coded
-



085194 C-M23F19-19XDIFPU06,0-MA-085194

▼ Features

- › M23 plug connector, 18-pin + PE
 - › Angled plug connector
 - › Cable exit A (right)
 - › PUR cable
 - › Cable length 6 m
 - › With flying lead
 - › Cores color-coded
-

▼ Connection cable with plug connector M23 with option C1825, 3m, angled



092908 C-M23F19-19XDIFPU03,0-MA-092908

▼ Features

- › M23 plug connector, 18-pin + PE
 - › Angled plug connector
 - › Cable exit C (left)
 - › PUR cable
 - › Cable length 3 m
 - › With flying lead
 - › Cores color-coded
-



092909 C-M23F19-19XDIFPU03,0-MA-092909

▼ Features

- › M23 plug connector, 18-pin + PE
 - › Angled plug connector
 - › Cable exit A (right)
 - › PUR cable
 - › Cable length 3 m
 - › With flying lead
 - › Cores color-coded
-

▼ Female connector RC18 angled with option C1825



077026 RC18WF-C1825

▼ Features

- › Plug connector M23, angled
 - › Number of pins: 19-pin with screen bonding clamp
-

▼ Female plug RC18 straight with option C1825



077025 RC18EF-C1825

▼ Features

- › Plug connector M23, straight
 - › Number of pins: 19-pin with screen bonding clamp
-

▼ Replacement crimp contacts for female connector RC18

094309 CRIMPKONTAKT BUCHSE RCF

▼ Features

- › 19 crimp sockets
- › Conductor cross-section 19 x 0.75 - 1 mm²

- › For plug connector RC18
-

▼ Female plug RC18 angled



074617 RC18WF

▼ Features

- › Plug connector M23, angled
 - › Number of pins: 19-pin with screen bonding clamp
-

▼ Female plug RC18 straight



074616 RC18EF

▼ Features

- › Plug connector M23, straight
 - › Number of pins: 19-pin with screen bonding clamp
-

▼ Replacement crimp contacts for female connector RC18 with option C1825

094310 CRIMPKONTAKT BUCHSE RCF-C1825

▼ Features

- › 19 crimp sockets
 - › Conductor cross-section 16 x 0.25 - 0.5 mm² and 3 x 0.75 - 1 mm²
 - › For plug connector RC18..C1825
-

▼ Connection cable with plug connector M23 with option C1825, 1.5m, straight



092761 C-M23F19-19XDIFPU01,5-MA-092761

▼ Features

- › M23 plug connector, 18-pin + PE
 - › Straight plug connector
 - › PUR cable
 - › Cable length 1.5 m
 - › With flying lead
 - › Cores color-coded
-

▼ Connection cable with plug connector M23 with option C1825, 3m, straight



092816 C-M23F19-19XDIFPU03,0-MA-092816

▼ Features

- › M23 plug connector, 18-pin + PE
 - › Straight plug connector
 - › PUR cable
 - › Cable length 3 m
 - › With flying lead
 - › Cores color-coded
-

▼ Connection cable with plug connector M23 with option C1825, 6m, straight



077014 C-M23F19-19XDIFPU06,0-MA-077014

▼ Features

- › M23 plug connector, 18-pin + PE
 - › Straight plug connector
 - › PUR cable
 - › Cable length 6 m
 - › With flying lead
 - › Cores color-coded
-

▼ Connection cable with plug connector M23 with option C1825, 8m, straight



077015 C-M23F19-19XDIFPU08,0-MA-077015

▼ Features

- › M23 plug connector, 18-pin + PE
 - › Straight plug connector
 - › PUR cable
 - › Cable length 8 m
 - › With flying lead
 - › Cores color-coded
-

▼ Connection cable with plug connector M23 with option C1825, 10m, straight



092898 C-M23F19-19XDIFPU10,0-MA-092898

▼ Features

- › M23 plug connector, 18-pin + PE
 - › Straight plug connector
 - › PUR cable
 - › Cable length 10 m
 - › With flying lead
 - › Cores color-coded
-

▼ Connection cable with plug connector M23 with option C1825, 15m, straight



077016 C-M23F19-19XDIFPU15,0-MA-077016

▼ Features

- › M23 plug connector, 18-pin + PE
 - › Straight plug connector
 - › PUR cable
 - › Cable length 15 m
 - › With flying lead
 - › Cores color-coded
-

▼ Connection cable with plug connector M23 with option C1825, 25m, straight



092727 C-M23F19-19XDIFPU25,0-MA-092727

▼ Features

- › M23 plug connector, 18-pin + PE
 - › Straight plug connector
 - › PUR cable
 - › Cable length 25 m
 - › With flying lead
 - › Cores color-coded
-

▼ Connection cable with plug connector M23 with option C1825, 20m, straight



092726 C-M23F19-19XDIFPU20,0-MA-092726

▼ Features

- › M23 plug connector, 18-pin + PE
 - › Straight plug connector
 - › PUR cable
 - › Cable length 20 m
 - › With flying lead
 - › Cores color-coded
-

▼ Connection cable with plug connector M23 with option C1825, 40m, straight



102490 C-M23F19-19XDIFPU40,0-MA-102490

▼ Features

- › M23 plug connector, 18-pin + PE
 - › Straight plug connector
 - › PUR cable
 - › Cable length 40 m
 - › With flying lead
 - › Cores color-coded
-

▼ Connection cable with plug connector M23 with option C1825, 30m, straight



095993 C-M23F19-19XDIFPU30,0-MA-095993

▼ Features

- › M23 plug connector, 18-pin + PE
 - › Straight plug connector
 - › PUR cable
 - › Cable length 30 m
 - › With flying lead
 - › Cores color-coded
-

Bolt

▼ Bolts with escape release for safety switch CTP



123655 RIEGEL CTP-ACF-123655

▼ Features

- › Steel bolt
 - › Lever for escape release from the danger area
 - › For doors hinged on right and left
 - › Detent knob in open position
 - › Can be locked in open position with padlocks
 - › Actuator included
-

▼ Bolt BTC-CTP with escape release for safety switch CTP



123660 BTC-CTP-S-TH-01-F

▼ Features

- › Aluminum bolt
- › For doors hinged on the left or right
- › Lever for escape release from the danger area
- › Pushbutton in open position

- › Can be locked in open position with padlocks
- › Actuator included

▼ Bolt CTP-GFK-F with escape release for safety switch CTP



123658 RIEGEL CTP-GFK-F

▼ Features

- › Fiber glass reinforced plastic bolt
- › For doors hinged on the left or right
- › Lever for escape release from the danger area
- › Detent knob in open position
- › Can be locked in open position with padlocks
- › Actuator included

Instructions

▼ Bezpečnostní informace CTP (-AR/-AP)

	Doc. no.	Version	Language	Download
Sicherheitsinformation CTP (-AR/-AP)	2138087	02-11/17		0.7 MB
Información de seguridad CTP (-AR/-AP)				
Information de sécurité CTP (-AR/-AP)				
Informazioni sulla sicurezza CTP (-AR/-AP)				
Safety Information CTP (-AR/-AP)				
Bezpečnostní informace CTP (-AR/-AP)	2138087	02-11/17		0.2 MB
安全情報 CTP (-AR/-AP)	2138087	02-11/17		0.3 MB
Informação de segurança CTP (-AR/-AP)	2138087	02-11/17		0.2 MB
Информация о безопасности CTP (-AR/-AP)	2138087	02-11/17		0.3 MB
Güvenlik bilgisi CTP (-AR/-AP)	2138087	02-11/17		0.3 MB
安全信息 CTP (-AR/-AP)	2138087	02-11/17		0.3 MB

▼ 操作指示書トランスポンダー型コード化安全スイッチ ガードロック内蔵CTP-AP ユニコード/マルチコード

	Doc. no.	Version	Language	Download
Betriebsanleitung Transpondercodierter Sicherheitsschalter mit Zuhaltung CTP-AP Uni-/Multicode	2124217	05-05/18		4.2 MB
Mode d'emploi Interrupteur de sécurité à codage par transpondeur avec interverrouillage CTP-AP uni-/multicode	2124217	05-05/18		4.2 MB
Manual de instrucciones Interruptor de seguridad con codificación por transponder con bloqueo CTP-AP Unicode/Multicode	2124217	05-05/18		4.2 MB
操作指示書トランスポンダー型コード化安全スイッチ ガードロック内蔵CTP-AP ユニコード/マルチコード	2124217	05-05/18		4.5 MB
Návod k použití Bezpečnostní spínač s kódovaným transpondérem CTP-AP Unicode/Multicode	2124217	05-05/18		4.4 MB

Operating instructions Transponder-Coded Safety Switch With Guard Locking CTP-AP Unicode/Multicode	2124217	05-05/18		 4.2 MB
Istruzioni di impiego Finecorsa di sicurezza con codifica a transponder con meccanismo di ritenuta CTP-AP Uni-/Multicode	2124217	05-05/18		 4.2 MB

Catalogs



ガード・ロック付き トランスポンダー・コード化 安全スイッチCTP





	Doc. no.	Version	Language	Download
ガード・ロック付き トランスポンダー・コード化 安全スイッチCTP	136411	09-03/16		 1.8 MB

Transpondercodierter Sicherheitsschalter CTP mit Zuhaltung transponder-coded safety switch CTP with guard locking Interrupteur de sécurité à codage par transpondeur CTP avec interverrouillage Interruptor de seguridad CTP codifi cado por transponder con bloqueo Finecorsa di sicurezza con codifi ca a transponder CTP con meccanismo di ritenuta Kilitli RFID kodlu emniyet salteri CTP Chave de segurança codifi cada por transponder CTP com bloqueio Bezpečnostní spínac CTP s kódovaným transpondérem a jištením ochranného krytu 帶鎖定功能的 CTP应答式編碼 安全开关

	Doc. no.	Version	Language	Download
Transpondercodierter Sicherheitsschalter CTP mit Zuhaltung	123243	12-02/18		 2.3 MB
Interrupteur de sécurité à codage par transpondeur CTP avec interverrouillage	123245	12-02/18		 2.3 MB
Interruptor de seguridad CTP codifi cado por transponder con bloqueo	123246	12-02/18		 2.3 MB
transponder-coded safety switch CTP with guard locking	123244	12-02/18		 2.3 MB
Finecorsa di sicurezza con codifi ca a transponder CTP con meccanismo di ritenuta	126042	12-02/18		 2.3 MB
Kilitli RFID kodlu emniyet salteri CTP	126076	12-02/18		 2.4 MB
Chave de segurança codifi cada por transponder CTP com bloqueio	126214	12-02/18		 2.3 MB
Bezpečnostní spínac CTP s kódovaným transpondérem a jištením ochranného krytu	126604	12-02/18		 2.3 MB
帶鎖定功能的 CTP应答式編碼 安全开关	158439	12-02/18		 2.4 MB







Transpondercodierte Sicherheitsschalter - Verriegelungseinrichtungen und Zuhaltungen Transponder-coded safety switches - Interlocking devices and guard locking devices Interruptores de seguridad con codificación por transponder - Dispositivos de enclavamiento y bloqueos Interrupteurs de sécurité à codage par transpondeur - Dispositifs de verrouillage et interverrouillages

	Doc. no.	Version	Language	Download
Transpondercodierte Sicherheitsschalter - Verriegelungseinrichtungen und Zuhaltungen	127594	02-01/18		 5.2 MB
Interrupteurs de sécurité à codage par transpondeur - Dispositifs de verrouillage et interverrouillages	137558	02-01/18		 5.2 MB

Interrupidores de seguridad con codificación por transponder - Dispositivos de enclavamiento y bloqueos	137560	02-01/18		 5.2 MB
Transponder-coded safety switches - Interlocking devices and guard locking devices	127595	02-01/18		 5.1 MB

Declaration of conformity

EU-Konformitätserklärung

	Doc. no.	Version	Language	Download
EU-Konformitätserklärung	2123042	06-08/18		 0.4 MB
EU declaration of conformity				
Declaración UE de conformidad				
Déclaration UE de conformité				
Dichiarazione di conformità				

CAD data

CAD data for this item on TraceParts