

ITEM 123370 CTP-L2-AP-U-HA-AZ-SH-123370

Description	Technical data	Accessories	Downloads
-------------	----------------	-------------	-----------



Features

- › Safety switch with guard locking and integrated evaluation electronics
- › Short circuit monitoring
- › 2 safety outputs (semiconductor outputs)
- › Up to category 4/PL e according to EN ISO 13849-1
- › With plug connector M23
- › Unicode
- › Door monitoring output
- › Approach direction A, B and C (default setting on delivery)

Approach direction

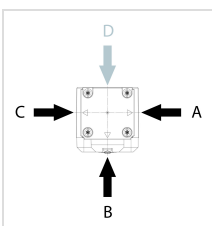

- › Figure
Horizontal
Can be adjusted in 90° steps

Unicode evaluation

Each actuator is unique. The switch detects only taught-in actuators. Additional actuators can be taught in. Only the last actuator taught in is detected.

Guard locking type

CTP-L2 Guard locking actuated by power-ON applied and spring released (open-circuit current principle).

Connector assignment

Plug connector (view of connection side)	Pin	Designation	Function	Conductor coloring of connection cable
	1	IMP	Operating voltage of guard locking solenoid, 24 V DC	VT
	2	-	n.c.	RD
	3	-	n.c.	GY
	4	FO1A	Safety output, channel 1 	RD/BU
	5	FO1B	Safety output, channel 2 	GN
	6	UB	Operating voltage of AP electronics, 24 V DC	BU
	7	RST	Reset input	GY/PK
	8	OD	Door monitoring output	GN/WH
	9	OI	Diagnostics output	YE/WH
	10	OL	Guard locking monitoring output	GY/WH
	11	-	n.c.	BK
	12	FE	Function earth (must be connected to meet the EMC requirements)	GN/YE
	13	-	n.c.	PK
	14	-	n.c.	BN/GY
	15	-	n.c.	BN/YE
	16	-	n.c.	BN/GN
	17	-	n.c.	WH
	18	IMM	Operating voltage of guard locking solenoid 0 V	YE

Plug connector (view of connection side)	Pin	Designation	Function	Conductor coloring of connection cable
	19	0 V UB	Operating voltage of AP electronics, 0 V	BN

Approvals



Mechanical values and environment

Housing material		
Switch head cover		Die-cast zinc
Safety switch housing		Fiber glass reinforced thermoplastic
Weight		
	Net	0,42 kg
Ambient temperature		
	At $U_B = 24V DC$	-20 ... +55 °C
Degree of protection		IP67 [1]
Resilience to vibration		In acc. with EN IEC 60947-5-3
Mechanical life		1×10^6
Installation position		Any
Ready delay		max.1 s
Switching frequency		max.0,5 Hz
Connection		1 plug connector M23, 19-pin, RC18
Approach speed		20 m/min
Guard locking principle		Open-circuit current principle
Locking force F_{max}		3900 N
Locking force F_{Zh}		3000 N [2]
Retention force		20 N
Extraction force		20 N
Actuating force		10 N
Overtravel		5 mm

Electrical connection ratings

Test-pulse interval		min.100 ms
Test pulses		max.0,3 ms [3]
Operating voltage DC		
	U_{UB}	24 V DC -15% ... 15% Reverse polarity protected, regulated, residual ripple < 5%, PELV
Current consumption		

	I_{UB}	40 mA
	I_{IMP}	400 mA
Utilization category according to EN 60947-5-2		
	DC-13	24V 150mA ^[4]
Solenoid operating voltage DC		
	U_{IMP}	24 V DC -15% ... +10% Reverse polarity protected, regulated, residual ripple < 5%, PELV
Fusing		
External (operating voltage U_B)		0,25 ... 2 A
External (solenoid operating voltage U_{IMP})		0,5 ... 8 A
Rated insulation voltage U_i		max.50 V
Rated impulse withstand voltage U_{imp}		max.0,5 kV
Power consumption		6 W
EMC protection requirements		In acc. with EN IEC 60947-5-3
Solenoid duty cycle		100 %
Degree of contamination (external, according to EN 60947-1)		3
Safety class		
	EN IEC 61140	III
Switching load		
	According to UL	24V DC, class 2 ^[5]
		Safety outputs FO1A / FO1B
Type of output		2 semiconductor outputs, p-switching, short circuit-proof
Switching current		
Per safety output FO1A / FO1B		1 ... 150 mA
Output voltage		
High $U(FO1A) / U(FO1B)$		$U_B - 1,5 \dots U_B$ V DC
Low $U(FO1A) / U(FO1B)$		0 ... 1 V DC
Off-state current I_r		max.0,25 mA
Switch-on time		max.400 ms
Discrepancy time		
Both safety outputs		In acc. with EN IEC 60947-5-3 max.10 ms
		Monitoring output OL
Type of output		p-switching, short circuit-proof
Switching current		1 ... 50 mA
Output voltage		$0,8 \times U_B \dots U_B$ V DC
		Monitoring output OD
Type of output		p-switching, short circuit-proof
Switching current		1 ... 50 mA
Output voltage		$0,8 \times U_B \dots U_B$ V DC
		Monitoring output OI
Type of output		p-switching, short circuit-proof
Switching current		1 ... 50 mA
Output voltage		$0,8 \times U_B \dots U_B$ V DC

Operating distance

Repeat accuracy R	
According to EN 60947-5-2	10 %

Miscellaneous

For the approval according to UL the following applies	Operation only with UL class 2 power supply, or equivalent measures see operating instructions
--	--

Reliability values acc. to EN ISO 13849-1

Performance Level	PL e
Category	4
PFH _D	4.1×10^{-9}
Mission time	20 y

[1] Screwed tight plug connector/mating component

[2] $F_{zh} = F_{max}/1.3$ Depending on the actuator used

[3] Applies for a load with $C \leq 30nF$ and $R \leq 20k\Omega$

[4] Caution: outputs must be protected with a free-wheeling diode in case of inductive loads

[5] Alternatively see operating instructions

Dimension drawing

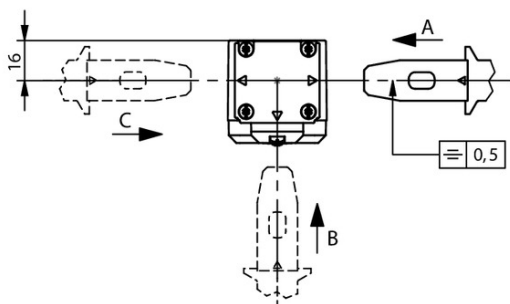
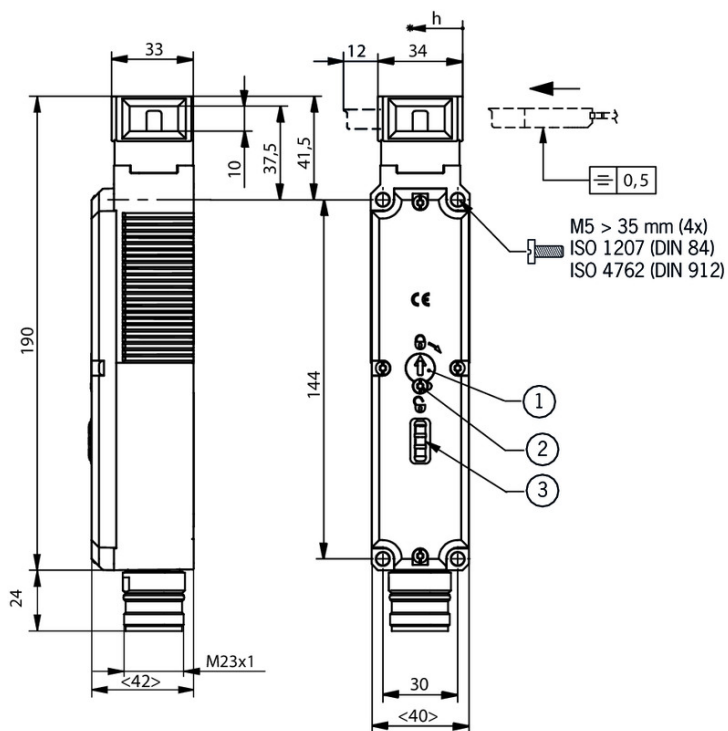

Wiring diagram

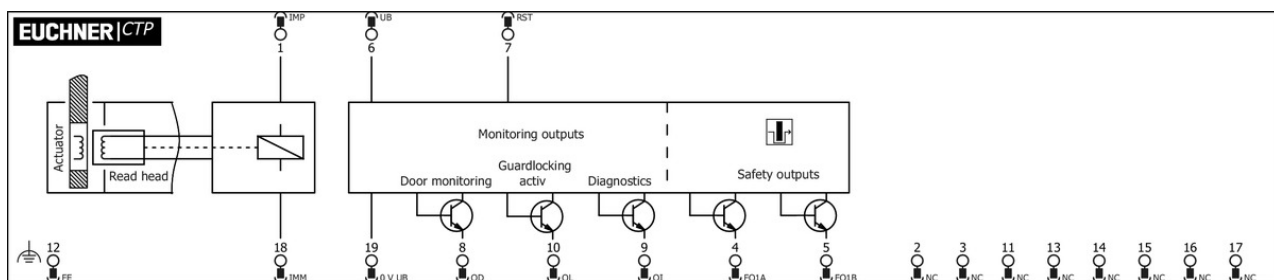

Actuator

▼ Bent actuator for safety switches CTP



122667 A-C-H-W-SST-122667

▼ Features

- › Actuator bent at top
- › Two safety screws included



122668 A-C-H-W-SST-122668

✓ Features

- › Actuator bent at bottom
 - › Two safety screws included
-

✓ Hinged actuator for safety switch CTP



122675 A-C-H-RO-LS-122675

✓ Features

- › Hinged actuator for doors hinged at the top
 - › Two safety screws included
-



122672 A-C-H-RR-LS-122672

✓ Features

- › Hinged actuator for doors hinged on the right
 - › Two safety screws included
-



122676 A-C-H-RU-LS-122676

✓ Features

- › Hinged actuator for doors hinged at the bottom
 - › Two safety screws included
-



122671 A-C-H-RL-LS-122671

✓ Features

- › Hinged actuator for doors hinged on the left
 - › Two safety screws included
-

✓ Straight actuator for safety switch CTP



126015 A-C-H-G-SST-126015

✓ Features

- › Straight actuator
 - › Two safety screws included
-

Function expansion

✓ Lockout mechanism CTP



123411 AE-L-C-H-123411

✓ Features

- › Prevents unintentional closing of the door
 - › Can be secured with padlocks
-

✓ Lock for auxiliary release for safety switches CTP/TP/STP



109212 SCHLOSS TP GLEICHSCHLIESSEND C2293

✓ Features

- › Identical locking

- › Key can be removed only in “locked” position



084177 SCHLOSS TP VERSCHIEDENSCHLIESSEND

▣ Features

- › Lock unique locking
- › Key removable in “unlocked” and “locked” positions



086236 SCHLOSS TP GLEICHSCHLIESSEND

▣ Features

- › Identical locking
- › Key removable in “unlocked” and “locked” positions

▣ Emergency unlocking for safety switches CTP/TP/STP



099877 NOTENTSPERRUNG TP/STP

▣ Release with automatic reset for safety switches CTP/TP/STP



103110 ENTRIEGELUNG RUECKSTELLEND TP/STP

▣ Handle for wire front release



099795 AY-HDL-099795

▣ Features

- › Suitable for all wire front releases



124204 AY-HDL-124204

▣ Features

- › Suitable for all wire front releases

▣ Wire front release



124770 AE-B-A1-06,0-F-124770

▣ Features

- › Can be used as escape release or emergency unlocking
- › automatic return
- › Rope length 6 m (without sheath)



125582 AE-B-A1-06,0-125582

▣ Features

- › Can be used as escape release or emergency unlocking
- › No automatic return
- › Rope length 6 m (without sheath)



097747 AE-B-A1-02,0-F-097747

▣ Features

- › Can be used as escape release or emergency unlocking
- › automatic return
- › Sheath length 2 m (rope length 6 m)



098313 AE-B-A1-03,0-098313

✓ Features

- › Can be used as escape release or emergency unlocking
- › No automatic return
- › Sheath length 3 m (rope length 6 m)



111233 AE-B-A1-03,0-F-111233

✓ Features

- › Can be used as escape release or emergency unlocking
- › automatic return
- › Sheath length 3 m (rope length 6 m)



098314 AE-B-A1-04,0-098314

✓ Features

- › Can be used as escape release or emergency unlocking
- › No automatic return
- › Sheath length 4 m (rope length 6 m)



096230 AE-B-A1-02,0-096230

✓ Features

- › Can be used as escape release or emergency unlocking
- › No automatic return
- › Sheath length 2 m (rope length 6 m)

Mounting accessories

- ✓ Mounting plates EMP-SB for safety switches CTP, TP...A, STA, STP and TX



093456 EMP-SB

✓ Features

- › For vertical and horizontal mounting of safety switches TP...A, STA, STP and TX

- ✓ Mounting plates EMP-B2 for actuators for safety switches CTP, TP...A, STA, STP, TX and TZ



093458 EMP-B2

- ✓ Mounting plates EMP-B1 for actuators for safety switches CTP, TP...A, STA, STP, TX and TZ



093457 EMP-B1

- ✓ Mounting plates AM-P for safety switches CTP



126026 AM-P-126026

Features

- › For vertical and horizontal mounting of safety switch CTP

Connection material

- Connection cable with plug connector M23 with option C1825, 1.5m, straight



092761 C-M23F19-19XDIFPU01,5-MA-092761

Features

- › M23 plug connector, 18-pin + PE
- › Straight plug connector
- › PUR cable
- › Cable length 1.5 m
- › With flying lead
- › Cores color-coded

- Connection cable with plug connector M23 with option C1825, 6m, angled



085194 C-M23F19-19XDIFPU06,0-MA-085194

Features

- › M23 plug connector, 18-pin + PE
- › Angled plug connector
- › Cable exit A (right)
- › PUR cable
- › Cable length 6 m
- › With flying lead
- › Cores color-coded



077018 C-M23F19-19XDIFPU06,0-MA-077018

Features

- › M23 plug connector, 18-pin + PE
- › Angled plug connector
- › Cable exit C (left)
- › PUR cable
- › Cable length 6 m
- › With flying lead
- › Cores color-coded

- Connection cable with plug connector M23 with option C1825, 8m, angled



085195 C-M23F19-19XDIFPU08,0-MA-085195

Features

- › M23 plug connector, 18-pin + PE
- › Angled plug connector
- › Cable exit A (right)
- › PUR cable
- › Cable length 8 m
- › With flying lead
- › Cores color-coded



077019 C-M23F19-19XDIFPU08,0-MA-077019

▼ Features

- › RC18 plug connector, 18-pin + PE
 - › Angled plug connector
 - › Cable exit C (left)
 - › PUR cable
 - › Cable length 8 m
 - › With flying lead
 - › Cores color-coded
-

▼ Connection cable with plug connector M23 with option C1825, 10m, angled



092902 C-M23F19-19XDIFPU10,0-MA-092902

▼ Features

- › M23 plug connector, 18-pin + PE
 - › Angled plug connector
 - › Cable exit A (right)
 - › PUR cable
 - › Cable length 10 m
 - › With flying lead
 - › Cores color-coded
-



092901 C-M23F19-19XDIFPU10,0-MA-092901

▼ Features

- › M23 plug connector, 18-pin + PE
 - › Angled plug connector
 - › Cable exit C (left)
 - › PUR cable
 - › Cable length 10 m
 - › With flying lead
 - › Cores color-coded
-

▼ Connection cable with plug connector M23 with option C1825, 1.5m, angled



092907 C-M23F19-19XDIFPU01,5-MA-092907

▼ Features

- › M23 plug connector, 18-pin + PE
 - › Angled plug connector
 - › Cable exit A (right)
 - › PUR cable
 - › Cable length 1.5 m
 - › With flying lead
 - › Cores color-coded
-



092906 C-M23F19-19XDIFPU01,5-MA-092906

▼ Features

- › M23 plug connector, 18-pin + PE
- › Angled plug connector
- › Cable exit C (left)
- › PUR cable
- › Cable length 1.5 m
- › With flying lead
- › Cores color-coded

-
- ▼ Connection cable with plug connector M23 with option C1825, 40m, straight



102490 C-M23F19-19XDIFPU40,0-MA-102490

▼ Features

- › M23 plug connector, 18-pin + PE
 - › Straight plug connector
 - › PUR cable
 - › Cable length 40 m
 - › With flying lead
 - › Cores color-coded
-

- ▼ Connection cable with plug connector M23 with option C1825, 30m, straight



095993 C-M23F19-19XDIFPU30,0-MA-095993

▼ Features

- › M23 plug connector, 18-pin + PE
 - › Straight plug connector
 - › PUR cable
 - › Cable length 30 m
 - › With flying lead
 - › Cores color-coded
-

- ▼ Connection cable with plug connector M23 with option C1825, 25m, straight



092727 C-M23F19-19XDIFPU25,0-MA-092727

▼ Features

- › M23 plug connector, 18-pin + PE
 - › Straight plug connector
 - › PUR cable
 - › Cable length 25 m
 - › With flying lead
 - › Cores color-coded
-

- ▼ Connection cable with plug connector M23 with option C1825, 15m, straight



077016 C-M23F19-19XDIFPU15,0-MA-077016

▼ Features

- › M23 plug connector, 18-pin + PE
 - › Straight plug connector
 - › PUR cable
 - › Cable length 15 m
 - › With flying lead
 - › Cores color-coded
-

- ▼ Connection cable with plug connector M23 with option C1825, 20m, straight



092726 C-M23F19-19XDIFPU20,0-MA-092726

▼ Features

- › M23 plug connector, 18-pin + PE
- › Straight plug connector
- › PUR cable
- › Cable length 20 m

- › With flying lead
 - › Cores color-coded
-

▼ Connection cable with plug connector M23 with option C1825, 8m, straight



077015 C-M23F19-19XDIFPU08,0-MA-077015

▼ Features

- › M23 plug connector, 18-pin + PE
 - › Straight plug connector
 - › PUR cable
 - › Cable length 8 m
 - › With flying lead
 - › Cores color-coded
-

▼ Connection cable with plug connector M23 with option C1825, 10m, straight



092898 C-M23F19-19XDIFPU10,0-MA-092898

▼ Features

- › M23 plug connector, 18-pin + PE
 - › Straight plug connector
 - › PUR cable
 - › Cable length 10 m
 - › With flying lead
 - › Cores color-coded
-

▼ Connection cable with plug connector M23 with option C1825, 3m, straight



092816 C-M23F19-19XDIFPU03,0-MA-092816

▼ Features

- › M23 plug connector, 18-pin + PE
 - › Straight plug connector
 - › PUR cable
 - › Cable length 3 m
 - › With flying lead
 - › Cores color-coded
-

▼ Connection cable with plug connector M23 with option C1825, 6m, straight



077014 C-M23F19-19XDIFPU06,0-MA-077014

▼ Features

- › M23 plug connector, 18-pin + PE
 - › Straight plug connector
 - › PUR cable
 - › Cable length 6 m
 - › With flying lead
 - › Cores color-coded
-

▼ Connection cable with plug connector M23 with option C1825, 3m, angled



092909 C-M23F19-19XDIFPU03,0-MA-092909

▼ Features

- › M23 plug connector, 18-pin + PE

- › Angled plug connector
- › Cable exit A (right)
- › PUR cable
- › Cable length 3 m
- › With flying lead
- › Cores color-coded



092908 C-M23F19-19XDIFPU03,0-MA-092908

▣ Features

- › M23 plug connector, 18-pin + PE
- › Angled plug connector
- › Cable exit C (left)
- › PUR cable
- › Cable length 3 m
- › With flying lead
- › Cores color-coded

▣ Connection cable with plug connector M23 with option C1825, 15m, angled



085196 C-M23F19-19XDIFPU15,0-MA-085196

▣ Features

- › M23 plug connector, 18-pin + PE
- › Angled plug connector
- › Cable exit A (right)
- › PUR cable
- › Cable length 15 m
- › With flying lead
- › Cores color-coded



077020 C-M23F19-19XDIFPU15,0-MA-077020

▣ Features

- › M23 plug connector, 18-pin + PE
- › Angled plug connector
- › Cable exit C (left)
- › PUR cable
- › Cable length 15 m
- › With flying lead
- › Cores color-coded

▣ Connection cable with plug connector M23 with option C1825, 25m, angled



092913 C-M23F19-19XDIFPU25,0-MA-092913

▣ Features

- › M23 plug connector, 18-pin + PE
- › Angled plug connector
- › Cable exit A (right)
- › PUR cable
- › Cable length 25 m
- › With flying lead
- › Cores color-coded



092912 C-M23F19-19XDIFPU25,0-MA-092912

▣ Features

- › M23 plug connector, 18-pin + PE
 - › Angled plug connector
 - › Cable exit C (left)
 - › PUR cable
 - › Cable length 25 m
 - › With flying lead
 - › Cores color-coded
-

▼ Connection cable with plug connector M23 with option C1825, 20m, angled



092911 C-M23F19-19XDIFPU20,0-MA-092911

▼ Features

- › M23 plug connector, 18-pin + PE
 - › Angled plug connector
 - › Cable exit A (right)
 - › PUR cable
 - › Cable length 20 m
 - › With flying lead
 - › Cores color-coded
-



092910 C-M23F19-19XDIFPU20,0-MA-092910

▼ Features

- › M23 plug connector, 18-pin + PE
 - › Angled plug connector
 - › Cable exit C (left)
 - › PUR cable
 - › Cable length 20 m
 - › With flying lead
 - › Cores color-coded
-

▼ Female plug RC18 straight



074616 RC18EF

▼ Features

- › Plug connector M23, straight
 - › Number of pins: 19-pin with screen bonding clamp
-

▼ Female plug RC18 angled



074617 RC18WF

▼ Features

- › Plug connector M23, angled
 - › Number of pins: 19-pin with screen bonding clamp
-

▼ Replacement crimp contacts for female connector RC18

094309 CRIMPKONTAKT BUCHSE RCF

▼ Features

- › 19 crimp sockets
 - › Conductor cross-section 19 x 0.75 - 1 mm²
 - › For plug connector RC18
-

▼ Female plug RC18 straight with option C1825



077025 RC18EF-C1825

▼ Features

- › Plug connector M23, straight
 - › Number of pins: 19-pin with screen bonding clamp
-

▼ Female connector RC18 angled with option C1825



077026 RC18WF-C1825

▼ Features

- › Plug connector M23, angled
 - › Number of pins: 19-pin with screen bonding clamp
-

▼ Replacement crimp contacts for female connector RC18 with option C1825

094310 CRIMPKONTAKT BUCHSE RCF-C1825

▼ Features

- › 19 crimp sockets
 - › Conductor cross-section 16 x 0.25 - 0.5 mm² and 3 x 0.75 - 1 mm²
 - › For plug connector RC18..C1825
-

Bolt

▼ Bolts for safety switches series CTP



123653 RIEGEL CTP-AC-123653

▼ Features

- › Steel bolt
 - › For doors hinged on right and left
 - › Can be locked in open position with padlocks
 - › Actuator included
-

▼ Bolt BTC-CTP-S for safety switch CTP



123659 BTC-CTP-S-TH-00-X

▼ Features

- › Aluminum bolt
 - › For doors hinged on the left or right
 - › Can be locked in open position with padlocks
 - › Actuator included
-

▼ Bolt CTP-GFK for safety switch CTP



123657 RIEGEL CTP-GFK

▼ Features

- › Fiber glass reinforced plastic bolt
- › For doors hinged on the left or right
- › Can be locked in open position with padlocks
- › Actuator included

Instructions

Bezpečnostní informace CTP (-AR/-AP)

	Doc. no.	Version	Language	Download
Sicherheitsinformation CTP (-AR/-AP)	2138087	02-11/17		0.7 MB
Información de seguridad CTP (-AR/-AP)				
Information de sécurité CTP (-AR/-AP)				
Informazioni sulla sicurezza CTP (-AR/-AP)				
Safety Information CTP (-AR/-AP)				
Bezpečnostní informace CTP (-AR/-AP)	2138087	02-11/17		0.2 MB
安全情報 CTP (-AR/-AP)	2138087	02-11/17		0.3 MB
Informação de segurança CTP (-AR/-AP)	2138087	02-11/17		0.2 MB
Информация о безопасности CTP (-AR/-AP)	2138087	02-11/17		0.3 MB
Güvenlik bilgisi CTP (-AR/-AP)	2138087	02-11/17		0.3 MB
安全信息 CTP (-AR/-AP)	2138087	02-11/17		0.3 MB



操作指示書トランスポンダー型コード化安全スイッチ ガードロック内蔵CTP-AP ユニコード/マルチコード

	Doc. no.	Version	Language	Download
Betriebsanleitung Transpondercodierter Sicherheitsschalter mit Zuhaltung CTP-AP Uni-/Multicode	2124217	05-05/18		4.2 MB
Mode d'emploi Interrupteur de sécurité à codage par transpondeur avec interverrouillage CTP-AP uni-/multicode	2124217	05-05/18		4.2 MB
Manual de instrucciones Interruptor de seguridad con codificación por transponder con bloqueo CTP-AP Unicode/Multicode	2124217	05-05/18		4.2 MB
操作指示書トランスポンダー型コード化安全スイッチ ガードロック内蔵CTP-AP ユニコード/マルチコード	2124217	05-05/18		4.5 MB
Návod k použití Bezpečnostní spínač s kódovaným transpondérem CTP-AP Unicode/Multicode	2124217	05-05/18		4.4 MB
Operating instructions Transponder-Coded Safety Switch With Guard Locking CTP-AP Unicode/Multicode	2124217	05-05/18		4.2 MB
Istruzioni di impiego Finecorsa di sicurezza con codifica a transponder con meccanismo di ritenuta CTP-AP Uni-/Multicode	2124217	05-05/18		4.2 MB

Catalogs

ガード・ロック付き トランスポンダー・コード化 安全スイッチCTP





Doc. no.	Version	Language	Download
----------	---------	----------	----------

ガード・ロック付き トランスポンダー・コード化 安全スイッチCTP 136411 09-03/16   1.8 MB

- Transpondercodierter Sicherheitsschalter CTP mit Zuhaltung transponder-coded safety switch CTP with guard locking Interrupteur de sécurité à codage par transpondeur CTP avec interverrouillage Interruptor de seguridad CTP codifi cado por transponder con bloqueo Finecorsa di sicurezza con codifi ca a transponder CTP con meccanismo di ritenuta Kilitli RFID kodlu emniyet salteri CTP Chave de segurança codifi cada por transponder CTP com bloqueio Bezpečnostní spínac CTP s kódovaným transpondérem a jištením ochranného krytu 带锁定功能的 CTP应答式编码 安全开关

	Doc. no.	Version	Language	Download
Transpondercodierter Sicherheitsschalter CTP mit Zuhaltung	123243	12-02/18		 2.3 MB
Interrupteur de sécurité à codage par transpondeur CTP avec interverrouillage	123245	12-02/18		 2.3 MB
Interruptor de seguridad CTP codifi cado por transponder con bloqueo	123246	12-02/18		 2.3 MB
transponder-coded safety switch CTP with guard locking	123244	12-02/18		 2.3 MB
Finecorsa di sicurezza con codifi ca a transponder CTP con meccanismo di ritenuta	126042	12-02/18		 2.3 MB
Kilitli RFID kodlu emniyet salteri CTP	126076	12-02/18		 2.4 MB
Chave de segurança codifi cada por transponder CTP com bloqueio	126214	12-02/18		 2.3 MB
Bezpečnostní spínac CTP s kódovaným transpondérem a jištením ochranného krytu	126604	12-02/18		 2.3 MB
带锁定功能的 CTP应答式编码 安全开关	158439	12-02/18		 2.4 MB







- Transpondercodierte Sicherheitsschalter - Verriegelungseinrichtungen und Zuhaltungen Transponder-coded safety switches - Interlocking devices and guard locking devices Interruptores de seguridad con codificación por transponder - Dispositivos de enclavamiento y bloqueos Interrupteurs de sécurité à codage par transpondeur - Dispositifs de verrouillage et interverrouillages

	Doc. no.	Version	Language	Download
Transpondercodierte Sicherheitsschalter - Verriegelungseinrichtungen und Zuhaltungen	127594	02-01/18		 5.2 MB
Interrupteurs de sécurité à codage par transpondeur - Dispositifs de verrouillage et interverrouillages	137558	02-01/18		 5.2 MB
Interruptores de seguridad con codificación por transponder - Dispositivos de enclavamiento y bloqueos	137560	02-01/18		 5.2 MB
Transponder-coded safety switches - Interlocking devices and guard locking devices	127595	02-01/18		 5.1 MB

Declaration of conformity

- EU-Konformitätserklärung

Doc. no. Version Language Download

EU-Konformitätserklärung	2123042	06-08/18		 0.4 MB
EU declaration of conformity				
Declaración UE de conformidad				
Déclaration UE de conformité				
Dichiarazione di conformità				

CAD data

CAD data for this item on TraceParts