

ITEM 103221 N1AR508-MC2222

Description	Technical data	Accessories	Downloads
-------------	----------------	-------------	-----------

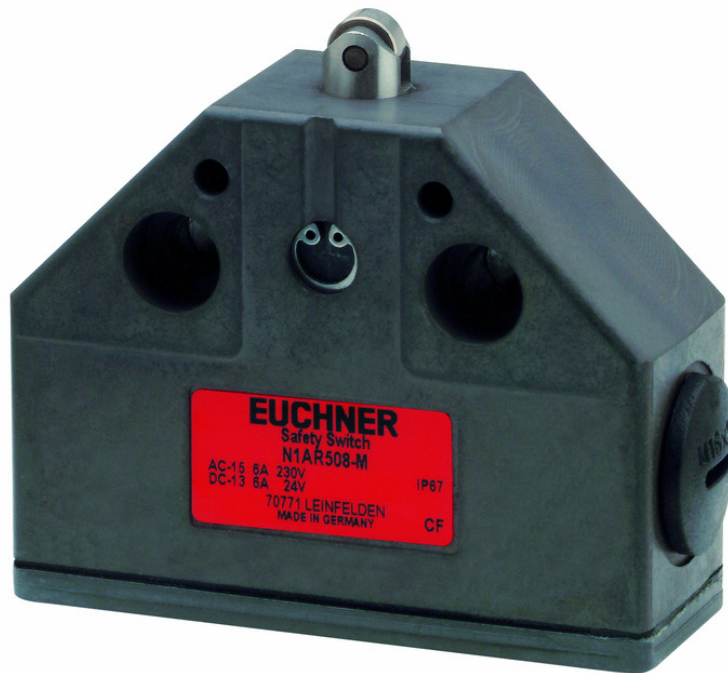

Features

- › Housing according to DIN 43693
- › Steel roller \varnothing 8 mm
- › Low temperature down to -40 °C

Approach direction

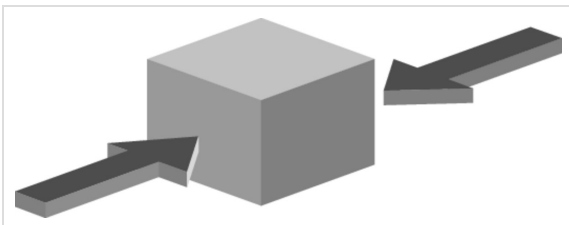

- › Figure
Horizontal
Can be adjusted in 90° steps

Low temperature

Version C2222 with silicone membrane and low temperature grease.

Switching element

508 Slow-action switching contact 1 NC ⊖

⚠ To achieve the positively driven travel, the dimension ①2-0,5 must be maintained by the trip dog. Actuating elements such as dog approach guides must be firmly mounted in accordance with EN ISO 14119, i.e. riveted, welded or otherwise secured against becoming loose.

Approvals



Mechanical values and environment

Design		Housing according to DIN 43693
Housing material		Anodized die-cast alloy
Weight	Net	0,2 kg
Ambient temperature		-40 ... 80 °C
Degree of protection		IP67
Mechanical life		$>1 \times 10^6$
Contact material		Silver alloy, gold flashed
Switching principle		Slow-action switching contact
Installation position		Any
Number of door position positively driven contacts		1
Connection	2 x	M16 x 1.5
Approach speed	max.	0,01 ... 80 m/min
Actuating element	Plain bearing	Roller plunger
Actuating force		min.15 N

Electrical connection ratings

Rated thermal current I_{th}		10 A
Utilization category according to EN 60947-5-1	AC-15	6A 230V
	DC-13	6A 24V
Short circuit protection according to IEC 60269-1	(Fuse)	10A gG
Rated insulation voltage U_i		250 V
Rated impulse withstand voltage U_{imp}		4 kV

Switching current	Min. at DC 24V 10 mA
Connection cross-section	0,34 ... 1,5 mm ²

Miscellaneous

C number	C2222 [1]
----------	-----------

Reliability values acc. to EN ISO 13849-1

	Monitoring of the safety guard position
B10 _D	20 x 10 ⁶

[1] With silicone diaphragm + low-temperature grease

Dimension drawing

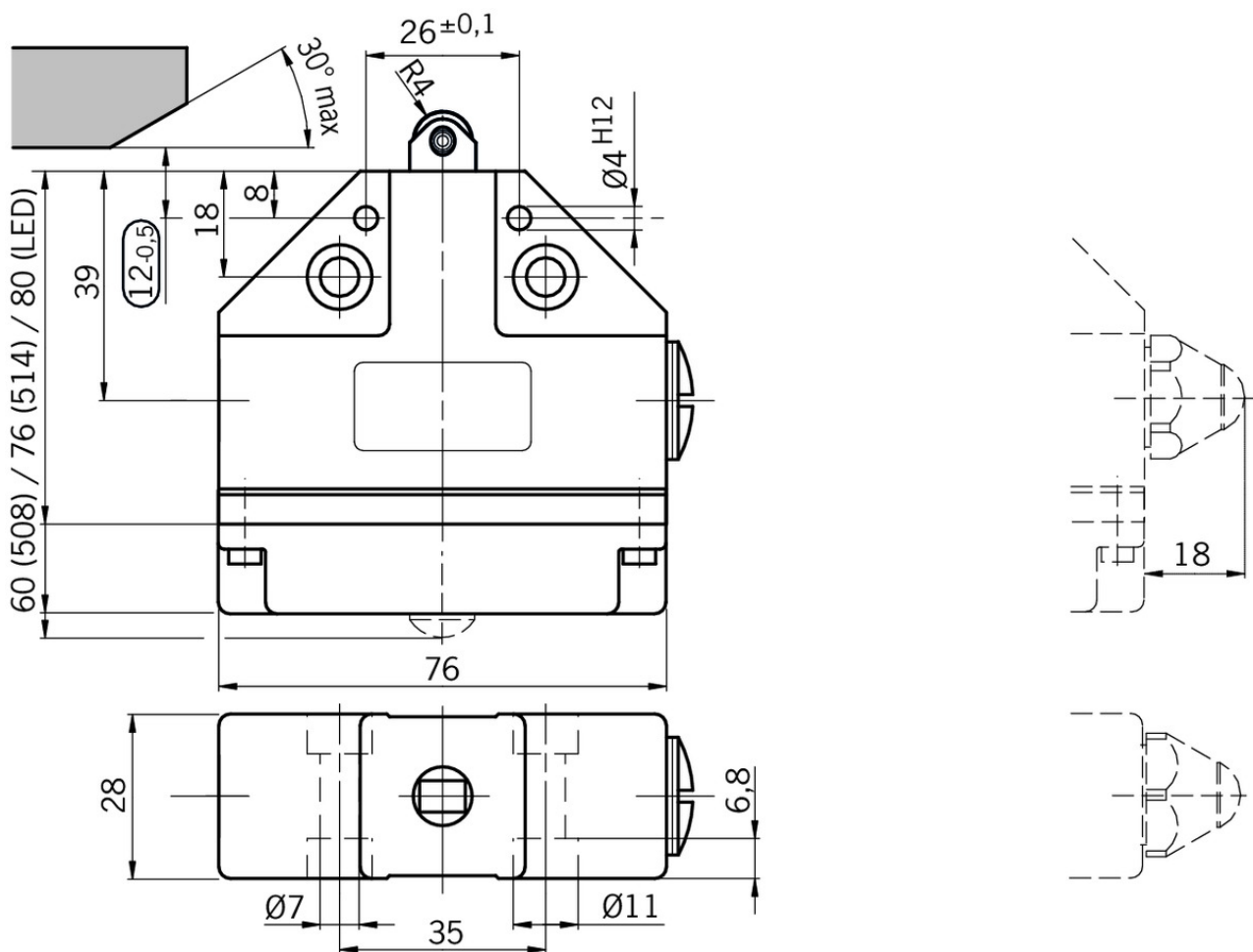

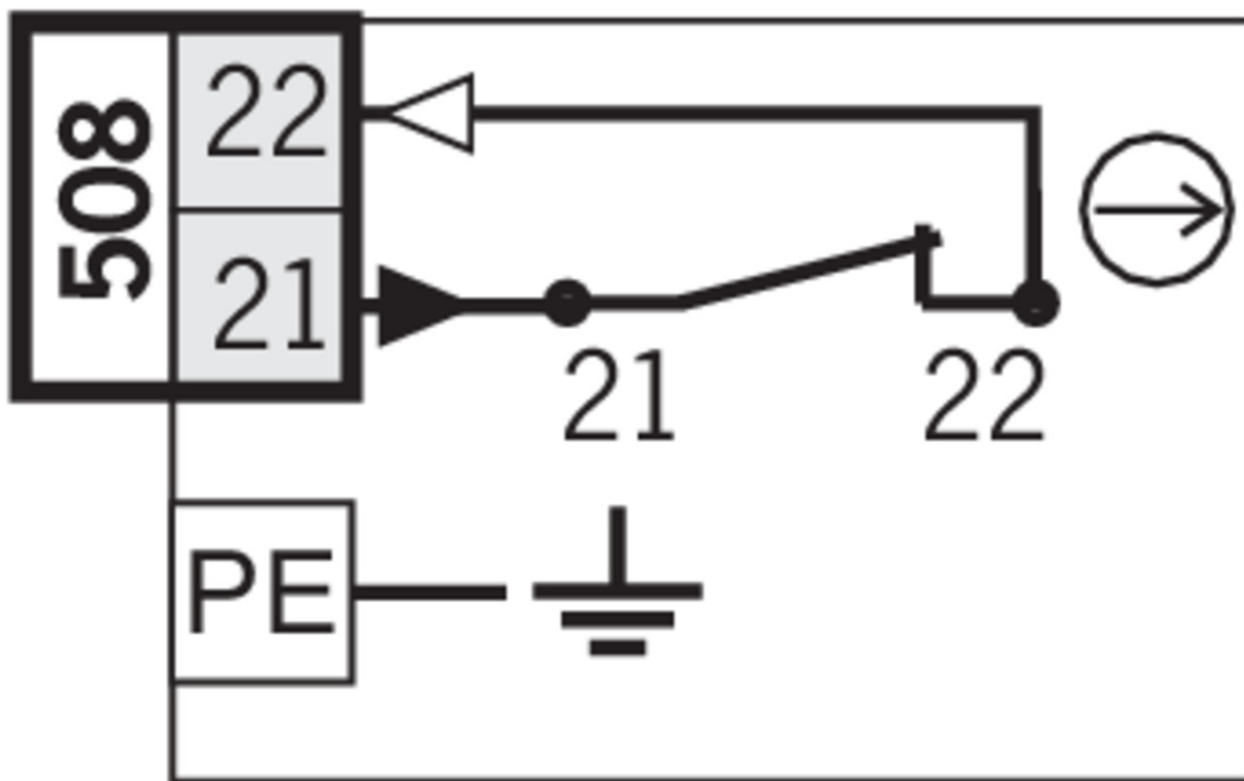

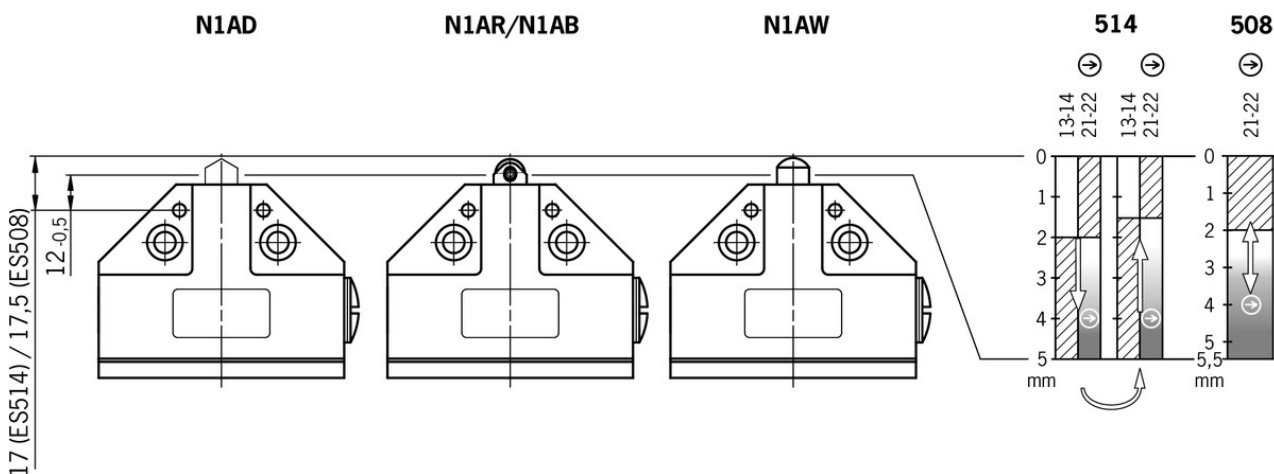

Travel diagram



Legende

-  Contacts closed
-  Contacts open
-  Contacts positively driven

▼ Cable glands M16x1.5



084572 EKPM16/05



086330 EKVM16/06



086328 EKVM16/04

Instructions

▼ Manual de instrucciones Finales de carrera unitarios de precisión N1A

	Doc. no.	Version	Language	Download
Betriebsanleitung Präzisions-Einzelgrenztaster N1A Operating Instructions Precision Single Limit Switches N1A	2032309	12-01/18	 	0.8 MB
Mode d'emploi Monopistes de précision N1A	2032309	12-01/18		0.4 MB
Manual de instrucciones Finales de carrera unitarios de precisión N1A	2032309	12-01/18		0.4 MB
Istruzioni di impiego Finecorsa di precisione singoli N1A	2032309	12-01/18		0.4 MB

Catalogs

▼ Positionsschalter und Reihengrenztaster Position Switches and Multiple Limit Switches
Interrupteurs de position et boîtiers multipistes

	Doc. no.	Version	Language	Download
Positionsschalter und Reihengrenztaster	157835	01-03/18		4.1 MB
Interrupteurs de position et boîtiers multipistes	157837	01-03/18		4.1 MB
Position Switches and Multiple Limit Switches	157836	01-03/18		4.1 MB

▼ Sicherheitsschalter mit Metallgehäuse Safety Switches with Metal Housing Bezpečnostní spínače s kovovým pouzdrém Interrupteurs de sécurité avec boîtier métallique 金属壳体 的安全开关
Interruptores de seguridad con carcasa metálica

	Doc. no.	Version	Language	Download
Sicherheitsschalter mit Metallgehäuse	100319	11-03/18		7.9 MB
Interrupteurs de sécurité avec boîtier métallique	100676	11-03/18		7.9 MB
Interruptores de seguridad con carcasa metálica	104856	11-03/18		14.0 MB
Safety Switches with Metal Housing	100369	11-03/18		7.9 MB
Bezpečnostní spínače s kovovým pouzdrém	121650	11-03/18		7.9 MB
金属壳体 的安全开关	102453	11-03/18		8.2 MB

Declaration of conformity

 EU prohlášení o shodě

	Doc. no.	Version	Language	Download
EU-Konformitätserklärung Declaración UE de conformidad Déclaration UE de conformité Dichiarazione di conformità EU declaration of conformity	2077153	25-02/17	    	 0.3 MB
EU prohlášení o shodě EU-overensstemmelseserklæring Δήλωση συμμόρφωσης της ΕΕ EU-vaatimustenmukaisuusvakuutus EU-típusbizonyítvány EU-conformiteitsverklaring Deklaracja zgodności UE Declaração de Conformidade UE Declarația de conformitate UE EÚ vyhlásenie o zhode	2077153	25-02/17	         	 0.5 MB