

## ITEM 122675 A-C-H-RO-LS-122675

Description	Technical data	Accessories	Downloads
-------------	----------------	-------------	-----------

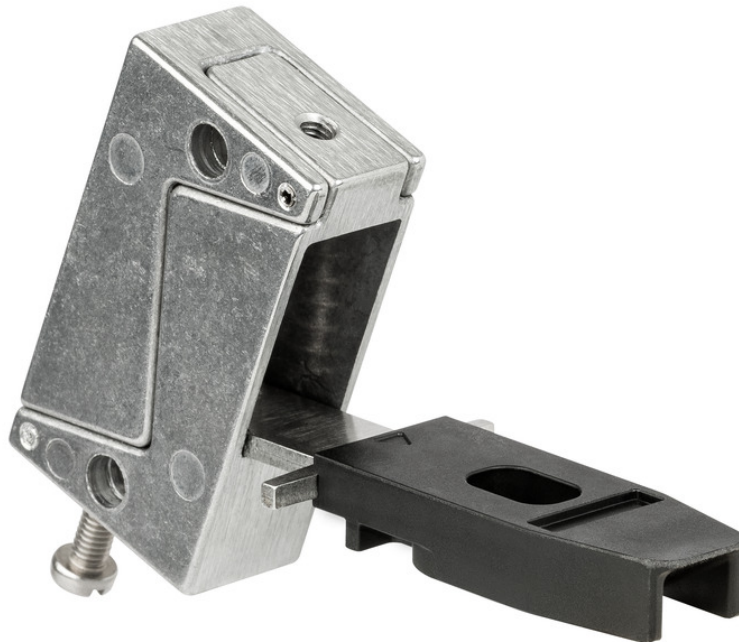

### Features

- › Hinged actuator for doors hinged at the top
- › Two safety screws included

### Hinged actuator

For door radii less than 1000 mm a hinged actuator should be used. The spring action movement of the actuator prevents damage due to the actuator jamming in the actuator head. Depending on the movement of the safety guard, the actuator must be selected for left, right, top or bottom.

The safety screws included can be inserted with a normal tool, but cannot be removed again.

### Mechanical values and environment

Housing material	Encapsulation	Fiber reinforced plastic, black
	Mounting range	Die-cast aluminum
Weight		0,06 kg

Ambient temperature	-20 ... 55 °C
Degree of protection	IP67 / IP69
Mechanical life	$1 \times 10^6$
Installation position	Any
Locking force $F_{max}$	2600 N
Locking force $F_{Zh}$	2000 N [1]
Overtravel	5 mm

## Electrical connection ratings

Power supply	Inductive via read head
--------------	-------------------------

[1]  $F_{zh} = F_{max}/1.3$

## Dimension drawing

122676 A-C-H-RU-LS-122676

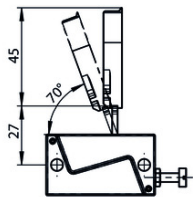

122675 A-C-H-RO-LS-122675

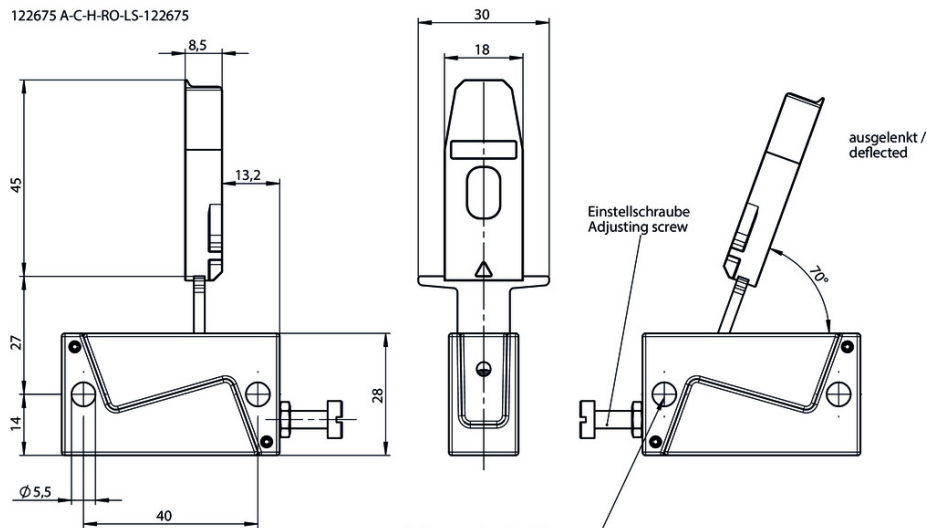

2x Einwegschraube M5  
beigelegt  
2x Non-removable screws M5  
included

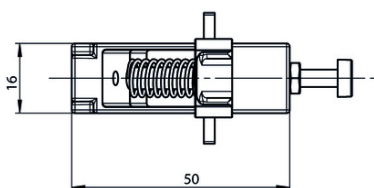

## Dimension drawing

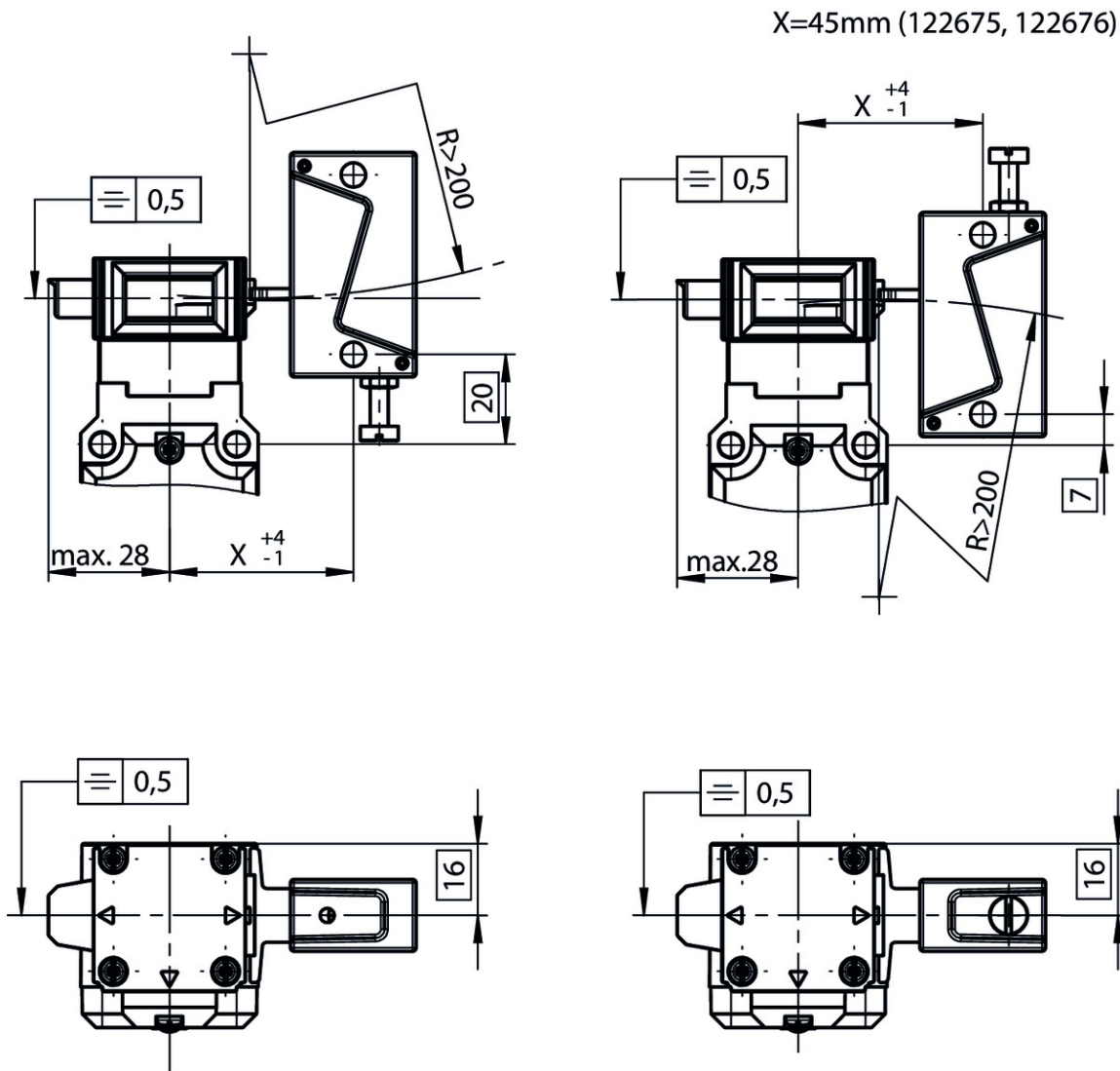

## Mounting accessories

- ✓ Safety screws M5 x 25

**073457** M5X25/V100























- ✓ Features



- › Safety screws M5 x 25
- › Packaging unit 100 pieces

## Catalogs

- ✓ Sicherheitsschalter CTP mit integriertem AS-Interface

Doc. no.    Version    Language    Download



Sicherheitsschalter CTP mit integriertem AS-Interface Safety switch CTP with integrated AS-Interface	126118	01-11/15	 	 0.8 MB
<b>▼</b> Interruptor de seguridad CTP con AS-Interface integrado				
	<b>Doc. no.</b>	<b>Version</b>	<b>Language</b>	<b>Download</b>
Interruptor de seguridad CTP con AS-Interface integrado Interrupteur de sécurité CTP avec AS-Interface intégrée	126958	01-11/15	 	 0.3 MB
<b>▼</b> ガード・ロック付き トランスポンダー・コード化 安全スイッチCTP				
	<b>Doc. no.</b>	<b>Version</b>	<b>Language</b>	<b>Download</b>
ガード・ロック付き トランスポンダー・コード化 安全スイッチCTP	136411	09-03/16		 1.8 MB
<b>▼</b> Bedienelemente integriert - der neue Sicherheitsschalter CTP-Extended				
	<b>Doc. no.</b>	<b>Version</b>	<b>Language</b>	<b>Download</b>
Bedienelemente integriert - der neue Sicherheitsschalter CTP-Extended Integrated controls - the new safety switch CTP-Extended	137356	01-11/16	 	 0.5 MB
<b>▼</b> Elementos de mando integrados: el nuevo interruptor de seguridad CTP-Extended				
	<b>Doc. no.</b>	<b>Version</b>	<b>Language</b>	<b>Download</b>
Elementos de mando integrados: el nuevo interruptor de seguridad CTP-Extended Éléments de commande intégrés - le nouvel interrupteur de sécurité CTP-Extended	137535	01-11/16	 	 0.5 MB
<b>▼</b> Transpondercodierter Sicherheitsschalter CTP mit Zuhaltung transponder-coded safety switch CTP with guard locking Interrupteur de sécurité à codage par transpondeur CTP avec interverrouillage Interruptor de seguridad CTP codificado por transponder con bloqueo Finecorsa di sicurezza con codifica a transponder CTP con meccanismo di ritenuta Kilitli RFID kodlu emniyet salteri CTP Chave de segurança codificada por transponder CTP com bloqueio Bezpečnostní spínač CTP s kódovaným transpondérem a jištěním ochranného krytu 带锁定功能的CTP应答式编码安全开关				
	<b>Doc. no.</b>	<b>Version</b>	<b>Language</b>	<b>Download</b>
Transpondercodierter Sicherheitsschalter CTP mit Zuhaltung	123243	12-02/18		 2.3 MB
Interrupteur de sécurité à codage par transpondeur CTP avec interverrouillage	123245	12-02/18		 2.3 MB
Interruptor de seguridad CTP codificado por transponder con bloqueo	123246	12-02/18		 2.3 MB
transponder-coded safety switch CTP with guard locking	123244	12-02/18		 2.3 MB
Finecorsa di sicurezza con codifica a transponder CTP con meccanismo di ritenuta	126042	12-02/18		 2.3 MB
Kilitli RFID kodlu emniyet salteri CTP	126076	12-02/18		 2.4 MB
Chave de segurança codificada por transponder CTP com bloqueio	126214	12-02/18		 2.3 MB
Bezpečnostní spínač CTP s kódovaným transpondérem a jištěním ochranného krytu	126604	12-02/18		 2.3 MB

带锁定功能的 CTP应答式编码 安全开关 158439 12-02/18   2.4 MB



- ▼ Transpondercodierte Sicherheitsschalter - Verriegelungseinrichtungen und Zuhaltungen  
Transponder-coded safety switches - Interlocking devices and guard locking devices  
Interruptores de seguridad con codificación por transponder - Dispositivos de enclavamiento y bloqueos  
Interrupteurs de sécurité à codage par transpondeur - Dispositifs de verrouillage et interverrouillages

	Doc. no.	Version	Language	Download
Transpondercodierte Sicherheitsschalter - Verriegelungseinrichtungen und Zuhaltungen	127594	02-01/18		 5.2 MB
Interrupteurs de sécurité à codage par transpondeur - Dispositifs de verrouillage et interverrouillages	137558	02-01/18		 5.2 MB
Interruptores de seguridad con codificación por transponder - Dispositivos de enclavamiento y bloqueos	137560	02-01/18		 5.2 MB
Transponder-coded safety switches - Interlocking devices and guard locking devices	127595	02-01/18		 5.1 MB

- ▼ Eingeschlossen ausgeschlossen - der neue Sicherheitsschalter CTP-BI

	Doc. no.	Version	Language	Download
Eingeschlossen ausgeschlossen - der neue Sicherheitsschalter CTP-BI No chance of getting locked-in - the new safety switch CTP-BI	137349	02-07/18	 	 0.4 MB

- ▼ Imposible quedarse encerrado: el nuevo CTP-BI

	Doc. no.	Version	Language	Download
Imposible quedarse encerrado: el nuevo CTP-BI Enfermement exclu - le nouveau CTP-BI	137534	02-07/18	 	 0.4 MB

## CAD data

CAD data for this item on TraceParts