

ITEM 124988 CTP-L2-AS1B-U-HA-AZ-SJ-124988

Description	Technical data	Accessories	Downloads
-------------	----------------	-------------	-----------



Features

- › Safety switch with guard locking and integrated evaluation electronics
- › Locking force up to 3,900 N
- › Category 4/PL e according to EN ISO 13849-1
- › Unicode
- › Approach directions A, B and C (delivery state)

Approach direction

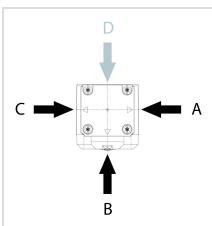

- › Figure
Horizontal
Can be adjusted in 90° steps

Guard locking type

CTP-L2 Guard locking actuated by power-ON applied and spring released (open-circuit current principle).

Control of the guard locking solenoid

The guard locking solenoid can be controlled via AS-Interface bus bit D0 or via the auxiliary power.

AS-Interface inputs

D0, D1 Door monitoring

D2, D3 Guard lock monitoring

Evaluation is performed via a safety monitor.

AS-Interface outputs

D0 Guard locking

LED function display

- › The ASI LED indicates the state of the ASi bus.
- › The STATE LED indicates the state of the switch.
- › The LOCK/DIA LED indicates if the door is locked and whether a fault has been detected in the switch.

Approvals



Mechanical values and environment

Housing material	
Switch head cover	Die-cast zinc
Safety switch housing	Fiber glass reinforced thermoplastic
Weight	
Net	0,42 kg
Ambient temperature	-20 ... +55 °C
Degree of protection	IP67 / IP69 / IP69K [1]
Resilience to vibration	In acc. with EN IEC 60947-5-3
Mechanical life	1 x 10 ⁶
Installation position	Any
Ready delay	max.1 s
Switching frequency	max.0,5 Hz
Connection	1 plug connector M12, 4-pin
Approach speed	20 m/min
Guard locking principle	Open-circuit current principle

Locking force F_{\max}	3900 N
Locking force F_{Z_h}	3000 N [2]
Retention force	20 N
Extraction force	20 N
Actuating force	10 N
Overtravel	5 mm

Electrical connection ratings

ASi voltage	26,5 ... 30 V 31,6 V
ASi operating current	50 mA
ASi auxiliary voltage	
IEC 60742, PELV	24 V -15% ... +10%
ASi auxiliary current	400 mA
ASi slave type	
According to ASI specification 3.0	EA code: 7
According to ASI specification 3.0	ID code: B
ASi data in	
According to As-i Safety at Work	D0 [3]
According to As-i Safety at Work	D1 [4]
According to As-i Safety at Work	D2 [5]
According to As-i Safety at Work	D3 [6]
ASi data out	
Guard locking solenoid	D0 [7]
Safety class	
EN IEC 61140	III

Operating distance

Repeat accuracy R	
According to EN 60947-5-2	10 %

Miscellaneous

For the approval according to UL the following applies	Operation only with UL class 2 power supply, or equivalent measures see operating instructions
--	--

Reliability values acc. to EN ISO 13849-1

Performance Level	PL e
Category	4
PFH _D	4.3×10^{-9}
Mission time	20 y

- [1] Screwed tight plug connector/mating component
- [2] $F_{zh} = F_{max}/1.3$ Depending on the actuator used
- [3, 4] Door position
- [5, 6] Guard locking
- [7] 1 = Solenoid energized

Dimension drawing

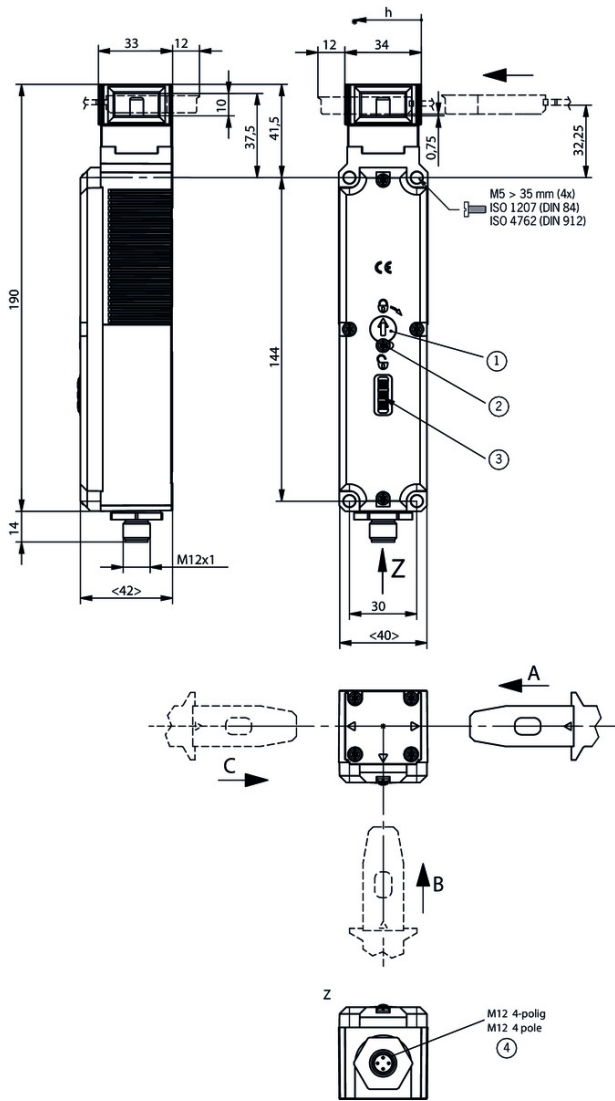

Legende

- 1 Auxiliary release
- 2 Locking screw
- 3 LEDs
- 4 Plug connector not aligned

Wiring diagram

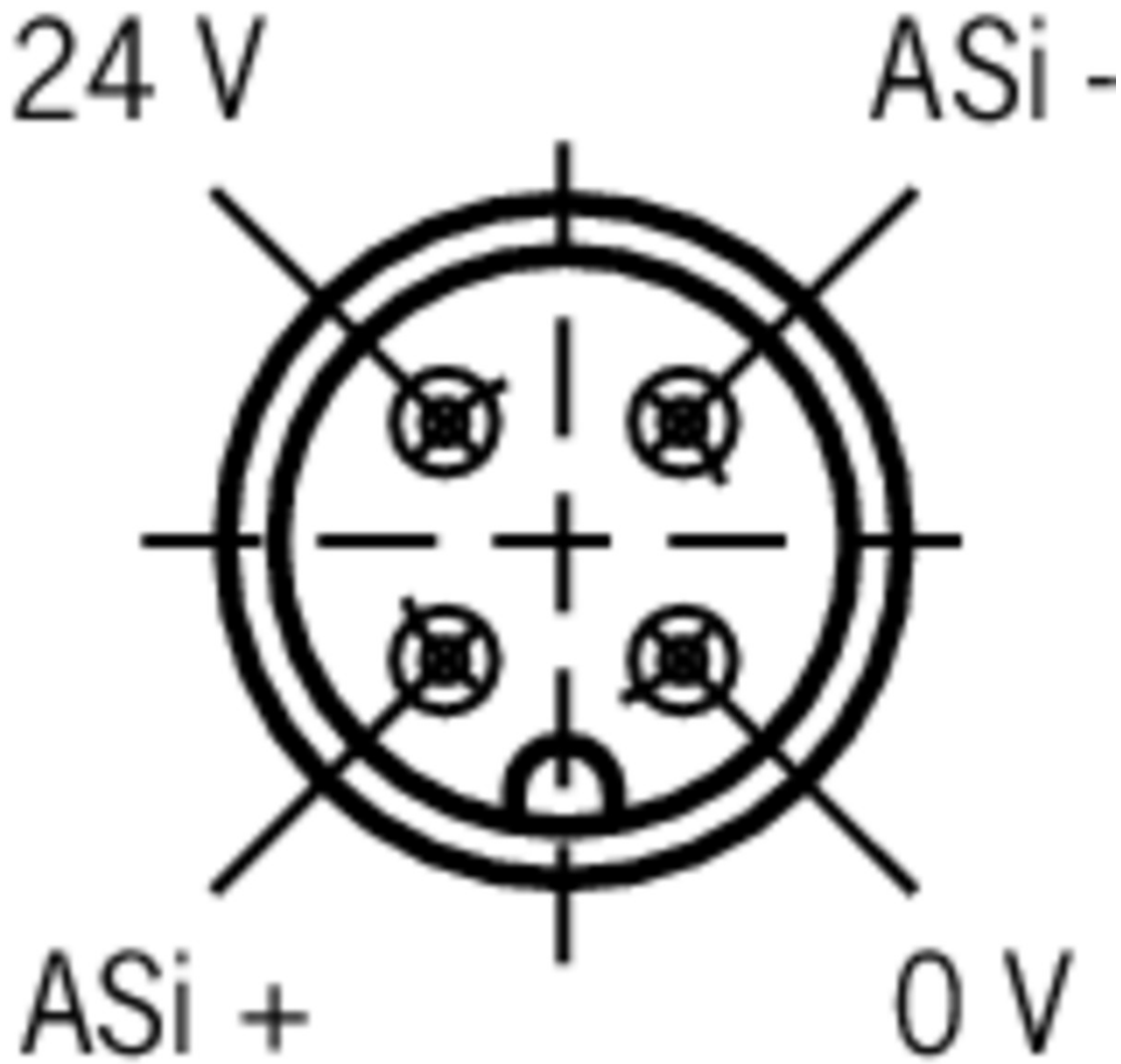

Actuator

- ▼ Bent actuator for safety switches CTP



122667 A-C-H-W-SST-122667

▼ Features

- › Actuator bent at top
- › Two safety screws included



122668 A-C-H-W-SST-122668

▼ Features

- › Actuator bent at bottom
- › Two safety screws included

- ▼ Hinged actuator for safety switch CTP



122675 A-C-H-RO-LS-122675

▼ Features

- › Hinged actuator for doors hinged at the top

- › Two safety screws included



122676 A-C-H-RU-LS-122676

✓ Features

- › Hinged actuator for doors hinged at the bottom
- › Two safety screws included



122671 A-C-H-RL-LS-122671

✓ Features

- › Hinged actuator for doors hinged on the left
- › Two safety screws included



122672 A-C-H-RR-LS-122672

✓ Features

- › Hinged actuator for doors hinged on the right
- › Two safety screws included

✓ Straight actuator for safety switch CTP



126015 A-C-H-G-SST-126015

✓ Features

- › Straight actuator
- › Two safety screws included

Bolt

✓ Bolts for safety switches series CTP



123653 RIEGEL CTP-AC-123653

✓ Features

- › Steel bolt
- › For doors hinged on right and left
- › Can be locked in open position with padlocks
- › Actuator included

✓ Bolt BTC-CTP-S for safety switch CTP



123659 BTC-CTP-S-TH-00-X

✓ Features

- › Aluminum bolt
- › For doors hinged on the left or right
- › Can be locked in open position with padlocks
- › Actuator included

✓ Bolt CTP-GFK for safety switch CTP



123657 RIEGEL CTP-GFK

✓ Features

- › Fiber glass reinforced plastic bolt

- › For doors hinged on the left or right
- › Can be locked in open position with padlocks
- › Actuator included

Function expansion

Lockout mechanism CTP



123411 AE-L-C-H-123411

Features

- › Prevents unintentional closing of the door
- › Can be secured with padlocks

Mounting accessories

Mounting plates AM-P for safety switches CTP



126026 AM-P-126026

Features

- › For vertical and horizontal mounting of safety switch CTP

Connection material

Bus coupling module with plug connector M12, 5-pin



105756 BCM-A-P2-SEM4-1

Features



- › Conversion from M12 to ribbon cable
- › Very compact design
- › Easy handling

Instructions

Betriebsanleitung Transpondercodierter Sicherheitsschalter mit Zuhaltung CTP-L.-AS1 Uni-/Multicode



	Doc. no.	Version	Language	Download
Betriebsanleitung Transpondercodierter Sicherheitsschalter mit Zuhaltung CTP-L.-AS1 Uni-/Multicode	2124662	03-05/18		2.9 MB
Operating Instructions Transponder-Coded Safety Switch With Guard Locking CTP-L.-AS1 Unicode/Multicode	2124662	03-05/18		2.9 MB

Sicherheitsinformation und Wartung CET.-AS/CTP.-AS



	Doc. no.	Version	Language	Download
Sicherheitsinformation und Wartung CET.-AS/CTP.-AS Safety Information and Maintenance CET.-AS/CTP.-AS	113769	03-11/15	 	 0.3 MB

Catalogs

▼ Sicherheitsschalter CTP mit integriertem AS-Interface

	Doc. no.	Version	Language	Download
Sicherheitsschalter CTP mit integriertem AS-Interface Safety switch CTP with integrated AS-Interface	126118	01-11/15	 	 0.8 MB







▼ Interruptor de seguridad CTP con AS-Interface integrado

	Doc. no.	Version	Language	Download
Interruptor de seguridad CTP con AS-Interface integrado Interrupteur de sécurité CTP avec AS-Interface intégrée	126958	01-11/15	 	 0.3 MB









▼ ガード・ロック付き トランスポンダー・コード化 安全スイッチCTP

	Doc. no.	Version	Language	Download
ガード・ロック付き トランスポンダー・コード化 安全スイッチCTP	136411	09-03/16		 1.8 MB

▼ Sicherheitsschalter mit AS-Interface Safety Switches with AS-Interface Interrupteurs de sécurité avec AS-Interface

	Doc. no.	Version	Language	Download
Sicherheitsschalter mit AS-Interface	092164	11-04/17		 2.3 MB
Interrupteurs de sécurité avec AS-Interface	112564	11-04/17		 2.3 MB
Safety Switches with AS-Interface	092332	11-04/17		 2.3 MB



▼ Transpondercodierter Sicherheitsschalter CTP mit Zuhaltung transponder-coded safety switch CTP with guard locking Interrupteur de sécurité à codage par transpondeur CTP avec interverrouillage Interruptor de seguridad CTP codifi cado por transponder con bloqueo Finecorsa di sicurezza con codifi ca a transponder CTP con meccanismo di ritenuta Kilitli RFID kodlu emniyet salteri CTP Chave de segurança codifi cada por transponder CTP com bloqueio Bezpečnostní spínac CTP s kódovaným transpondérem a jištěním ochranného krytu 帶鎖定功能的 CTP应答式編碼 安全开关

	Doc. no.	Version	Language	Download
Transpondercodierter Sicherheitsschalter CTP mit Zuhaltung	123243	12-02/18		 2.3 MB
Interrupteur de sécurité à codage par transpondeur CTP avec interverrouillage	123245	12-02/18		 2.3 MB
Interruptor de seguridad CTP codifi cado por transponder con bloqueo	123246	12-02/18		 2.3 MB
transponder-coded safety switch CTP with guard locking	123244	12-02/18		 2.3 MB
Finecorsa di sicurezza con codifi ca a transponder CTP con meccanismo di ritenuta	126042	12-02/18		 2.3 MB

Kilitli RFID kodlu emniyet salteri CTP	126076	12-02/18		 2.4 MB
Chave de segurança codifi cada por transponder CTP com bloqueio	126214	12-02/18		 2.3 MB
Bezpečnostní spínac CTP s kódovaným transpondérem a jištěním ochranného krytu	126604	12-02/18		 2.3 MB
带锁定功能的 CTP应答式编码 安全开关	158439	12-02/18		 2.4 MB

Declaration of conformity

EU-Konformitätserklärung

	Doc. no.	Version	Language	Download
EU-Konformitätserklärung	2123042	06-08/18		 0.4 MB
EU declaration of conformity				
Declaración UE de conformidad				
Déclaration UE de conformité				
Dichiarazione di conformità			