

## ITEM 079033 ADAPTER NZ/TZ 45/30

Description	Technical data	Accessories	Downloads
-------------	----------------	-------------	-----------

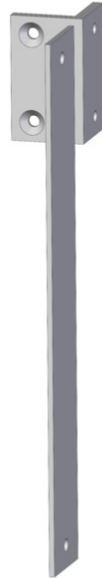

### Features

- › The adapter NZ/TZ 45/30 is used to compensate for different profiles, doors/frame 45/30

### Mechanical values and environment

Material	Galvanized steel
Weight	Net 0,35 kg

## Dimension drawing

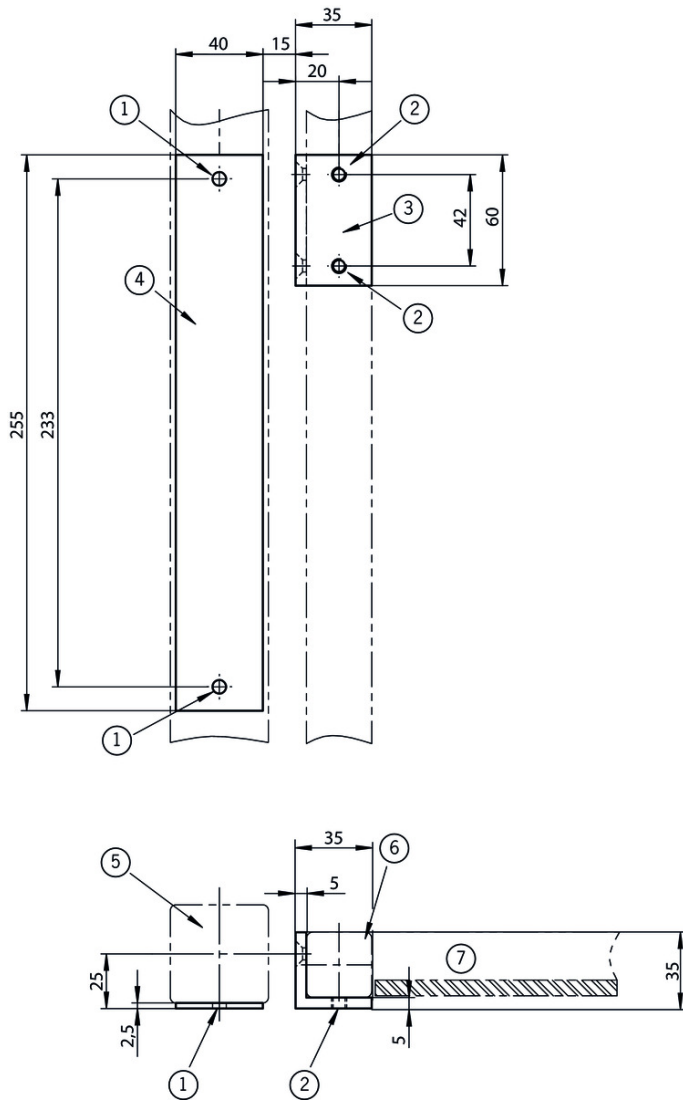













## Legende

- 1 Bore for screw M6
- 2 Thread for screw M6
- 3 Adapter angle
- 4 Adapter plate
- 5 Safety guard frame (45x45)
- 6 Door frame (30x30)
- 7 Door hinged on the right

## Catalogs

- ✓ Sicherheitsschalter mit Metallgehäuse Safety Switches with Metal Housing Bezpečnostní spínače

s kovovým pouzdem Interrupteurs de sécurité avec boîtier métallique 金属壳体 的安全开关  
Interruptores de seguridad con carcasa metálica

	<b>Doc. no.</b>	<b>Version</b>	<b>Language</b>	<b>Download</b>
Sicherheitsschalter mit Metallgehäuse	100319	11-03/18		 7.9 MB
Interrupteurs de sécurité avec boîtier métallique	100676	11-03/18		 7.9 MB
Interruptores de seguridad con carcasa metálica	104856	11-03/18		 14.0 MB
Safety Switches with Metal Housing	100369	11-03/18		 7.9 MB
Bezpečnostní spínače s kovovým pouzdem	121650	11-03/18		 7.9 MB
金属壳体 的安全开关	102453	11-03/18		 8.2 MB