

## ITEM 126400 AM-P-126400

Description	Technical data	Accessories	Downloads
-------------	----------------	-------------	-----------



### Features

- › Mounting plate for CET actuator
- › Suitable for mounting on aluminum profiles of width 30/40/50 mm
- › Suitable for the mounting plates AM-P-126399 and AM-P-126398

### Mechanical values and environment

Material	Aluminum
Weight	
	Net 0,1 kg

### Miscellaneous

Compatibility	CET
---------------	-----

# Dimension drawing

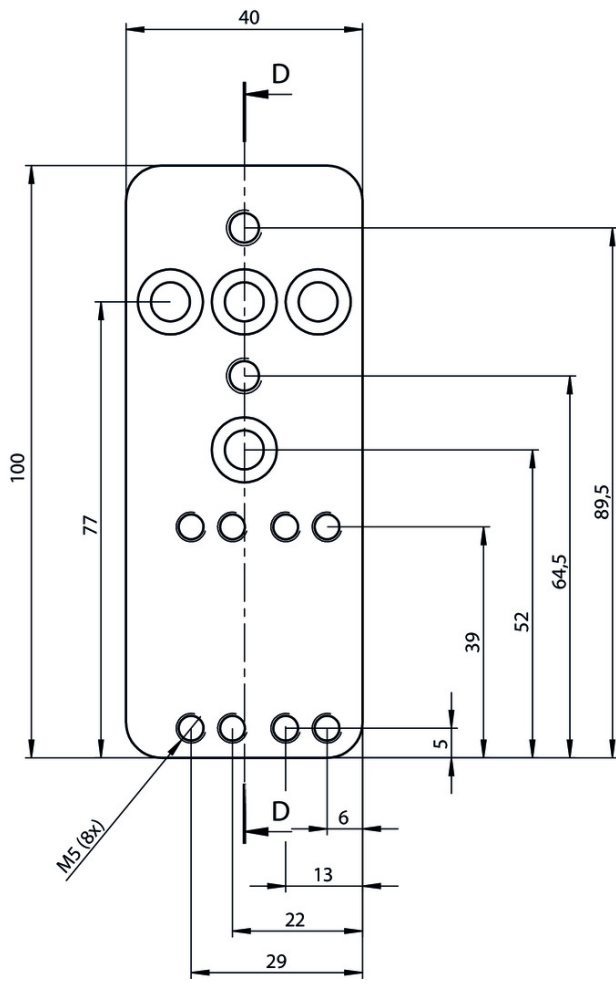

## D-D

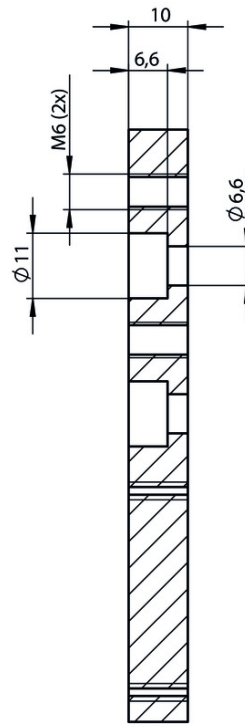

## Montagebeispiel

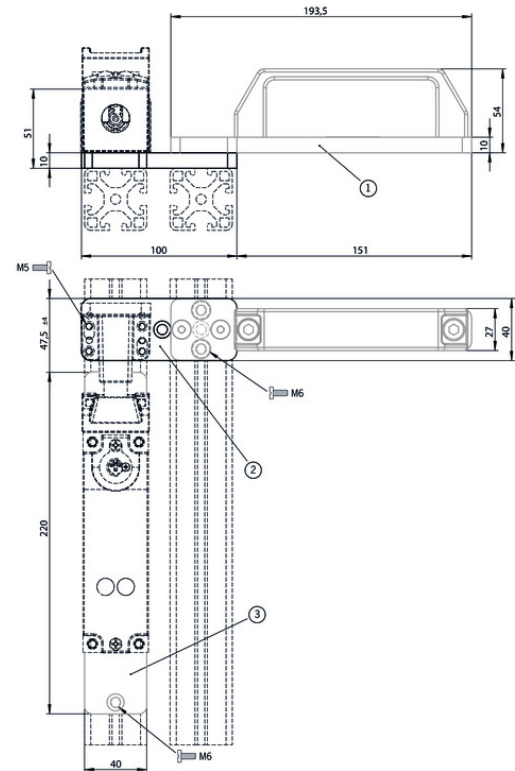
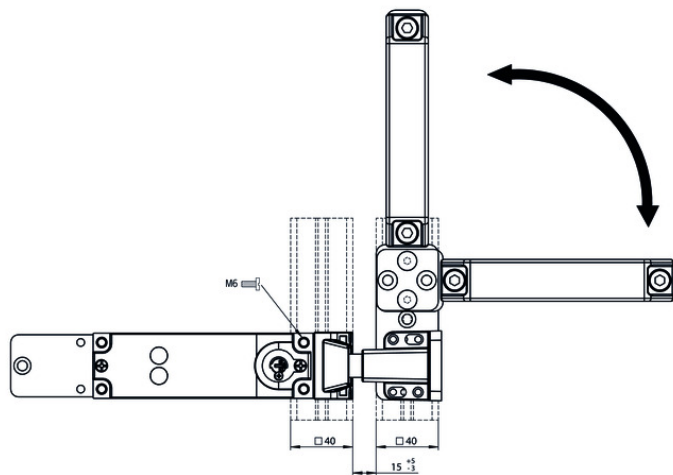
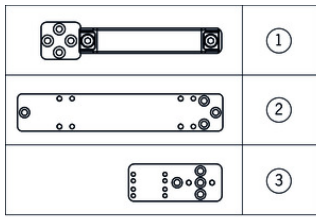

## Legende

- 1 AM-P-126398 mounting plate with handle
- 2 AM-P-126400 mounting plate CET actuator
- 3 AM-P-126399 mounting plate for CET read head/switch

## Mounting accessories

### ✓ Mounting plate EM-P handle for safety switch CET



#### **126398** AM-P-126398

##### ✓ Features

- › Mounting plate with handle (handle included)
- › For hinged or sliding doors
- › Horizontal and vertical assembly circuits possible
- › Suitable for aluminum profiles of width 30/40/50 mm
- › Suitable for the CET mounting plates AM-P-126399 and AM-P-126400

### ✓ Mounting plate EM-P switch for safety switch CET









#### **126399** AM-P-126399

##### ✓ Features



- › Mounting plate for CET read heads/switches
- › Direct mounting on aluminum profiles of width 30/40/50 mm

## Catalogs

- ▼ Transpondercodierte Sicherheitsschalter - Verriegelungseinrichtungen und Zuhaltungen  
 Transponder-coded safety switches - Interlocking devices and guard locking devices  
 Interruptores de seguridad con codificación por transponder - Dispositivos de enclavamiento y bloqueos  
 Interrupteurs de sécurité à codage par transpondeur - Dispositifs de verrouillage et interverrouillages

	Doc. no.	Version	Language	Download
Transpondercodierte Sicherheitsschalter - Verriegelungseinrichtungen und Zuhaltungen	127594	02-01/18		 5.2 MB
Interrupteurs de sécurité à codage par transpondeur - Dispositifs de verrouillage et interverrouillages	137558	02-01/18		 5.2 MB
Interruptores de seguridad con codificación por transponder - Dispositivos de enclavamiento y bloqueos	137560	02-01/18		 5.2 MB
Transponder-coded safety switches - Interlocking devices and guard locking devices	127595	02-01/18		 5.1 MB

- ▼ Transpondercodierte Sicherheitssysteme mit externer Auswertung  
 Transponder-coded safety systems with external evaluation  
 Sistemas de seguridad con codificación por transponder y evaluación externa  
 Systèmes de sécurité à codage par transpondeur avec analyse externe

	Doc. no.	Version	Language	Download
Transpondercodierte Sicherheitssysteme mit externer Auswertung	127596	02-01/18		 3.1 MB
Systèmes de sécurité à codage par transpondeur avec analyse externe	137968	02-01/18		 3.0 MB
Sistemas de seguridad con codificación por transponder y evaluación externa	139969	02-01/18		 3.0 MB
Transponder-coded safety systems with external evaluation	127597	02-01/18		 3.0 MB