

## ITEM 115585 STA4A-2131A024MF-EX

Description	Technical data	Accessories	Downloads
-------------	----------------	-------------	-----------



### Features

- › ATEX version
- › Suitable for usage in zone 2 and 22 (gases and dusts)
- › Auxiliary release on the front
- › With door monitoring contact

### Approach direction

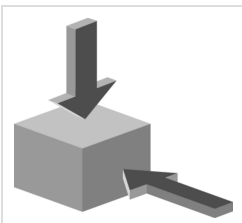

- › Figure  
Horizontal and vertical  
Can be adjusted in 90° steps

### Solenoid operating voltage

- › AC/DC 24 V +10%, -15%

## Guard locking type

**STA4** Open-circuit current principle, guard locking by applying voltage to the guard locking solenoid. Release by spring force.

## Switching element

**2131** Slow-action switching contact 2 NC  $\oplus$  + 1 NO + 1 NC (door monitoring contact)

## Auxiliary release

Is used for releasing the guard locking with the aid of a tool. To protect against tampering, the auxiliary release is sealed with sealing lacquer.

## Approvals



## Mechanical values and environment

Housing material	Die-cast alloy
Weight	
	Net 0,6 kg
Ambient temperature	-20 ... 75 °C
Degree of protection	IP67
Mechanical life	1 x 10 <sup>6</sup>
Contact material	Silver alloy, gold flashed
Switching principle	Slow-action switching contact
Installation position	Any
Number of door position NC contacts	1
Number of guard lock monitoring positively driven contacts	2
Number of guard lock monitoring NO contacts	1
Connection	
	3 x Cable gland M20 x 1.5
Clamping range for cable	6,5 ... 12 mm
Approach speed	
	max. 20 m/min
Actuation frequency	1200 1/h
Guard locking principle	Open-circuit current principle
Locking force F <sub>max</sub>	3000 N
Locking force F <sub>Zh</sub>	2300 N
Retention force	20 N
Extraction force	30 N

Actuating force	35 N
Insertion depth	min.24,5 mm

### Electrical connection ratings

Rated thermal current $I_{th}$	4 A
Utilization category according to EN 60947-5-1	AC-15 4A 50V DC-13 4A 24V
Solenoid operating voltage	AC/DC 24 V -15% ... +10%
Short circuit protection according to IEC 60269-1	(Fuse) 4A gG
Rated insulation voltage $U_i$	50 V
Rated impulse withstand voltage $U_{imp}$	2,5 kV
Switching voltage	Min. at 10mA 12 V
Switching current	Min. at 24V 1 mA
Power consumption	8 W
Solenoid duty cycle	100 %
Connection cross-section	0,34 ... 1,5 mm <sup>2</sup>

### Miscellaneous

Explosion protection	incl. cable gland II3G Ex nR IIB T4 Gc X /II3D Ex tc IIIC T110°C Dc X
----------------------	---

### Reliability values acc. to EN ISO 13849-1

	<b>Monitoring of guard locking and the safety guard position</b>
B10 <sub>D</sub>	11,5 x 10 <sup>6</sup>

### in combination with Actuator BETAETIGER-S-G-SN-C2115

### Mechanical values and environment

Overtravel	5 mm
------------	------

## Dimension drawing

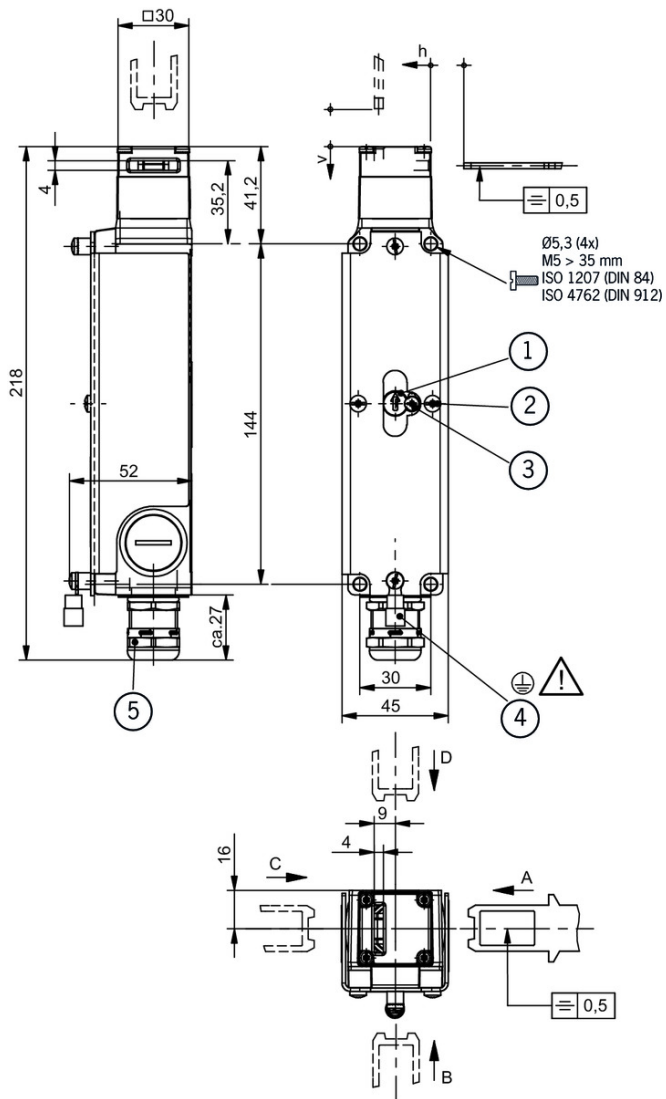

## Legende

- 1 Auxiliary release
- 2 Cover screw (4x M = 1.5 Nm)
- 3 Locking screw
- 4 Ground switch via cable lug to prevent electrostatic charging, cable cross-section 4...6 mm<sup>2</sup>
- 5 Cable gland included clamping range  $\varnothing 6.5 - 12$  mm

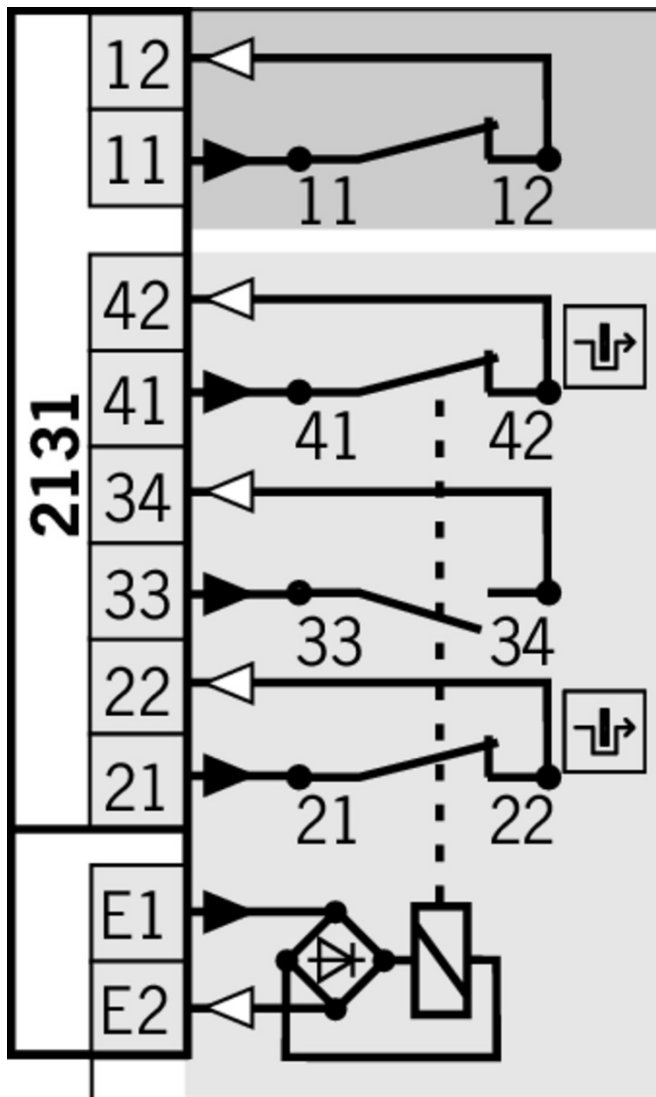

**Legende**

- Solenoid monitoring
- Door monitoring

## Switching functions

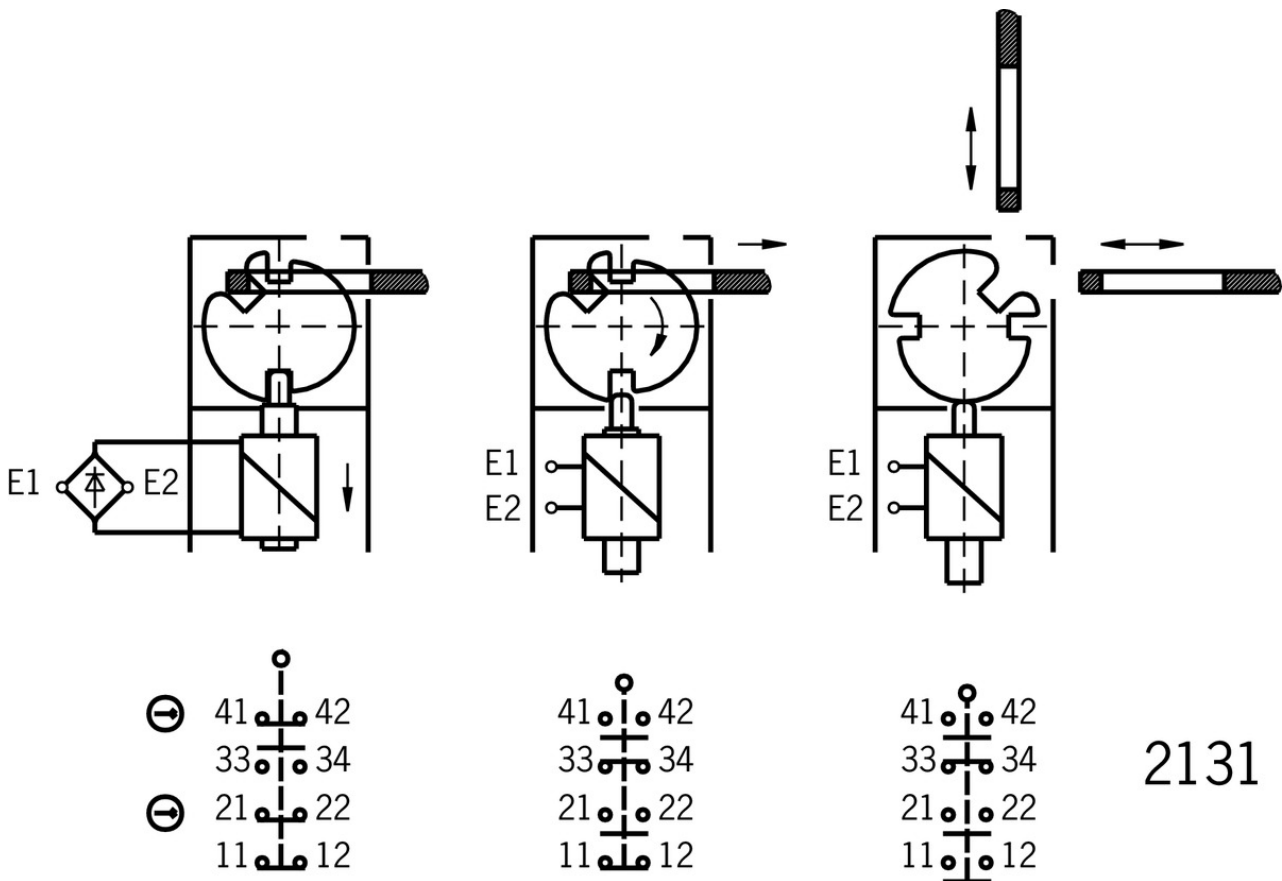

## Actuator

- ✓ Actuator S for safety switches SGA/SGP/STA/STP/STM



**097861** BETAETIGER-S-G-SN-C2115

✓ Features

- › Two safety screws included
- › Physically compatible with TP actuator P-G

- ✓ Hinged actuator S top/bottom for safety switches SGA/SGP/STA/STP/STM



**095315** RADIUSBETAETIGER-S-OU-SN

✓ Features

- › Actuators made of stainless steel
- › Two safety screws included
- › For doors hinged at top and bottom

- ✓ Hinged actuator S left/right for safety switches SGA/SGP/STA/STP/STM



**096838** RADIUSBETAETIGER-S-LR-SN

✓ Features

- › Actuators made of stainless steel
- › Two safety screws included
- › For doors hinged on right and left

- 
- ▼ Hinged actuator L top/bottom, for safety switches SGA/SGP/STA/STP/STM for insertion funnel



**096697** RADIUSBETAETIGER-S-OU-LN

▼ Features

- › Actuators made of stainless steel
- › Two stainless safety screws per actuator
- › For doors hinged at top and bottom

- 
- ▼ Hinged actuator L left/right, for safety switches SGA/SGP/STA/STP/STM for insertion funnel



**096844** RADIUSBETAETIGER-S-LR-LN

▼ Features

- › Actuators made of stainless steel
- › Two stainless safety screws per actuator
- › For doors hinged on right and left

- 
- ▼ Actuator S, bent, for safety switches SGA/SGP/STA/STP/STM



**115073** BETAETIGER-S-W-SN-C2115

▼ Features

- › Two stainless safety screws per actuator
- › Minimum door radius 300 mm

- 
- ▼ Actuator for safety switch SGA-EX/STA-EX



**158407** BETAETIGER-S-WQ-SN-C2498

▼ Features

- › Two safety screws included
- › Minimum door radius 300 mm

---

## Function expansion

- ▼ Insertion funnel for safety switches SGP/STA/STP/STM/SGA



**093157** EINFUEHRTRICHTER-S

- 
- ▼ Lockout bar STA/STP/SGA/SGP/STM



**105701** SPERREINSATZ STP/STA

▼ Features

- › Prevents unintentional closing of the door
  - › Can be secured with padlocks
-

## Instructions

### Manual de instrucciones del interruptor de seguridad STA...EX













	Doc. no.	Version	Language	Download
Betriebsanleitung Sicherheitsschalter STA...EX Operating Instructions Safety Switch STA...EX	2115582	05-02/18	 	 2.2 MB
Mode d'emploi pour les interrupteurs de sécurité STA...EX	2115582	05-02/18		 1.2 MB
Manual de instrucciones del interruptor de seguridad STA...EX	2115582	05-02/18		 1.2 MB
Istruzioni di impiego dei finecorsa di sicurezza STA...EX	2115582	05-02/18		 1.2 MB
Manual de instruções Chave de segurança STA...EX	2115582	05-02/18		 1.2 MB
使用说明书 安全开关 STA...EX	2115582	05-02/18		 1.6 MB

## Catalogs

### ATEX - Sicherheitsschalter für explosionsgefährdete Bereiche ATEX - Safety switches for potentially explosive atmospheres ATEX - Interrupteurs de sécurité pour atmosphères explosibles ATEX - Interruptores de seguridad para uso en atmósferas potencialmente explosivas

	Doc. no.	Version	Language	Download
ATEX - Sicherheitsschalter für explosionsgefährdete Bereiche	136804	03-04/17		 1.5 MB
ATEX - Interrupteurs de sécurité pour atmosphères explosibles	136806	03-04/17		 1.5 MB
ATEX - Interruptores de seguridad para uso en atmósferas potencialmente explosivas	136807	03-04/17		 1.5 MB
ATEX - Safety switches for potentially explosive atmospheres	136805	03-04/17		 1.0 MB

### Bezpečnostní spínače s plastovým pouzdrém Sicherheitsschalter mit Kunststoffgehäuse Safety Switches with Plastic Housing Interruptores de seguridad con carcasa plástica Interrupteurs de sécurité avec boîtier plastique 塑料壳体的安全开关

	Doc. no.	Version	Language	Download
Sicherheitsschalter mit Kunststoffgehäuse	096955	11-03/18		 6.6 MB
Interrupteurs de sécurité avec boîtier plastique	100677	11-03/18		 6.6 MB
Interruptores de seguridad con carcasa plástica	104855	11-03/18		 6.6 MB
Bezpečnostní spínače s plastovým pouzdrém	121649	11-03/18		 6.6 MB
Safety Switches with Plastic Housing	096956	11-03/18		 6.6 MB
塑料壳体的安全开关	116243	11-03/18		 6.2 MB

### Sicherheitsschalter mit Metallgehäuse Safety Switches with Metal Housing Bezpečnostní spínače s kovovým pouzdrém Interrupteurs de sécurité avec boîtier métallique 金属壳体的安全开关 Interruptores de seguridad con carcasa metálica





Doc. no.	Version	Language	Download
----------	---------	----------	----------



Sicherheitsschalter mit Metallgehäuse	100319	11-03/18		 7.9 MB
Interrupteurs de sécurité avec boîtier métallique	100676	11-03/18		 7.9 MB
Interruptores de seguridad con carcasa metálica	104856	11-03/18		 14.0 MB
Safety Switches with Metal Housing	100369	11-03/18		 7.9 MB
Bezpečnostní spínače s kovovým pouzdem	121650	11-03/18		 7.9 MB
金属壳体 的安全开关	102453	11-03/18		 8.2 MB

## Declaration of conformity

EU-Konformitätserklärung

	Doc. no.	Version	Language	Download
EU-Konformitätserklärung	2093482	13-06/16		 0.3 MB
Declaración UE de conformidad				
Déclaration UE de conformité				
Dichiarazione di conformità				
EU declaration of conformity			