

ITEM 097747 AE-B-A1-02,0-F-097747

Description	Technical data	Accessories	Downloads
-------------	----------------	-------------	-----------



Features

- › Can be used as escape release or emergency unlocking
- › automatic return
- › Sheath length 2 m (rope length 6 m)

Flexible routing of the pull wire permits release of the guard locking in inaccessible installation situations.

- › Usage as emergency unlocking if the safety switch is mounted in an inaccessible position
- › Usage as escape release for unlocking the guard locking from the danger area
- › Can be retrofitted to all series CTP/TP/STP/STA safety switches

Mechanical values and environment

Sheath length	Outer	2 m
Housing material		Plastic

Rope length	Cabling rope	6 m
-------------	--------------	-----

Miscellaneous

Detent mechanism	No [1]
------------------	--------

[1] Resetting

Dimension drawing

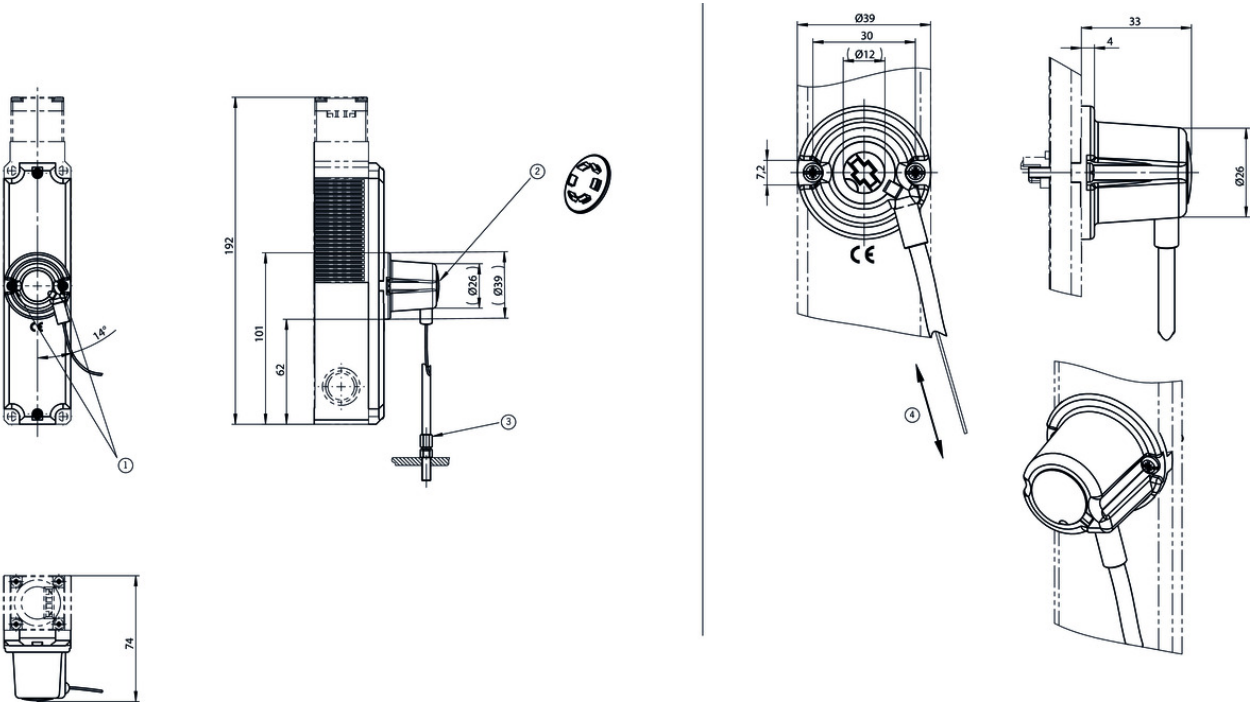

Legende

- 1 Mounting by means of the screw included, length: 17mm!
- 2 Cover
- 3 Adjusting screw M5x17.5 for fixing the hose cable (included).
- 4 A stroke of min. 17mm is necessary for reliable release.

Function expansion

✓ Handle for wire front release



099795 AY-HDL-099795
 ✓ Features

› Suitable for all wire front releases



124204 AY-HDL-124204

✓ Features

› Suitable for all wire front releases

Instructions

✓ Montageanleitung Bowdenzugentriegelung

	Doc. no.	Version	Language	Download
Montageanleitung Bowdenzugentriegelung Assembly Instructions Wire Front Release (Bowden)	125443	01-07/15		0.6 MB

Catalogs

✓ Transpondercodierte Sicherheitsschalter - Verriegelungseinrichtungen und Zuhaltungen
Transponder-coded safety switches - Interlocking devices and guard locking devices
Interruptores de seguridad con codificación por transponder - Dispositivos de enclavamiento y bloqueos
Interrupteurs de sécurité à codage par transpondeur - Dispositifs de verrouillage et interverrouillages













	Doc. no.	Version	Language	Download
Transpondercodierte Sicherheitsschalter - Verriegelungseinrichtungen und Zuhaltungen	127594	02-01/18		5.2 MB
Interrupteurs de sécurité à codage par transpondeur - Dispositifs de verrouillage et interverrouillages	137558	02-01/18		5.2 MB
Interruptores de seguridad con codificación por transponder - Dispositivos de enclavamiento y bloqueos	137560	02-01/18		5.2 MB
Transponder-coded safety switches - Interlocking devices and guard locking devices	127595	02-01/18		5.1 MB

✓ Bezpečnostní spínače s plastovým pouzdrém Sicherheitsschalter mit Kunststoffgehäuse Safety
Switches with Plastic Housing Interruptores de seguridad con carcasa plástica Interrupteurs de
sécurité avec boîtier plastique 塑料壳体 的安全开关

	Doc. no.	Version	Language	Download
Sicherheitsschalter mit Kunststoffgehäuse	096955	11-03/18		6.6 MB
Interrupteurs de sécurité avec boîtier plastique	100677	11-03/18		6.6 MB
Interruptores de seguridad con carcasa plástica	104855	11-03/18		6.6 MB
Bezpečnostní spínače s plastovým pouzdrém	121649	11-03/18		6.6 MB
Safety Switches with Plastic Housing	096956	11-03/18		6.6 MB
塑料壳体 的安全开关	116243	11-03/18		6.2 MB

✓ Sicherheitsschalter mit Metallgehäuse Safety Switches with Metal Housing Bezpečnostní spínače
s kovovým pouzdrém Interrupteurs de sécurité avec boîtier métallique 金属壳体 的安全开关

Interruptores de seguridad con carcasa metálica

	Doc. no.	Version	Language	Download
Sicherheitsschalter mit Metallgehäuse	100319	11-03/18		 7.9 MB
Interrupteurs de sécurité avec boîtier métallique	100676	11-03/18		 7.9 MB
Interruptores de seguridad con carcasa metálica	104856	11-03/18		 14.0 MB
Safety Switches with Metal Housing	100369	11-03/18		 7.9 MB
Bezpečnostní spínače s kovovým pouzdem	121650	11-03/18		 7.9 MB
金属壳体 的安全开关	102453	11-03/18		 8.2 MB