

ITEM 088257 TP4-4141A024SEM4AS1

Description	Technical data	Accessories	Downloads
-------------	----------------	-------------	-----------



Features

- › Auxiliary release on the front
- › Increased horizontal overtravel
- › Optional without guard lock monitoring

Guard locking types

- TP3** Closed-circuit current principle, guard locking by spring force. Release by control of AS-i output 0.
- TP4** Open-circuit current principle, guard locking by control of AS-i output 0. Release by spring force.

Control of the guard locking solenoid

The guard locking solenoid is controlled by the control system via AS-Interface bus bit D0. In addition the 24V connection can be switched safely.

AS-Interface inputs, version AS1

- D0, D1** Door monitoring contact SK
D2, D3 Solenoid monitoring contact ÜK

AS-Interface inputs, version AS1

D0, D1 Door monitoring contact SK 1

D2, D3 Door monitoring contact SK 2

Evaluation is performed via a safety monitor.

AS-Interface outputs

D0 Guard locking solenoid

D1 Red LED

D2 Green LED

LED function display

- › The Power LED indicates the operating voltage on the bus.
- › The Fault LED indicates if a fault has been detected on the AS-Interface bus.
- › The green and the red LEDs can be controlled as required by the control system via the bus using bits D1 and D2.

Auxiliary release

Is used for releasing the guard locking with the aid of a tool. To protect against tampering, the auxiliary release is sealed with sealing lacquer.

Approvals



Mechanical values and environment

Housing material	Reinforced thermoplastic
Weight	Net 0,5 kg
Ambient temperature	-20 ... 55 °C
Degree of protection	IP67
Mechanical life	1 x 10 ⁶
Contact material	Silver alloy, gold flashed
Switching principle	Slow-action switching contact
Installation position	Any
Number of door position positively driven contacts	
According to As-i Safety at Work	1 D0,D1 [1]
Number of guard lock monitoring positively driven contacts	
According to As-i Safety at Work	1 D2,D3 [2]
Connection	
	1 x Plug connector M12 [3]

Approach speed	max. 20 m/min
Actuation frequency	1200 1/h
Guard locking principle	Open-circuit current principle
Retention force	10 N
Extraction force	20 N
Actuating force	10 N

Electrical connection ratings

ASi voltage	22,5 ... 30 V 31,6 V
ASi operating current	max.45 mA
ASi auxiliary voltage	
IEC 60742, PELV	24 V -15% ... +10%
ASi auxiliary current	300 mA
Solenoid duty cycle	100 %
ASi slave type	
According to ASI specification 2.1	EA code: 7
According to ASI specification 2.1	ID code: B
ASi data in	
According to ASI safety at work	D0,D1,D2,D3 [4]
ASi data out	
Guard locking solenoid	D0 [5]
LED red	D1 [6]
LED green	D2 [7]
ASi LED	
LED green	Power [8]
LED red	Fault [9]

Reliability values acc. to EN ISO 13849-1

B10 _D	3×10^6
------------------	-----------------

in combination with Actuator BETAETIGER-P-GT

Mechanical values and environment

Overtravel		
	Horizontal	2 mm
	Vertical	1,5 mm
Insertion depth		
	Horizontal	28 mm
	Vertical	29,5 mm

in combination with Actuator BETAETIGER-P-GNT

Mechanical values and environment

Overtravel	Horizontal	7 mm
Insertion depth	Horizontal	28 mm

[1] 1 = Door closed

[2] 1 = Locked

[3] 4-pin

[4] See positively driven NC contact

[5] 1 = Solenoid energized

[6, 7] 1 = LED on

[8] ASI voltage is present

[9] Offline phase or address 0

Dimension drawing

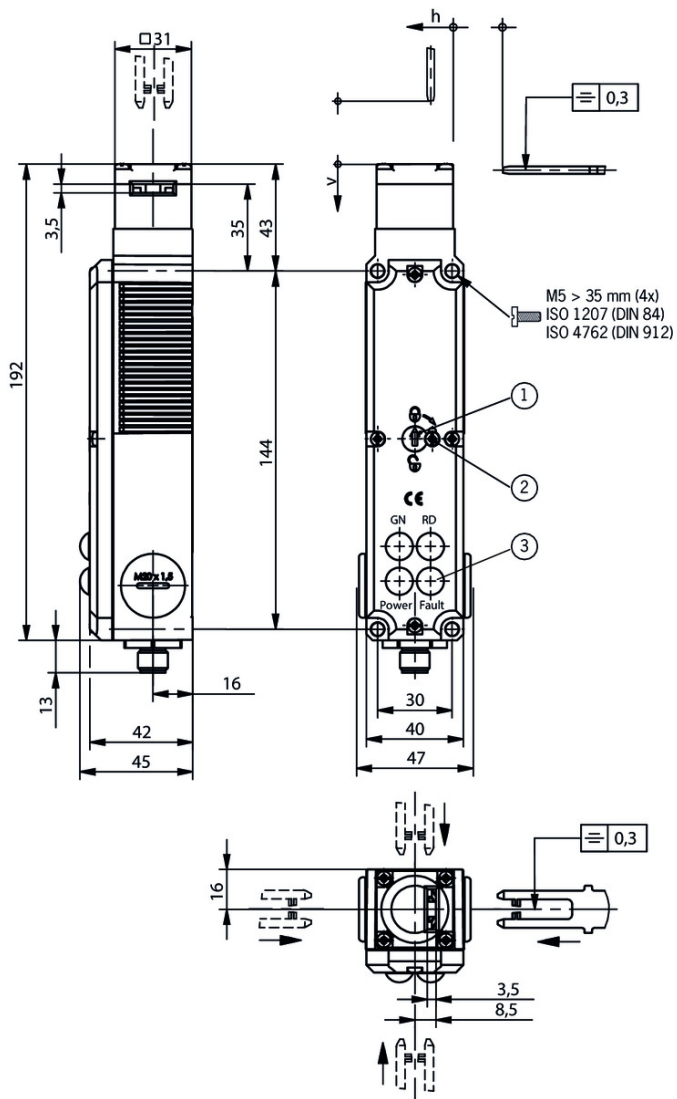

Legende

- 1 Auxiliary release
- 2 Locking screw
- 3 LED indicator

Connector assignment

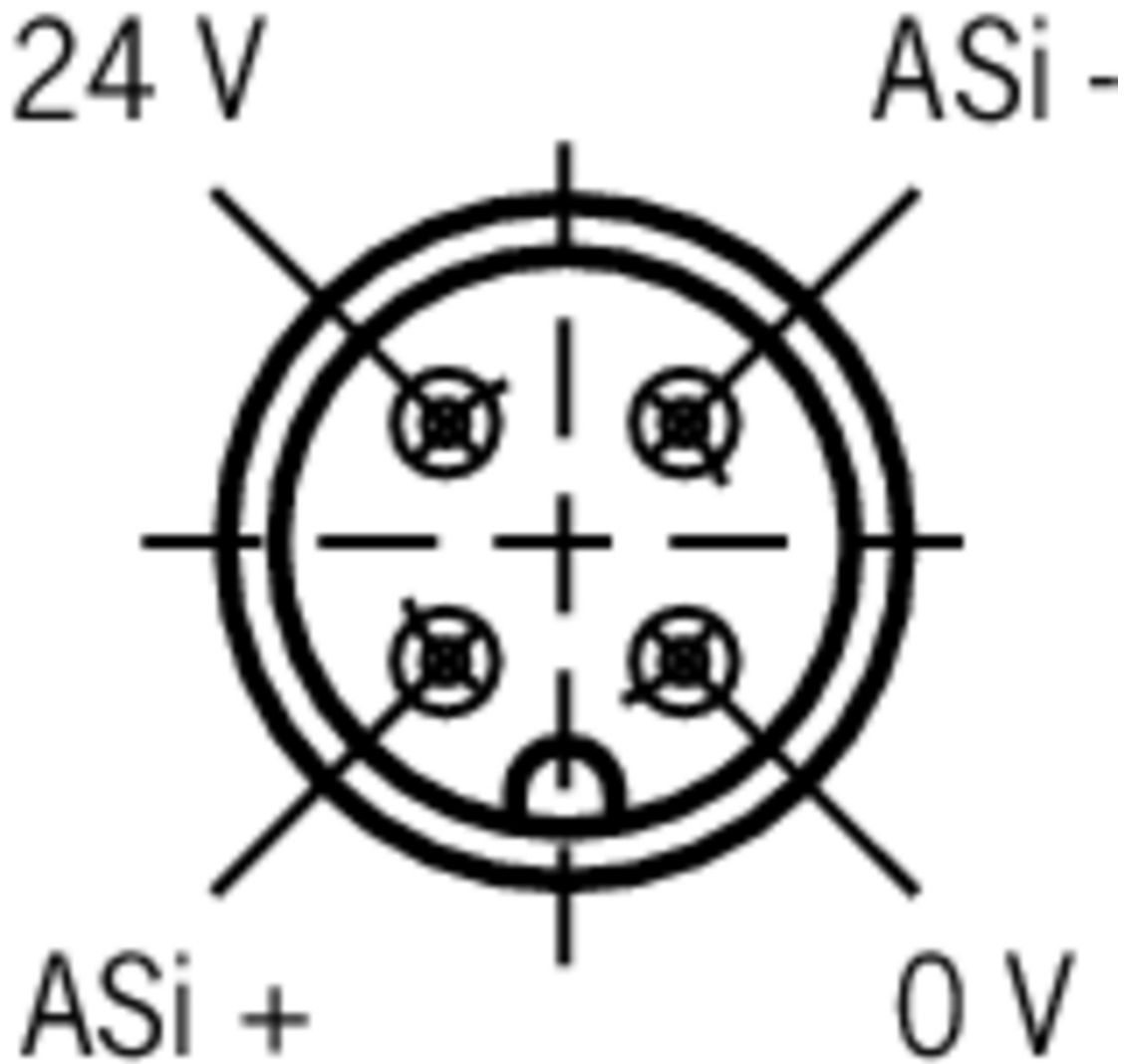

Legende

View of connection side

Actuator

Actuators for safety switches NP/GP/TP



059226 BETAETIGER-P-G

Features

- › Actuators made of stainless steel
- › Two stainless safety screws per actuator



070046 BETAETIGER-P-GT

Features

- › Actuators made of stainless steel
- › Two stainless safety screws per actuator

- › Actuators with rubber bushings
-

▼ Bent actuator for safety switches NP/GP/TP



059227 BETAETIGER-P-W

▼ Features

- › Actuators made of stainless steel
 - › Two stainless safety screws per actuator
-



070038 BETAETIGER-P-WT

▼ Features

- › Actuators made of stainless steel
 - › Two stainless safety screws per actuator
 - › Actuators with rubber bushings
-

▼ Actuators for safety switches NP/GP/TP, increased overtravel



074570 BETAETIGER-P-GN

▼ Features

- › Actuators made of stainless steel
 - › Two stainless safety screws per actuator
-



074576 BETAETIGER-P-GNT

▼ Features

- › Actuators made of stainless steel
 - › Two stainless safety screws per actuator
 - › Actuators with rubber bushings
-

▼ Bent actuator for safety switches NP/GP/TP, increased overtravel



074571 BETAETIGER-P-WN

▼ Features

- › Actuators made of stainless steel
 - › Two stainless safety screws per actuator
-



074577 BETAETIGER-P-WNT

▼ Features

- › Actuators made of stainless steel
 - › Two stainless safety screws per actuator
 - › Actuators with rubber bushings
-

▼ Hinged actuator top/bottom for safety switches NP/GP/TP



070050 RADIUSBETAETIGER-P-OU

▼ Features

- › Actuators made of stainless steel
 - › Two stainless safety screws per actuator
 - › For doors hinged at top and bottom
-

- ▼ Hinged actuator left/right for safety switches NP/GP/TP



059440 RADIUSBETAETIGER-P-LR

▼ Features

- › Actuators made of stainless steel
- › Two stainless safety screws per actuator
- › For doors hinged on right and left

- ▼ Hinged actuator top/bottom for safety switches NP/GP/TP, increased overtravel



074572 RADIUSBETAETIGER-P-OUN

▼ Features

- › Actuators made of stainless steel
- › Two stainless safety screws per actuator
- › For doors hinged at top and bottom

- ▼ Hinged actuator left/right for safety switches NP/GP/TP, increased overtravel



074573 RADIUSBETAETIGER-P-LRN

▼ Features

- › Actuators made of stainless steel
- › Two stainless safety screws per actuator
- › For doors hinged on right and left

Function expansion

- ▼ Lock for auxiliary release for safety switches CTP/TP/STP



084177 SCHLOSS TP VERSCHIEDENSCHLIESSEND

▼ Features

- › Lock unique locking
- › Key removable in “unlocked” and “locked” positions



086236 SCHLOSS TP GLEICHSCHLIESSEND

▼ Features

- › Identical locking
- › Key removable in “unlocked” and “locked” positions



109212 SCHLOSS TP GLEICHSCHLIESSEND C2293

▼ Features

- › Identical locking
- › Key can be removed only in “locked” position

- ▼ Lockout bar NP/GP/TP



096105 SPERREINSATZ TP

▼ Features

- › Prevents unintentional closing of the door
- › Can be secured with padlocks

-
- ▼ Latch spring for increased retention force

076501 RASTFEDER NP/TP

- ▼ Insertion funnel for safety switches NP..A/GP/TP..A



086237 EINFUEHRTRICHTER-P

- ▼ Emergency unlocking for safety switches CTP/TP/STP



099877 NOTENTSPERRUNG TP/STP

- ▼ Release with automatic reset for safety switches CTP/TP/STP



103110 ENTRIEGELUNG RUECKSTELLEND TP/STP

- ▼ Wire front release



096230 AE-B-A1-02,0-096230

▼ Features

- › Can be used as escape release or emergency unlocking
 - › No automatic return
 - › Sheath length 2 m (rope length 6 m)
-



098313 AE-B-A1-03,0-098313

▼ Features

- › Can be used as escape release or emergency unlocking
 - › No automatic return
 - › Sheath length 3 m (rope length 6 m)
-



098314 AE-B-A1-04,0-098314

▼ Features

- › Can be used as escape release or emergency unlocking
 - › No automatic return
 - › Sheath length 4 m (rope length 6 m)
-



097747 AE-B-A1-02,0-F-097747

▼ Features

- › Can be used as escape release or emergency unlocking
 - › automatic return
 - › Sheath length 2 m (rope length 6 m)
-



125582 AE-B-A1-06,0-125582

▼ Features

- › Can be used as escape release or emergency unlocking

- › No automatic return
- › Rope length 6 m (without sheath)



124770 AE-B-A1-06,0-F-124770

▼ Features

- › Can be used as escape release or emergency unlocking
- › automatic return
- › Rope length 6 m (without sheath)



111233 AE-B-A1-03,0-F-111233

▼ Features

- › Can be used as escape release or emergency unlocking
- › automatic return
- › Sheath length 3 m (rope length 6 m)

▼ Handle for wire front release



099795 AY-HDL-099795

▼ Features

- › Suitable for all wire front releases

Spare parts

▼ Replacement key for mechanical key release



099434 ERSATZSCHLUESSEL GLEICHSCHL.0354

Mounting accessories

▼ Mounting plates EMP-B1 for actuators for safety switches CTP, TP...A, STA, STP, TX and TZ



093457 EMP-B1

▼ Mounting plates EMP-B2 for actuators for safety switches CTP, TP...A, STA, STP, TX and TZ



093458 EMP-B2

▼ Mounting plates EMP-SB for safety switches CTP, TP...A, STA, STP and TX



093456 EMP-SB

▼ Features

- › For vertical and horizontal mounting of safety switches TP...A, STA, STP and TX

Bolt

- ▼ Bolt 0 NP/TP for safety switches NP, GP and TP



073535 RIEGEL 0 NP/TP OHNE RASTUNG

▼ Features

- › Steel bolt
 - › For doors hinged on the left or right
 - › Can be locked in open position with padlocks
 - › Actuator included
-

- ▼ Bolt 1 NP/TP for safety switches NP, GP and TP



073536 RIEGEL 1 NP/TP 1X RASTUNG ZU

▼ Features

- › Steel bolt
 - › For doors hinged on the left or right
 - › Can be locked in open position with padlocks
 - › Actuator included
 - › Detent mechanism closed position
-

- ▼ Bolt TP/GP... for safety switches GP and TP



084430 RIEGEL TP-A

▼ Features

- › Steel bolt
 - › For doors hinged on the right
 - › Can be locked in open position with padlocks
 - › Actuator included
-



084432 RIEGEL TP-C

▼ Features

- › Steel bolt
 - › For doors hinged on the left
 - › Can be locked in open position with padlocks
 - › Actuator included
-

- ▼ Bolt TP-GFK for safety switches TP and GP



096616 RIEGEL TP-GFK

▼ Features

- › Fiber glass reinforced plastic bolt
 - › For doors hinged on the left or right
 - › Can be locked in open position with padlocks
 - › Actuator included
-

- ▼ Bolt BTC-T/GP... without escape release for safety switches GP and TP



106301 BTC-T/GP-S-TH-00-X

▼ Features

- › Aluminum bolt

- › For doors hinged on the left or right
- › Can be locked in open position with padlocks
- › Actuator included

Connection material

- ▼ Bus coupling module with plug connector M12, 5-pin



105756 BCM-A-P2-SEM4-1

- ▼ Features

- › Conversion from M12 to ribbon cable
- › Very compact design
- › Easy handling

Instructions

- ▼ Betriebsanleitung Sicherheitsschalter TP...AS1

	Doc. no.	Version	Language	Download
Betriebsanleitung Sicherheitsschalter TP...AS1 Operating Instructions Safety Switches TP...AS1	089717	08-08/15		1.7 MB

Catalogs









- ▼ Sicherheitsschalter mit AS-Interface Safety Switches with AS-Interface Interrupteurs de sécurité avec AS-Interface

	Doc. no.	Version	Language	Download
Sicherheitsschalter mit AS-Interface	092164	11-04/17		2.3 MB
Interrupteurs de sécurité avec AS-Interface	112564	11-04/17		2.3 MB
Safety Switches with AS-Interface	092332	11-04/17		2.3 MB

Declaration of conformity

- ▼ EU prohlášení o shodě

	Doc. no.	Version	Language	Download
EU-Konformitätserklärung Declaración UE de conformidad Déclaration UE de conformité Dichiarazione di conformità EU declaration of conformity	2077153	25-02/17		0.3 MB

EU prohlášení o shodě	2077153	25-02/17		 0.5 MB
EU-overensstemmelseserklæring				
Δήλωση συμμόρφωσης της ΕΕ				
EU-vaatimustenmukaisuusvakuutus				
EU-típusbizonyítvány				
EU-conformiteitsverklaring				
Deklaracja zgodności UE				
Declaração de Conformidade UE				
Declarația de conformitate UE				
EÚ vyhlásenie o zhode				

CAD data

CAD data for this item on TraceParts