

ITEM 124713 ES-XN4E-BL413MFRH

Description	Technical data	Accessories	Downloads
-------------	----------------	-------------	-----------



Features

- › Button head red 44 mm ø
- › Contact block monitoring
- › Can be locked using padlock
- › Reset by turning

Switching element

- › 3 NC ⊕ + 1 NO

Approvals



Mechanical values and environment

Material

Button	Fiber glass reinforced thermoplastic
Housing	Polycarbonate
Ambient temperature	-25 ... 60 °C
Degree of protection	IP20
Mechanical life	0,25 x 10 ⁶
Contact material	Silver alloy, gold flashed
Mounting method	IEC 947-5-1 D30
Number of positively driven contacts	3
Number of NO contacts	1
Connection	Screw terminal

Electrical connection ratings

Rated thermal current I _{th}	1 A
Utilization category according to EN 60947-5-1	
AC-15	1.5 A 250 V
DC-13	1A 30V
AC-14	0.3 A 250 V
Rated insulation voltage U _i	250 V
Switching current	
Min. at 24V	10 mA

Miscellaneous

Additional feature	
	Button head Ø 44 mm
	Reset by turning
	Can be locked using padlock
	Contact block monitoring
Color	
Actuating button	Red
Bottom part	Yellow

Reliability values acc. to EN ISO 13849-1

B10 _D	0,1 x 10 ⁶
------------------	-----------------------

Dimension drawing

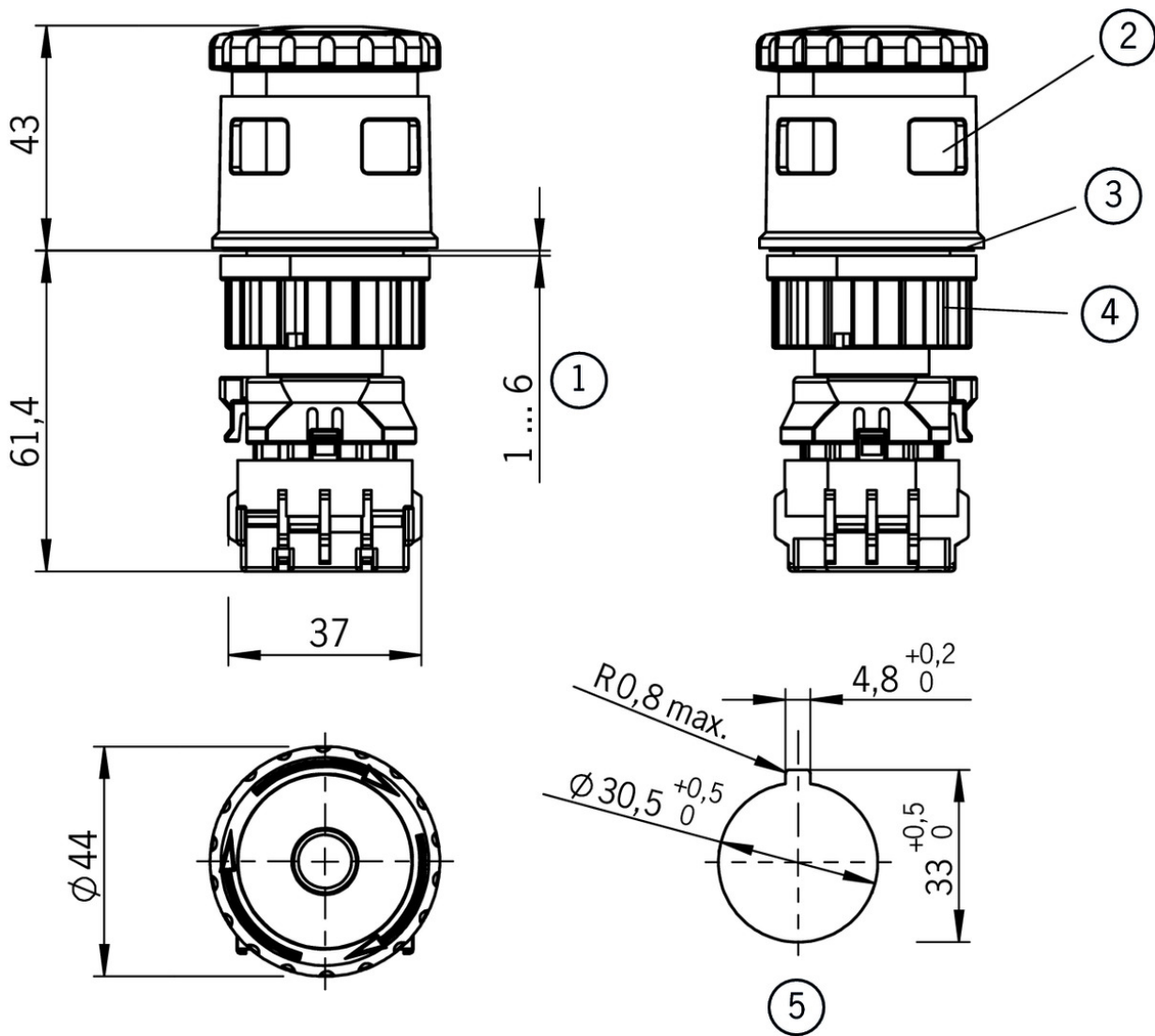

Legende

- 1 Front panel thickness
- 2 Opening for padlock
- 3 Seal
- 4 Screw ring
- 5 Panel cut-out

Switching functions

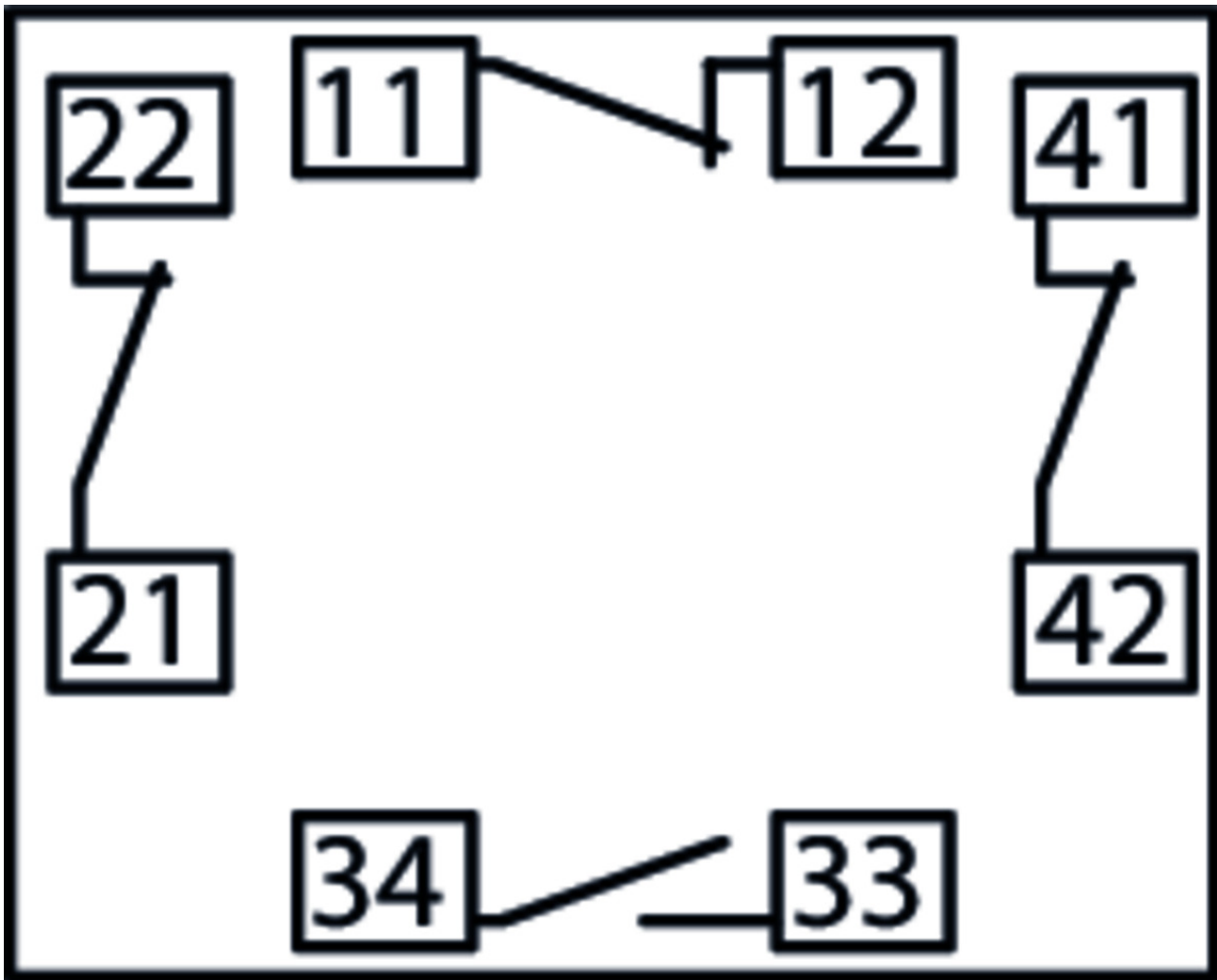

Mounting accessories

Sign for emergency stop ES-XN



106341 ES-HNAV-27

Features

- › Emergency stop plate for 40 mm buttons on ES-XN devices with text: Emergency Stop.

Key for emergency stop ES-XN



106338 ES-XN9Z-T1

Features

- › Key for fastening the ring screw on ES-XN... devices









Instructions

▼ Betriebsanleitung Not-Aus-Schalter ES-XW/XN

	Doc. no.	Version	Language	Download
Betriebsanleitung Not-Aus-Schalter ES-XW/XN Operating Instructions Emergency Stop Switch ES-XW/XN	2105026	11-06/17	 	 1.3 MB





Catalogs

▼ Not-Halt-Geräte/Seilzugschalter Emergency Stop Devices/Rope Pull Switches Dispositifs d'arrêt d'urgence/interrupteurs à câble Dispositivos de parada de emergencia / Interruptores de accionamiento por cable

	Doc. no.	Version	Language	Download
Not-Halt-Geräte/Seilzugschalter	106210	06-06/16		 1.9 MB
Dispositifs d'arrêt d'urgence/interrupteurs à câble	116529	06-06/16		 1.9 MB
Dispositivos de parada de emergencia / Interruptores de accionamiento por cable	116530	06-06/16		 1.9 MB
Emergency Stop Devices/Rope Pull Switches	116448	06-06/16		 1.9 MB

Declaration of conformity

▼ EU-Konformitätserklärung

	Doc. no.	Version	Language	Download
EU-Konformitätserklärung EU declaration of conformity Declaración UE de conformidad Déclaration UE de conformité Dichiarazione di conformità	2105755	08-03/17	    	 0.2 MB