

ITEM 123625 AE-L-C40-123625

Description	Technical data	Accessories	Downloads
-------------	----------------	-------------	-----------

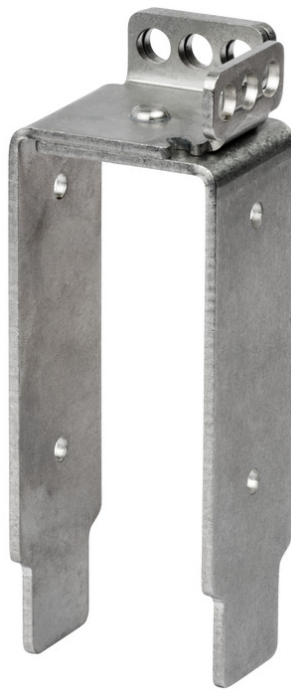

Features

- › Prevents unintentional closing of the door
- › Can be secured with padlocks

Can be mounted on switch CEM. Removal can be prevented using a commercially available padlock (max. 3 ea.).

Components included in the set

Supplied accessories

LOCKOUT MECHANISM CEM-C40

Mechanical values and environment

Material	STAINLESS STEEL
Weight	
	Net 0,23 kg
Pin diameter	4 ... 7 mm

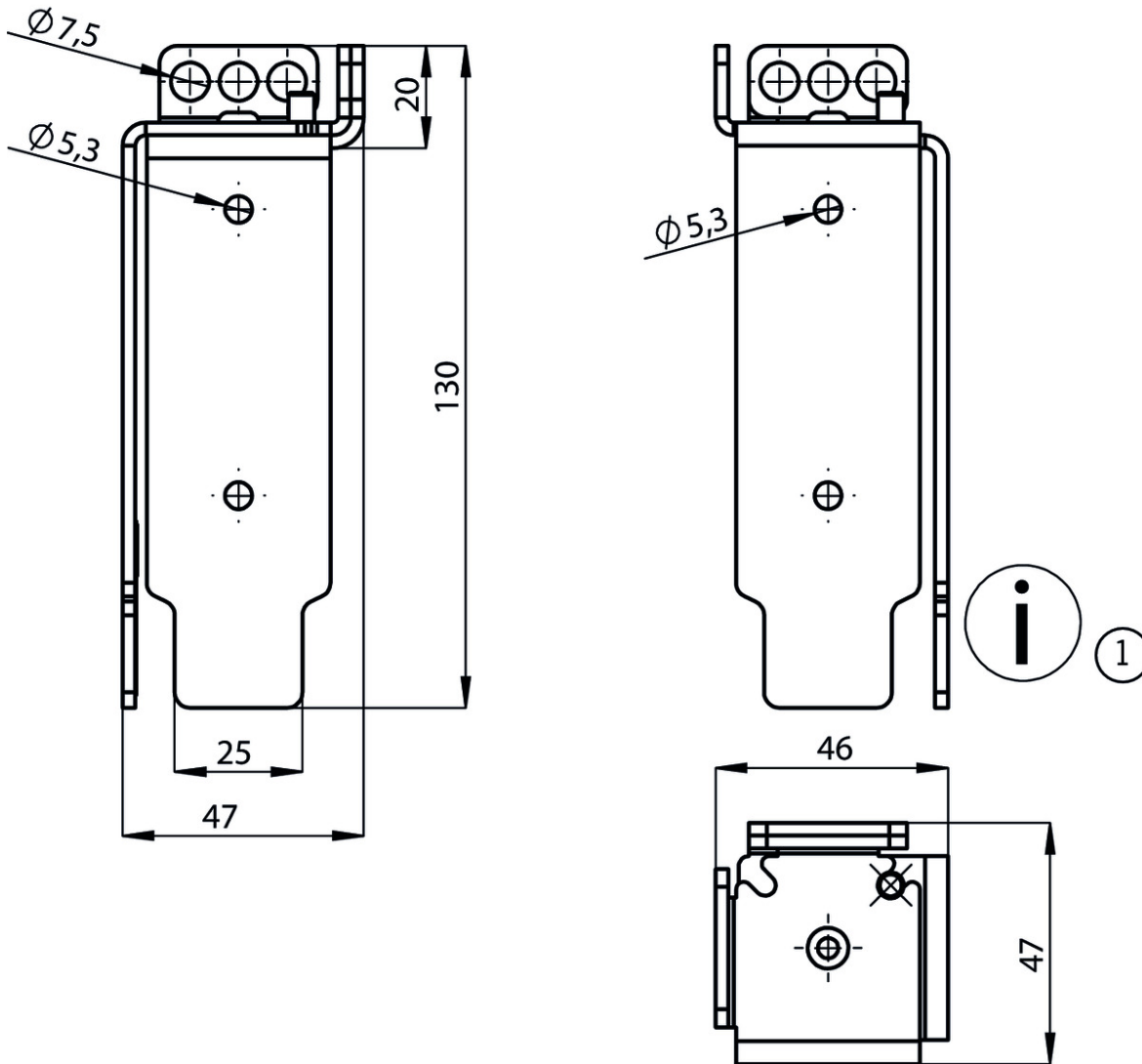





Dimension drawing**Legende**

1 The lockout bar is not a safety function.

Catalogs

- ✓ Transpondercodierte Sicherheitsschalter - Verriegelungseinrichtungen und Zuhaltungen
Transponder-coded safety switches - Interlocking devices and guard locking devices
Interruptores de seguridad con codificación por transponder - Dispositivos de enclavamiento y

bloqueos Interrupteurs de sécurité à codage par transpondeur - Dispositifs de verrouillage et interverrouillages

	Doc. no.	Version	Language	Download
Transpondercodierte Sicherheitsschalter - Verriegelungseinrichtungen und Zuhaltungen	127594	02-01/18		 5.2 MB
Interrupteurs de sécurité à codage par transpondeur - Dispositifs de verrouillage et interverrouillages	137558	02-01/18		 5.2 MB
Interruptores de seguridad con codificación por transponder - Dispositivos de enclavamiento y bloqueos	137560	02-01/18		 5.2 MB
Transponder-coded safety switches - Interlocking devices and guard locking devices	127595	02-01/18		 5.1 MB