

ITEM 123440 C-M12M05-05X034PV05,0-MA-123440

Description	Technical data	Accessories	Downloads
-------------	----------------	-------------	-----------

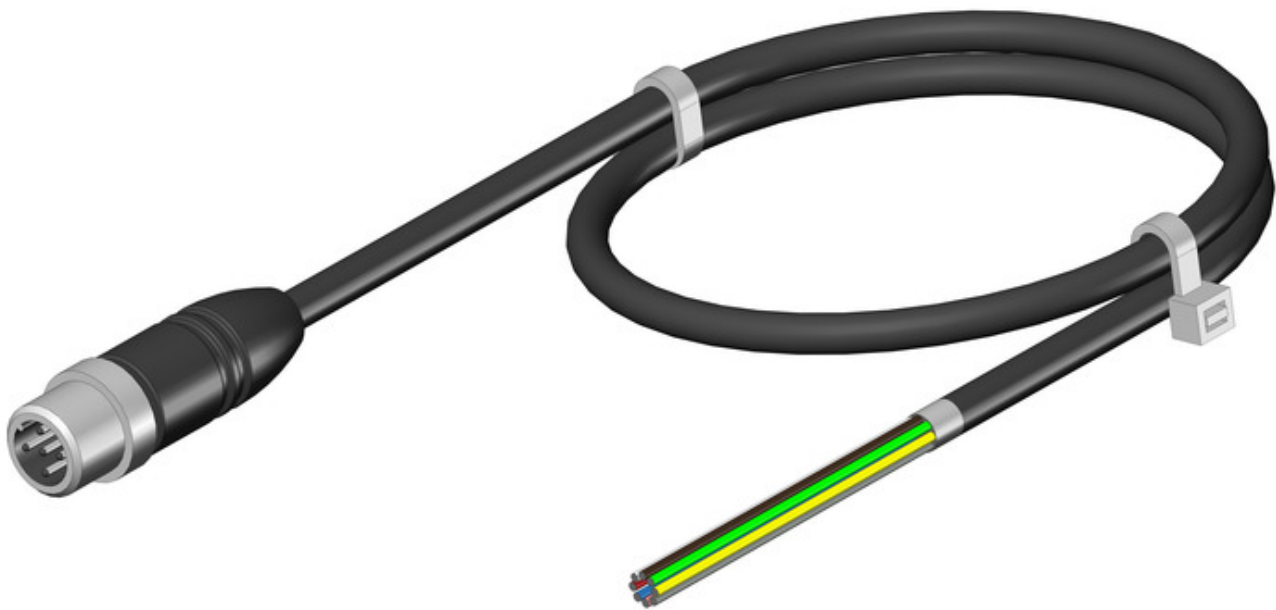

Features

- › 5-pin M12 male plug, straight
- › PVC cable
- › Cable length 5m
- › With flying lead

Mechanical values and environment

Sheath material	PVC
Conductor insulation material	PVC
Conductor material	Cu flexible wire bare
Fire behavior	Flame retardant according to UL-Style 2464
Drag chain suitability	No
UV resistance	Moderately UV-resistant
Ambient temperature	
	static -25 ... +80 °C
	Dynamic -5 ... +80 °C
Number of conductors	5
Type of cable	straight

Cable length	5 m
Cable diameter	
Approx.	5,9 mm
Conductor cross-section	0.34 mm ²
Conductor identification	Color code
Sheath color	Black
Bending radius	
static	5 x cable diameter
Dynamic	15 x cable diameter
Connection 1	
Degree of protection	IP67 [1]
Plug lock material	CuZn, nickel-plated
Insertion cycles	100
Connection	Plug connectors M12x1
Connection type	Plug
Cable outlet	straight
Number of pins	5
Plug lock	Screw connection
Plug housing material	TPU
Connection 2	
Conductor end	Sheath stripped
Connection	Flying lead

Electrical connection ratings

Nominal current	
At 40° C	4 A
Rated voltage	60 V
Overtoltage category according to IEC EN 60664-1	III
Rated surge voltage according to IEC 60664-1	1500 V
Specific cable resistance	58 Ω/km
Specific inductance	0,53 mH/km
Specific capacitance	100 nF/km
Connection 1	
Degree of contamination according to EN 60664-1	3

[1] In the inserted state

Dimension drawing

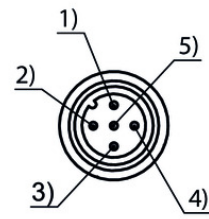
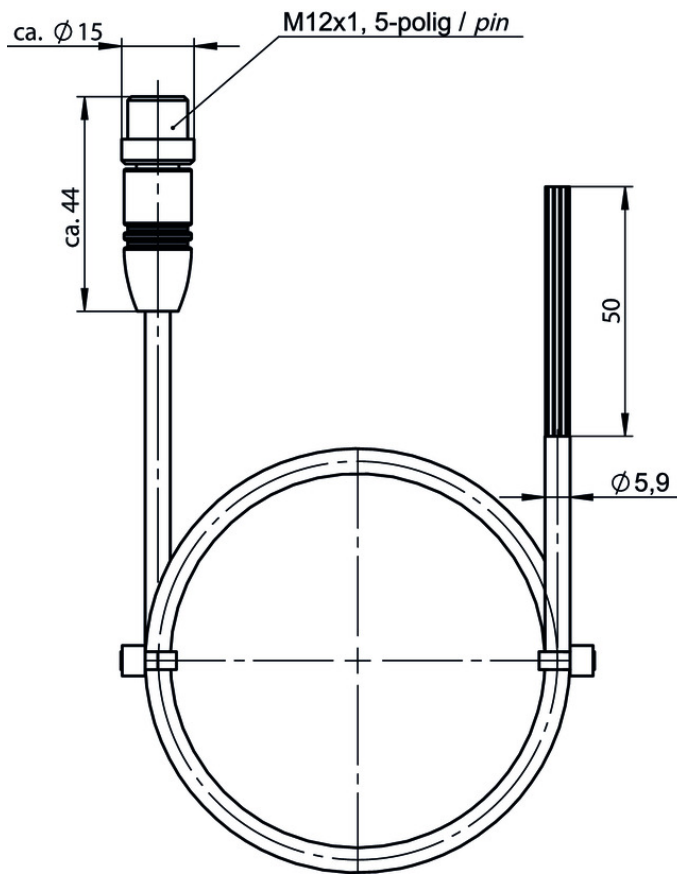

- PIN 1 = BN
- PIN 2 = WH
- PIN 3 = BU
- PIN 4 = BK
- PIN 5 = GY