

ITEM 094169 NZ1RS-3131-M-EX

Description	Technical data	Accessories	Downloads
-------------	----------------	-------------	-----------



Features

- › ATEX version
- › Version C according to EN 50041(steel roller ø 12 mm)
- › Suitable for usage in zone 2 and 22 (gases and dusts)
- › Cable entry M20 x 1.5

Switching element

3131H Slow-action switching contact 2 NC \rightarrow + 2 NO

Approvals



Mechanical values and environment

Housing material	Anodized die-cast alloy
------------------	-------------------------

Weight	Approx.	0,35 kg
Ambient temperature		-20 ... 75 °C
Degree of protection		IP67
Mechanical life		30 x 10 ⁶
Contact material		Silver alloy, gold flashed
Switching principle		Slow-action switching contact
Installation position		Any
Number of door position positively driven contacts		2
Number of NO contacts		2
Connection	1 x	Cable gland M20 x 1.5
Clamping range for cable		6,5 ... 12 mm
Approach speed	max.	0,1 ... 20 m/min
Actuating element	Plain bearing metal	Roller plunger
Roller diameter		12 mm
Actuating force	At 20°C	30 N

Electrical connection ratings

Rated thermal current I _{th}		4 A
Utilization category according to EN 60947-5-1	AC-15	4A 50V
	DC-13	4A 24V
Short circuit protection according to IEC 60269-1	(Fuse)	4A gG
Rated insulation voltage U _i		50 V
Rated impulse withstand voltage U _{imp}		2,5 kV
Switching voltage		12 V
Switching current	Min. at DC 24V	1 mA
Degree of contamination (external, according to EN 60947-1)		3 (industry)
Connection cross-section		0,34 ... 1,5 mm ²

Miscellaneous

Explosion protection	incl. cable gland	II3G Ex nR IIB T5 Gc X / II3D Ex tc IIIC T100°C Dc
----------------------	-------------------	--

Reliability values acc. to EN ISO 13849-1

Dimension drawing

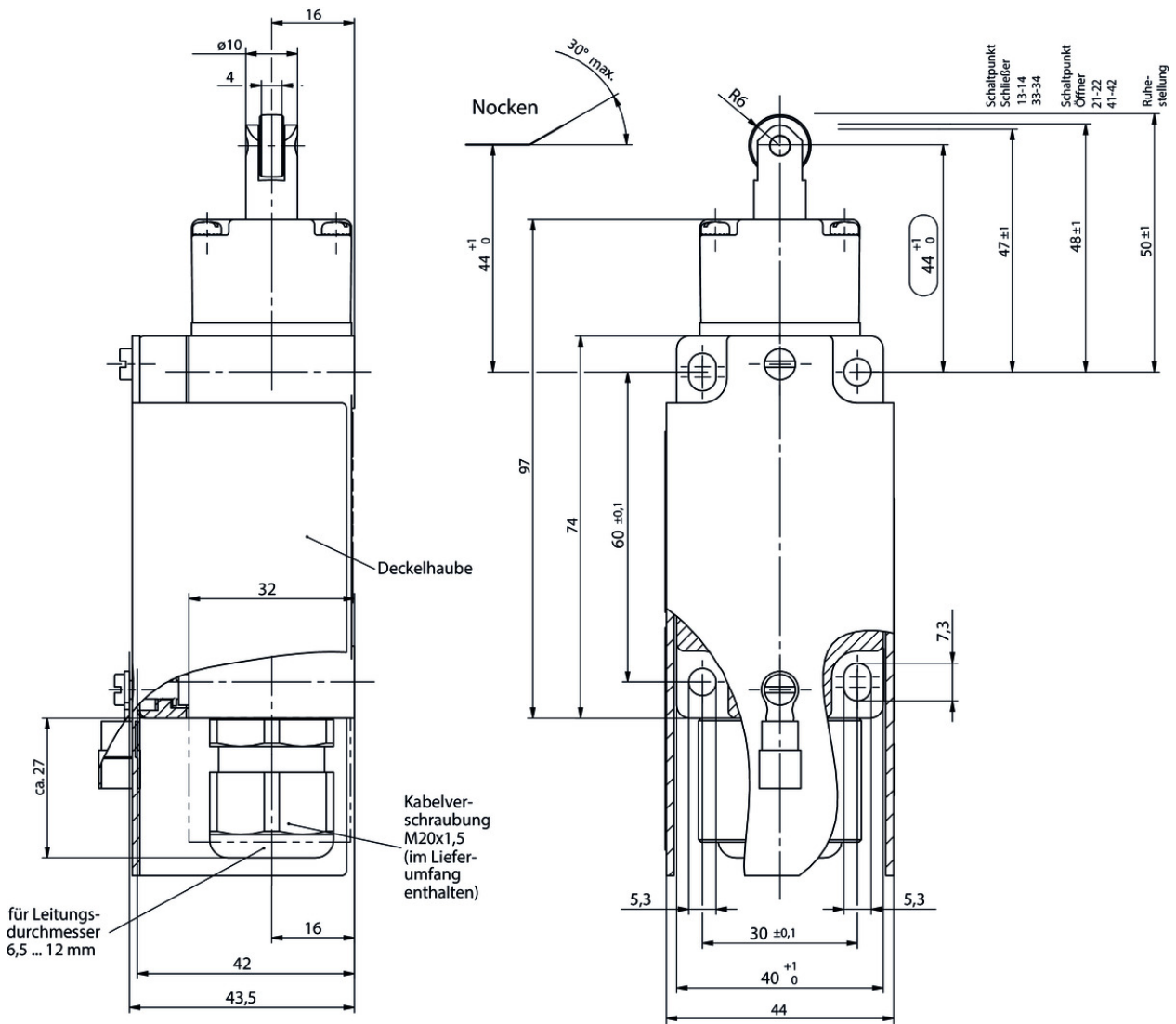

3131H

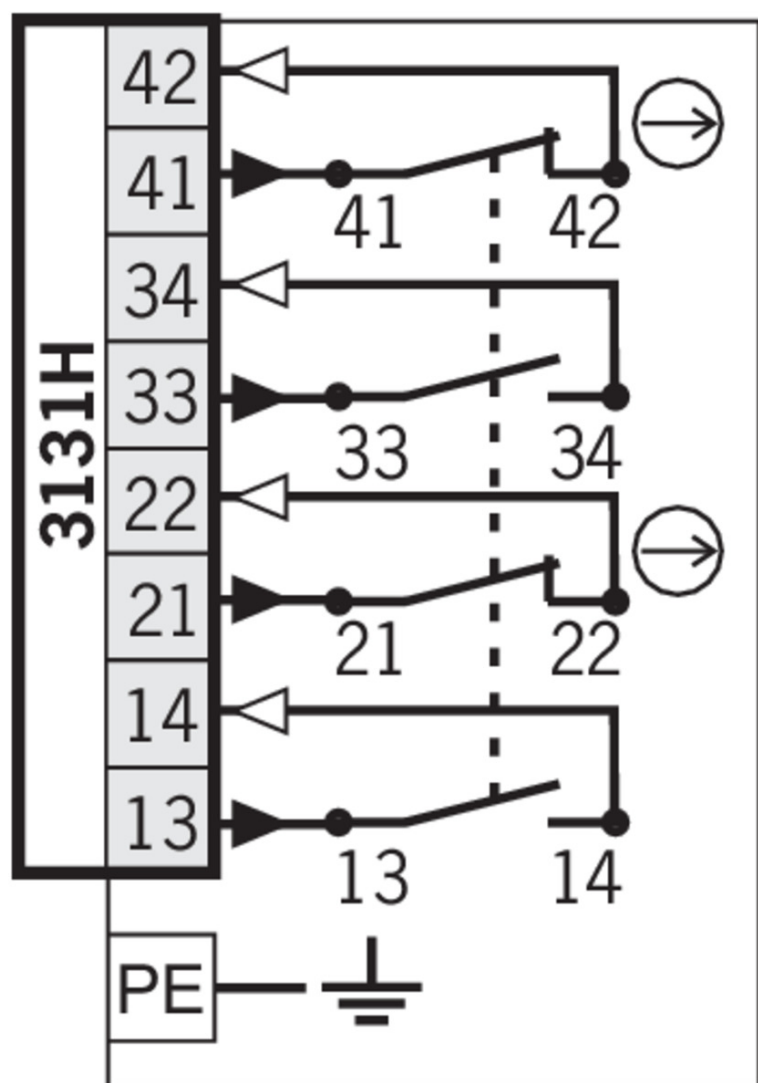

Travel diagram

**NZ.RS
NZ...RG**



3131H

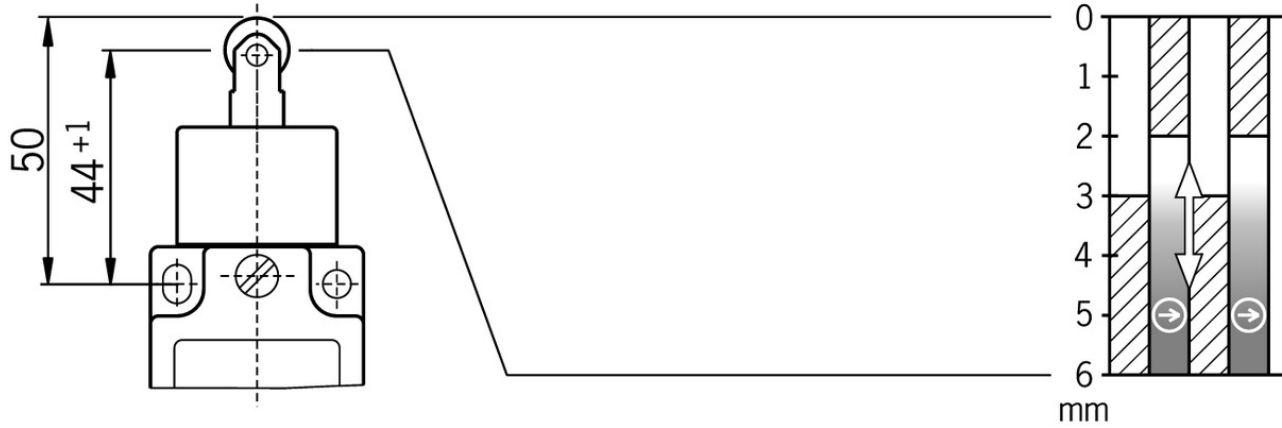

13-14
21-22
33-34
41-42



Legende

-  Contacts closed
-  Contacts open
-  Contacts positively driven





Instructions

- Betriebsanleitung Sicherheitsschalter NZ.R...EX

	Doc. no.	Version	Language	Download
Betriebsanleitung Sicherheitsschalter NZ.R...EX Operating Instructions Safety Switch NZ.R...EX	2094174	12-02/18	 	 0.8 MB

Catalogs







- ATEX - Sicherheitsschalter für explosionsgefährdete Bereiche ATEX - Safety switches for potentially explosive atmospheres ATEX - Interrupteurs de sécurité pour atmosphères explosibles ATEX - Interruptores de seguridad para uso en atmósferas potencialmente explosivas

	Doc. no.	Version	Language	Download
ATEX - Sicherheitsschalter für explosionsgefährdete Bereiche	136804	03-04/17		 1.5 MB
ATEX - Interrupteurs de sécurité pour atmosphères explosibles	136806	03-04/17		 1.5 MB

ATEX - Interruptores de seguridad para uso en atmósferas potencialmente explosivas	136807	03-04/17		 1.5 MB
ATEX - Safety switches for potentially explosive atmospheres	136805	03-04/17		 1.0 MB

Declaration of conformity

EU-Konformitätserklärung

	Doc. no.	Version	Language	Download
EU-Konformitätserklärung	2093482	13-06/16		 0.3 MB
Declaración UE de conformidad				
Déclaration UE de conformité				
Dichiarazione di conformità				
EU declaration of conformity				

CAD data

CAD data for this item on TraceParts