

ITEM 112673 C-M23F19-19XDIFPU05,0-M23M19-112673

Description	Technical data	Accessories	Downloads
-------------	----------------	-------------	-----------

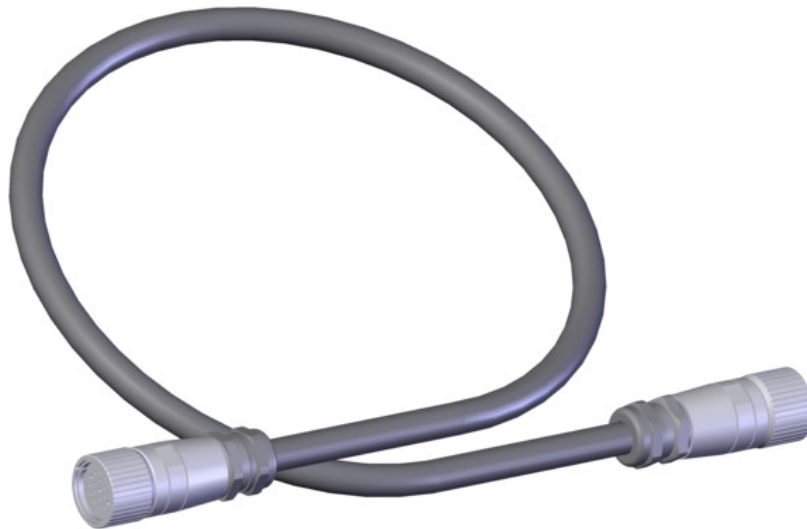

Features

- › M23 female plug, 18-pin + PE
- › M23 male plug, 18-pin + PE
- › Straight plug connector
- › PUR cable
- › Cable length 5 m
- › Cores numbered, black

Connector assignment

Plug connector (view of connection side)	Pin	Cross-section	Conductor coloring
	1	0.5 ²	VT
	2	0.5 ²	RD
	3	0.5 ²	GY
	4	0.5 ²	RDBU
	5	0.5 ²	GN
	6	1.0 ²	BU

Plug connector (view of connection side)	Pin	Cross-section	Conductor coloring
	7	0.5 ²	GYPK
	8	0.5 ²	GNWH
	9	0.5 ²	YEWH
	10	0.5 ²	GYWH
	11	0.5 ²	BK
	12	1.0 ²	GNYE
	13	0.5 ²	PK
	14	0.5 ²	BNGY
	15	0.5 ²	BNYE
	16	0.5 ²	BNGN
	17	0.5 ²	WH
	18	0.5 ²	YE
	19	1.0 ²	BN

Approvals



Mechanical values and environment

Sheath material	PUR
Conductor insulation material	PVC
Conductor material	EL-Cu flexible wire bare super fine strands
Fire behavior	Flame retardant according to VDE 0472 804
Drag chain suitability	Yes
Ambient temperature	Dynamic -20 ... +90 °C static -40 ... +90 °C
Number of conductors	19
Type of cable	straight
Cable length	5 m
Cable diameter	Approx. 11,6 mm
Conductor cross-section	16x 0.5 mm ² + 3x 1 mm ²
Conductor identification	Color code
Sheath color	Black
Bending radius	Dynamic 10x cable diameter
	Connection 1

Degree of protection	IP65 / IP67 [1]
Plug lock material	CuZn, nickel-plated
Designation of plug connector	RC [2]
Insertion cycles	50
Connection	Plug connector M23
Connection type	Socket
Cable outlet	straight
Number of pins	19 [3]
Plug lock	Screw connection
Plug housing material	CuZn, nickel-plated
	Connection 2
Degree of protection	IP65 / IP67 [4]
Plug lock material	CuZn, nickel-plated
Designation of plug connector	RC [5]
Insertion cycles	50
Connection	Plug connector M23
Connection type	Plug
Cable outlet	straight
Number of pins	19 [6]
Plug lock	Screw connection
Plug housing material	CuZn, nickel-plated

Electrical connection ratings

Rated voltage	150 V
Overtoltage category according to IEC EN 60664-1	II
Test voltage	1,5 kV
	Connection 1
Degree of contamination according to EN 60664-1	3
	Connection 2
Degree of contamination according to EN 60664-1	3

[1, 4] Locked

[2, 5] With screen bonding clamp

[3, 6] 16+3

Dimension drawing

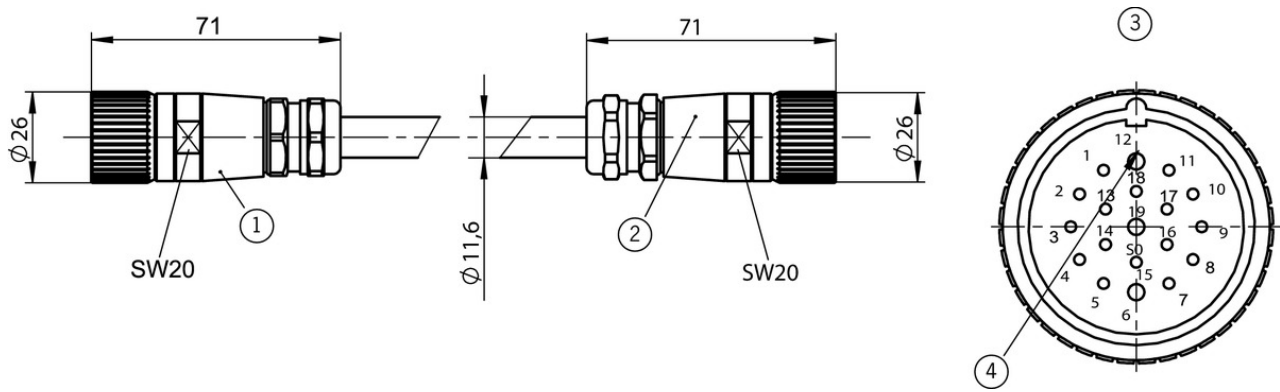

Legende

- 1 Female plug M23, 19-pin
- 2 Male plug M23, 19-pin
- 3 Terminal assignment as seen from the connection side
- 4 12 (PE with screen bonding clamp)