

ITEM 122704 C-RJ45-8X014PU20,0-MA-122704

Description	Technical data	Accessories	Downloads
-------------	----------------	-------------	-----------



Features

- › RJ45 plug connector
- › Straight plug connector
- › PUR cable
- › Cable length 20 m
- › With flying lead

Approvals



Mechanical values and environment

Plug housing material	TPU
Sheath material	PUR
Conductor material	PASW [1]
Halogen-free	Yes

Drag chain suitability	Yes
Silicone-free	Yes
Ambient temperature	
static	-20 ... +75 °C
Designation of plug connector	RJ45
Number of conductors	8 [2]
Cable length	20 m
Cable diameter	
Approx.	6,8 mm
Conductor cross-section	0.14 mm ²
Conductor identification	Color code
Sheath color	Black
Bending radius	
static	10 x cable diameter
	Connection 1
Interlocking	Snap-on
Degree of protection	IP20
Plug lock material	CuZn, nickel-plated
Insertion cycles	750
Connection	RJ45
Connection type	Plug
Cable outlet	straight
Number of pins	8
Plug housing material	PC
	Connection 2
Conductor end	Sheath stripped
Connection	Flying lead

Electrical connection ratings

Operating voltage AC	300 V AC
Nominal current	
At 40°C	1 A
Operating voltage DC	450 V DC
Rated voltage	
AC	30 V
DC	42 V
Overvoltage category according to IEC EN 60664-1	-
Rated surge voltage according to IEC 60664-1	1000 V
Degree of contamination according to EN 60664-1	3
Cable shielding	Yes
Contact resistance	20 mΩ

[1] 7 x Ø 0,16 mm (26 AWG)

[2] 4 pair

Dimension drawing

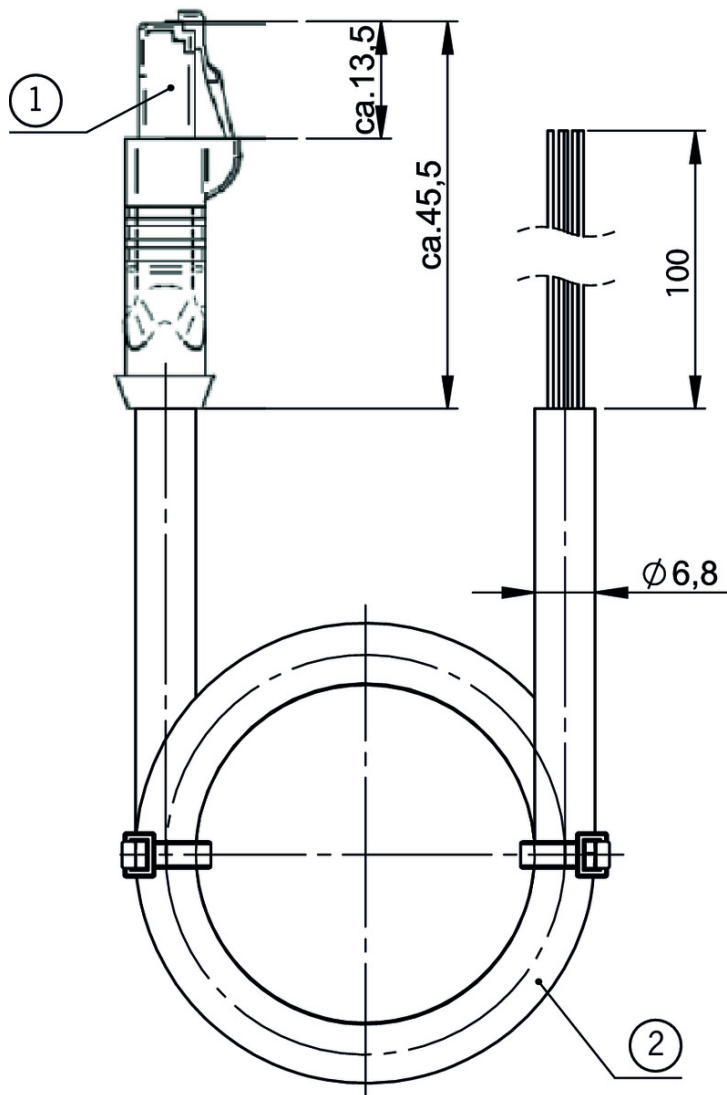

Legende

1 Male plug / 8-pin

2 PUR cable S/FTP - 8x 0.14 mm²

Terminal assignment

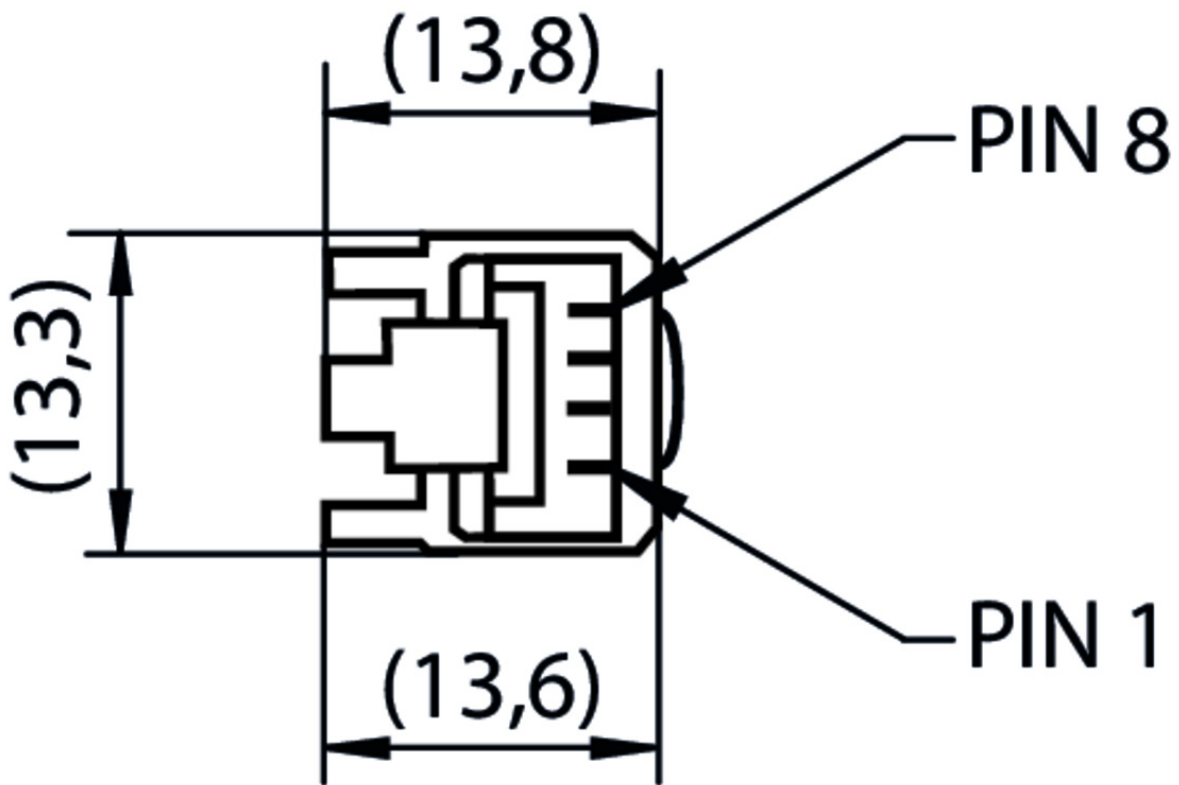

Legende

Screen foil over each pair

Pair 1 Pin 5 (WH) + Pin 4 (BU)

Pair 2 Pin 1 (WH) + Pin 2 (OG)

Pair 3 Pin 3 (WH) + Pin 6 (GN)

Pair 4 Pin 7 (WH) + Pin 8 (BN)