

ITEM 155865 AE-SET-LCHN-A1-155865

Description	Technical data	Accessories	Downloads
-------------	----------------	-------------	-----------

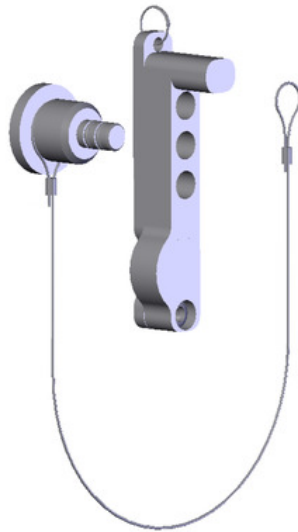

Features

- › Prevents unintentional closing of the door
- › Can be secured with padlocks

The lockout bar can be used to prevent maintenance personnel from being unintentionally locked in the danger area, for example. The lockout bar is fitted to the CET actuator (CET-A-BWK-50X-096327) with the safety guard open and can be secured with max. 3 padlocks.

Components included in the set



156429 AE-L-CET-156429
✓ Features



156338 Y-CHN-A1-156338
✓ Features

Dimension drawing

Halterung für CET Sperreinsatz /
Holder for CET lockout device

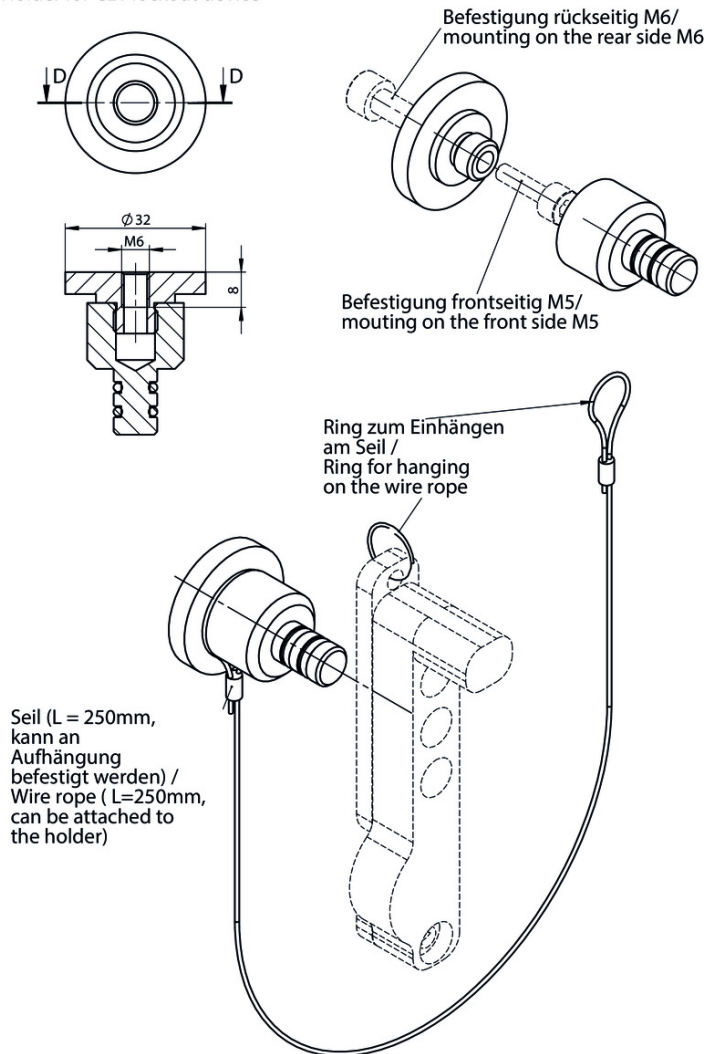

Function expansion

✓ Lockout mechanism for CET actuator



156429 AE-L-CET-156429

✓ Features

- › Prevents unintentional closing of the door
- › Can be secured with padlocks

✓ Holder for lockout mechanism CET actuator









156338 Y-CHN-A1-156338

✓ Features

- › Holder (incl. wire rope) for lockout bar CET

Catalogs

- ▼ Transpondercodierte Sicherheitsschalter - Verriegelungseinrichtungen und Zuhaltungen
Transponder-coded safety switches - Interlocking devices and guard locking devices
Interruptores de seguridad con codificación por transponder - Dispositivos de enclavamiento y bloqueos
Interrupteurs de sécurité à codage par transpondeur - Dispositifs de verrouillage et interverrouillages

	Doc. no.	Version	Language	Download
Transpondercodierte Sicherheitsschalter - Verriegelungseinrichtungen und Zuhaltungen	127594	02-01/18		 5.2 MB
Interrupteurs de sécurité à codage par transpondeur - Dispositifs de verrouillage et interverrouillages	137558	02-01/18		 5.2 MB
Interruptores de seguridad con codificación por transponder - Dispositivos de enclavamiento y bloqueos	137560	02-01/18		 5.2 MB
Transponder-coded safety switches - Interlocking devices and guard locking devices	127595	02-01/18		 5.1 MB

- ▼ Transpondercodierte Sicherheitssysteme mit externer Auswertung
Transponder-coded safety systems with external evaluation
Sistemas de seguridad con codificación por transponder y evaluación externa
Systèmes de sécurité à codage par transpondeur avec analyse externe

	Doc. no.	Version	Language	Download
Transpondercodierte Sicherheitssysteme mit externer Auswertung	127596	02-01/18		 3.1 MB
Systèmes de sécurité à codage par transpondeur avec analyse externe	137968	02-01/18		 3.0 MB
Sistemas de seguridad con codificación por transponder y evaluación externa	139969	02-01/18		 3.0 MB
Transponder-coded safety systems with external evaluation	127597	02-01/18		 3.0 MB