

ITEM 156935 CES-A-BDA-18-156935

| Description | Technical data | Accessories | Downloads |
|-------------|----------------|-------------|-----------|
|-------------|----------------|-------------|-----------|

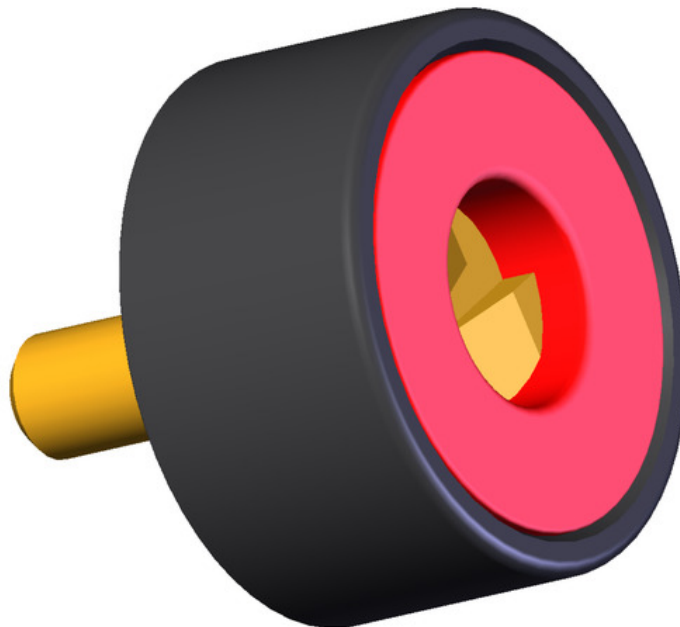

Features

- › For safety switches CES-C01 and read heads CES-A-LNA
- › Round design \varnothing 18 mm
- › For use in applications in very confined spaces
- › Mounting on metal is permissible
- › Flush mounting is permissible only in plastic

Attention: The operating distance decreases in case of flush installation in metal.

Approvals



Mechanical values and environment

| | | |
|----------|-------------|----------|
| Material | Active face | PEEK 450 |
|----------|-------------|----------|

| | | |
|-----------------------|------------------------|--------------------------------|
| Housing material | Sleeve | PBT-GF30 |
| Weight | Net | 0,003 kg |
| Ambient temperature | | -25 ... 70 °C |
| Degree of protection | according to IEC 60529 | IP 65 / IP 67 |
| Installation position | | Active face opposite read head |
| Tightening torque | Fixing screws | min.2 Nm |

Electrical connection ratings

| | |
|--------------|-------------------------|
| Power supply | Inductive via read head |
|--------------|-------------------------|

Operating distance

| | |
|--|-----------------------|
| Distance s, actuator | |
| Minimum distance for side approach direction | min.8 mm |
| Switching hysteresis | |
| With center offset m=0 | 1 ... 3 mm [1] |
| Switch-on distance | |
| With center offset m=0 | 19 mm [2] |
| Assured switch-off distance S_{ar} | |
| With center offset m=0 | max.45 mm [3] |
| Assured operating distance S_{a0} | |
| With center offset m=0 | min.10 mm [4] |

[1, 2, 3, 4] These values apply to surface installation of the actuator.

Dimension drawing

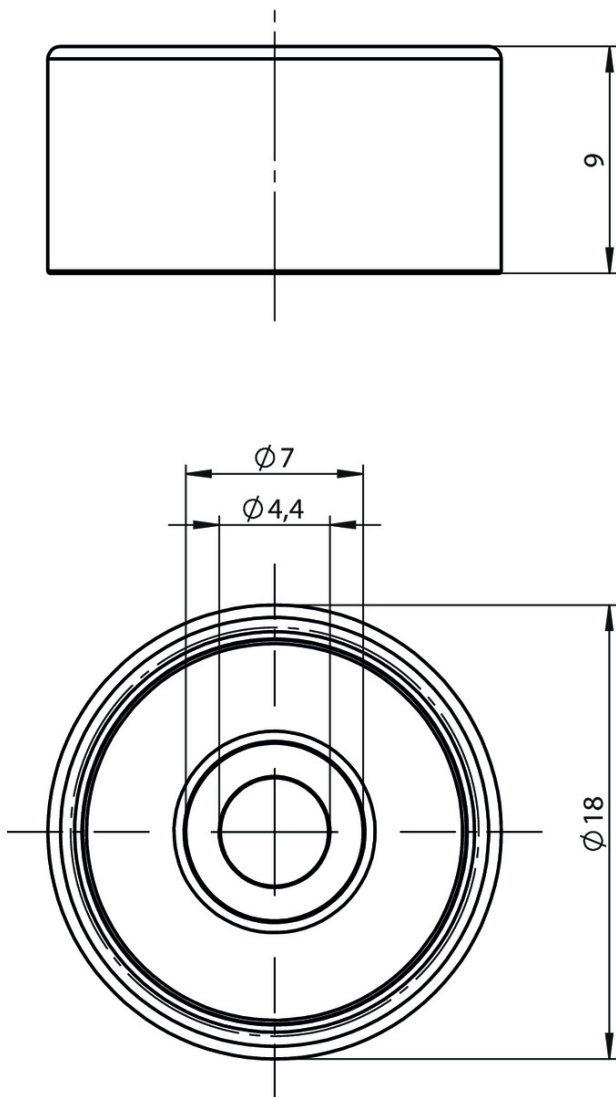

Mounting accessories

- ✓ Safety screws M4 x 14





071863 M4X14-CES/V20

- ✓ Features

- › Safety screws M4 x 14
- › Packaging unit 20 pieces

Catalogs

- ✓ Transpondercodierte Sicherheitsschalter - Verriegelungseinrichtungen und Zuhaltungen
Transponder-coded safety switches - Interlocking devices and guard locking devices
Interruptores de seguridad con codificación por transponder - Dispositivos de enclavamiento y bloqueos
Interrupteurs de sécurité à codage par transpondeur - Dispositifs de verrouillage et interverrouillages

| | Doc. no. | Version | Language | Download |
|---|-----------------|----------------|---|--|
| Transpondercodierte Sicherheitsschalter - Verriegelungseinrichtungen und Zuhaltungen | 127594 | 02-01/18 |  |  5.2 MB |
| Interrupteurs de sécurité à codage par transpondeur - Dispositifs de verrouillage et interverrouillages | 137558 | 02-01/18 |  |  5.2 MB |
| Interruptores de seguridad con codificación por transponder - Dispositivos de enclavamiento y bloqueos | 137560 | 02-01/18 |  |  5.2 MB |
| Transponder-coded safety switches - Interlocking devices and guard locking devices | 127595 | 02-01/18 |  |  5.1 MB |