

ITEM 113767 CET4-AR-CRA-CH-50X-SG-C2333-113767

Description	Technical data	Accessories	Downloads
-------------	----------------	-------------	-----------



Features

- › Safety switch with guard locking and integrated evaluation electronics
- › Locking force up to 6500 N
- › Up to 20 switches in series
- › Short circuit monitoring
- › 2 safety outputs (semiconductor outputs)
- › Up to category 4/PL e according to EN ISO 13849-1
- › With 2 plug connectors M12
- › Multicode
- › Door monitoring output
- › Indication of the door position by LED
- › Lockout bar
- › Approach direction A (default setting on delivery)

Approach direction

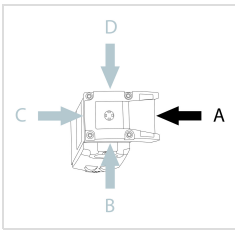

► Figure

Horizontal

Can be adjusted in 90° steps

Lockout mechanism

The lockout mechanism can be used to prevent maintenance personnel from being unintentionally locked in the danger zone, for example.

Important: The lockout mechanism is not a safety function.

This device with lockout mechanism possesses no mechanical release.

Safety switch

The device may be operated only in conjunction with the actuator CET-A-....

Important: The actuator must be ordered separately.

Multicode evaluation unit

Every suitable actuator is detected by the switch.

Solenoid operating voltage

► DC 24 V +10% -15%

Guard locking type

CET4 Open-circuit current principle guard locking by solenoid force.

Activation of the guard locking by applying voltage to the guard locking solenoid. The door position is also monitored. The door monitoring output OUT D is set to HIGH as soon as the actuator is above the extended plunger (state: door closed, guard locking not active). The output OUT D remains set also with guard locking active.

LED function display

LED State Status LED

LED DIA Diagnostic LED

LED 1 rd freely configurable

LED 2 gn illuminates when door is closed

Additional connections

OUT Monitoring output (semiconductor)

OUT D Door monitoring output

RST Reset input

Category according to EN ISO 13849-1

Due to two redundantly designed semiconductor outputs (safety outputs) with internal monitoring suitable for:

› Category 4/PL e according to EN ISO 13849-1

Important: To achieve the stated category in accordance with EN ISO 13849-1, both safety outputs (OA and OB) must be evaluated.

The category is dependent on the installation position of the safety switch:

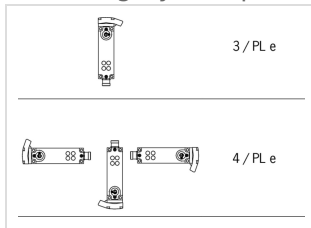

› Figure

Kommentar_NT!

Approvals



Mechanical values and environment

Housing material		
	Slide	Stainless steel
	Safety switch housing	Die-cast aluminum
Weight		
	Net	1 kg
Ambient temperature		
	At $U_B = 24V DC$	-20 ... 55 °C
Degree of protection		IP67 [1]
Resilience to vibration		In acc. with EN IEC 60947-5-2
Mechanical life		1×10^6
Installation position		Any [2]
Degree of freedom		
	Z	± 4 mm
	Y	± 5 mm
	X	± 5 mm
Ready delay		10 s
Switching frequency		max.0,5 Hz
Connection		2 plug connectors M12, 5 and 8-pin
Approach speed		20 m/min
Guard locking principle		Open-circuit current principle
Locking force F_{max}		6500 N
Locking force F_{Zh}		5000 N [3]

Electrical connection ratings

Operating voltage DC		
	U_B	24 V DC -15% ... 15% Reverse polarity protected, regulated, residual ripple < 5%, PELV
	LED	24 V DC -15% ... 10%
Current consumption		
	I_B	80 mA
	I_{CM}	480 mA
Utilization category according to EN 60947-5-2		
	DC-13	24V 200mA [4]
Solenoid operating voltage DC		
	U_{CM}	24 V DC -15% ... +10% Reverse polarity protected, regulated, residual ripple < 5%, PELV
Fusing		
	External (operating voltage U_B)	0,25 ... 2 A
	External (solenoid operating voltage U_{CM})	0,5 ... 8 A
Power consumption		
	Solenoid	max.14 W
EMC protection requirements		In acc. with EN IEC 60947-5-3
Solenoid duty cycle		100 %
Degree of contamination (external, according to EN 60947-1)		3
Connecting cable		30V DC, 2A [5]
Safety class		
	EN IEC 61140	III
Switching load		
	According to UL	24V DC, class 2 [6]
Safety outputs OA/OB		
Type of output		2 semiconductor outputs, p-switching, short circuit-proof
Switching current		
	Per safety output OA / OB	1 ... 200 mA
Output voltage		
	High $U(OA) / U(OB)$	$U_B - 1,5V \dots U_B$ V DC
	Low $U(OA) / U(OB)$	0 ... 1 V DC
Off-state current I_r		max.0,25 mA
Risk time according to EN 60947-5-3		
	Single device	max.400 ms
	Delay per device	5 ms
Switch-on time		400 ms
Discrepancy time		
	Both safety outputs	max.10 ms
Monitoring output OUT		
Type of output		p-switching, short circuit-proof
Switching current		
	OUT	1 ... 50 mA

Output voltage	OUT	0,8xUB ... UB V DC
Switching delay from state change		max.400 ms
Monitoring output OUT D		
Type of output		p-switching, short circuit-proof
Switching current	OUT D	1 ... 50 mA
Output voltage	OUT D	0,8xUB ... UB V DC
Switching delay from state change		max.700 ms

Operating distance

Repeat accuracy R		
According to EN 60947-5-2		10 %

Miscellaneous

C number	C2333	With lockout mechanism mounted
For the approval according to UL the following applies		Operation only with UL class 2 power supply, or equivalent measures see operating instructions

Reliability values acc. to EN ISO 13849-1

		Monitoring of guard locking and the safety guard position
Category	Head upward	3
	Head downward or horizontal	4
Performance Level		PL e
PFH _D	Head upward	4.29 x 10 ⁻⁸
	Head downward or horizontal	3.1 x 10 ⁻⁹

Mission time		20 y
--------------	--	------

- [1] Screwed tight plug connector/mating component
- [2] Preferably head downward
- [3] $FZH = FMAX/1.3$
- [4] Caution: outputs must be protected with a free-wheeling diode in case of inductive loads
- [5] For UL requirement UL category code (CYJV/CYJV7)
- [6] For alternatives see operating instructions

Dimension drawing

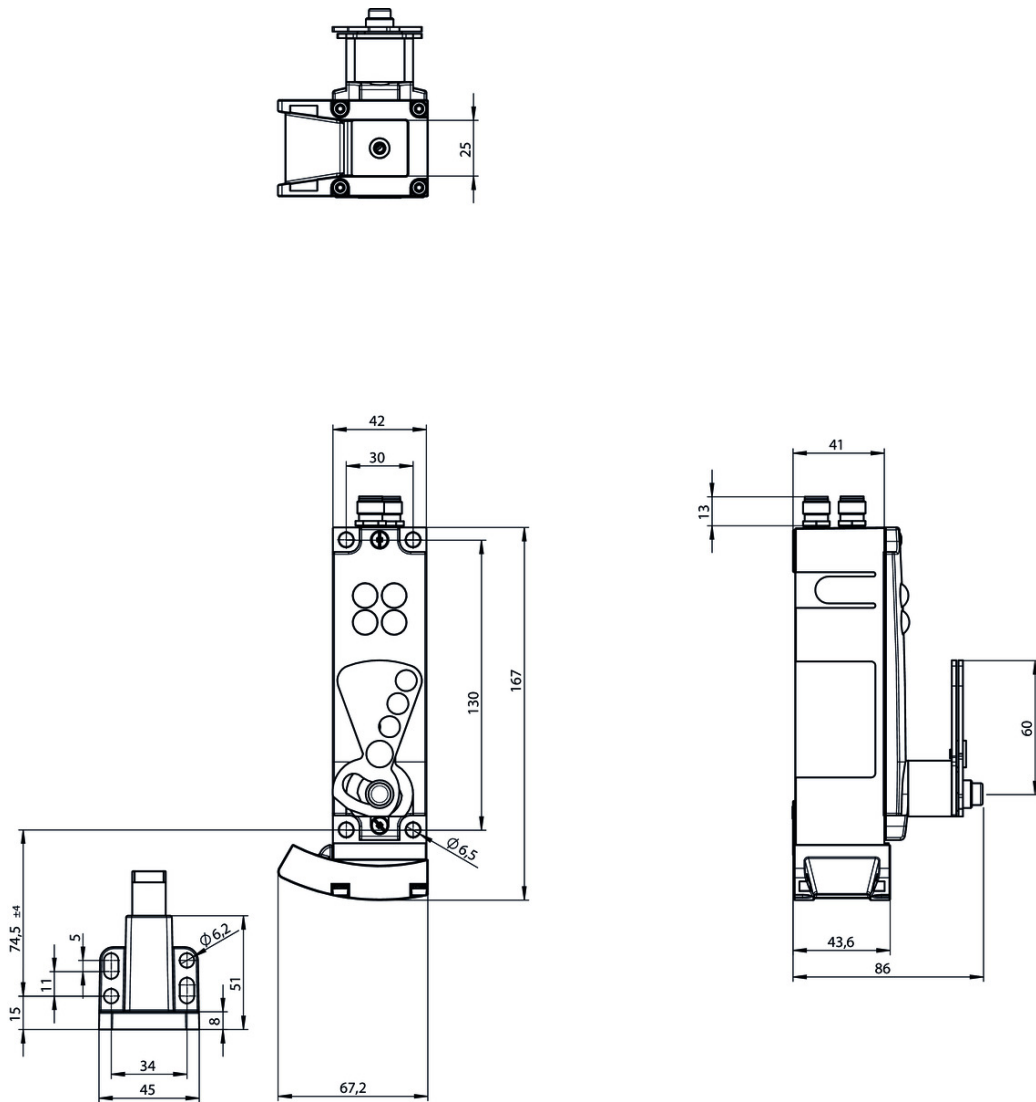

Block diagram

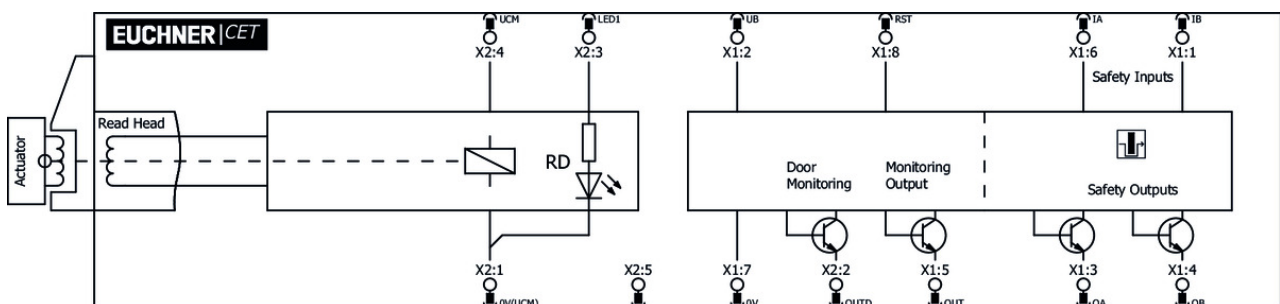

Connection material

- ▼ Connection cable with plug connector M12, 5-pin, 10m



100184 C-M12F05-05X034PV10,0-MA-100184

- ▼ Features

- › M12 female plug, 5-pin
 - › Straight plug connector
 - › PVC cable
 - › Cable length 10 m
 - › With flying lead
-

- ▼ Connection cable with straight plug connector M12, 5-pin, 5m



100183 C-M12F05-05X034PV05,0-MA-100183

- ▼ Features

- › M12 female plug, 5-pin
 - › Straight plug connector
 - › PVC cable
 - › Cable length 5 m
 - › With flying lead
-



113620 C-M12F05-05X034PU05,0-MA-113620

- ▼ Features

- › M12 female plug, 5-pin
 - › Straight plug connector
 - › PUR cable
 - › Cable length 5 m
 - › With flying lead
-

- ▼ Connection cable with angled plug connector M12, 5-pin, 10m



113187 C-M12F05-05X025PU10,0-MA-113187

- ▼ Features

- › M12 female plug, 5-pin
 - › Angled plug connector
 - › PUR cable
 - › Cable length 10 m
 - › Cable exit A (right)
 - › With flying lead
-



113190 C-M12F05-05X025PU10,0-MA-113190

- ▼ Features

- › M12 female plug, 5-pin
 - › Angled plug connector
 - › PUR cable
 - › Cable length 10 m
 - › Cable exit C (left)
 - › With flying lead
-

- ▼ M12 extension PUR 5-pin, plug connectors at both ends, 10m

115566 C-M12F05-05X025PU10,0-M12M05-115566



▼ Features

- › M12 female plug, 5-pin (angled) to M12 plug connector (straight)
 - › Connectors at both ends
 - › PUR cable
 - › Cable length 10 m
 - › With cable exit C (left)
-



115565 C-M12F05-05X025PU10,0-M12M05-115565

▼ Features

- › M12 female plug, 5-pin (angled) to M12 plug connector (straight)
 - › Connectors at both ends
 - › PUR cable
 - › Cable length 10 m
 - › With cable exit A (right)
-

▼ Y-distributor M12



097627 Y-VERTEILER M12

▼ Features

- › Y-distributor M12, 2 x 5-pin, 1 x 8-pin
 - › Straight plug connector
-

▼ Connection cable with plug connector M12, 8-pin, 5m



100177 C-M12F08-08X025PV05,0-MA-100177

▼ Features

- › M12 female plug, 8-pin
 - › Straight plug connector
 - › PVC cable
 - › Cable length 5 m
 - › With flying lead
-



115112 C-M12F08-08X025PU05,0-MA-115112

▼ Features

- › M12 female plug, 8-pin
 - › Straight plug connector
 - › PUR cable
 - › Cable length 5 m
 - › With flying lead
-

▼ Connection cable with angled plug connector M12, 8-pin, 10m



113188 C-M12F08-08X025PU10,0-MA-113188

▼ Features

- › M12 female plug, 8-pin
 - › Angled plug connector
 - › Cable outlet A (right)
 - › PUR cable
 - › Cable length 10 m
 - › With flying lead
-

113189 C-M12F08-08X025PU10,0-MA-113189



- ▼ Features
 - › M12 female plug, 8-pin
 - › Angled plug connector
 - › Cable outlet C (left)
 - › PUR cable
 - › Cable length 10 m
 - › With flying lead
-

▼ Connection cable with plug connector M12, 8-pin, 10m



100178 C-M12F08-08X025PV10,0-MA-100178

- ▼ Features
 - › M12 female plug, 8-pin
 - › Straight plug connector
 - › PVC cable
 - › Cable length 10 m
 - › With flying lead
-



115113 C-M12F08-08X025PU10,0-MA-115113

- ▼ Features
 - › M12 female plug, 8-pin
 - › Straight plug connector
 - › PUR cable
 - › Cable length 10 m
 - › With flying lead
-

▼ Connection cable with plug connector M12, 8-pin, 20m



100179 C-M12F08-08X025PV20,0-MA-100179

- ▼ Features
 - › M12 female plug, 8-pin
 - › Straight plug connector
 - › PVC cable
 - › Cable length 20 m
 - › With flying lead
-



115114 C-M12F08-08X025PU20,0-MA-115114

- ▼ Features
 - › M12 female plug, 8-pin
 - › Straight plug connector
 - › PUR cable
 - › Cable length 20 m
 - › With flying lead
-

▼ Connection cable with plug connector M12, 5-pin, 20m



100185 C-M12F05-05X034PV20,0-MA-100185

- ▼ Features
 - › M12 female plug, 5-pin
 - › Straight plug connector
 - › PVC cable
 - › Cable length 20 m

- › With flying lead
-

▼ Bridging plug M12



097645 BRUECKEN-STECKER

▼ Features

- › Bridging plug
 - › M12 male plug, 4-pin
-

▼ Y-distributor M12 with connection cable



111696 Y-VERTEILER M12 MIT ANSCHLUSSKABEL

▼ Features

- › Y-distributor M12 with connection cable, 2 x 5-pin, 1 x 8-pin
 - › Straight plug connector
 - › PVC cable
 - › Cable length 0.2 m
-



112395 Y-VERTEILER M12 MIT 1M KABEL

▼ Features

- › Y-distributor M12 with connection cable, 2 x 5-pin, 1 x 8-pin
 - › Straight plug connector
 - › PVC cable
 - › Cable length 1 m
-

▼ Connection cable with 2 plug connectors M12, 5-pin, 5m



100180 C-M12F05-05X034PV05,0-M12M05-100180

▼ Features

- › M12 female plug to M12 plug connector, 5-pin
 - › Straight female plug and plug connector
 - › PVC cable
 - › Cable length 5 m
-



119932 C-M12F05-05X034PU05,0-M12M05-119932

▼ Features

- › M12 female plug to M12 plug connector, 5-pin
 - › Straight female plug and plug connector
 - › PUR cable
 - › Cable length 5 m
-

▼ Connection cable with 2 plug connectors M12, 5-pin, 10m



100181 C-M12F05-05X034PV10,0-M12M05-100181

▼ Features

- › M12 female plug to M12 plug connector, 5-pin
 - › Straight female plug and plug connector
 - › PVC cable
 - › Cable length 10 m
-



119947 C-M12F05-05X034PU10,0-M12M05-119947

▼ Features

- › M12 female plug to M12 plug connector, 5-pin
 - › Straight female plug and plug connector
 - › PUR cable
 - › Cable length 10 m
-

▼ Connection cable with 2 plug connectors M12, 5-pin, 20m



100182 C-M12F05-05X034PV20,0-M12M05-100182

▼ Features

- › M12 female plug to M12 plug connector, 5-pin
 - › Straight female plug and plug connector
 - › PVC cable
 - › Cable length 20 m
-



119971 C-M12F05-05X034PU20,0-M12M05-119971

▼ Features

- › M12 female plug to M12 plug connector, 5-pin
 - › Straight female plug and plug connector
 - › PUR cable
 - › Cable length 20 m
-

▼ Connection cable with plug connector M12, 8-pin, 30m



115257 C-M12F08-08X025PU30,0-MA-115257

▼ Features

- › M12 female plug, 8-pin
 - › Straight plug connector
 - › PUR cable
 - › Cable length 30 m
 - › With flying lead
-



115116 C-M12F08-08X025PV30,0-MA-115116

▼ Features

- › M12 female plug, 8-pin
 - › Straight plug connector
 - › PVC cable
 - › Cable length 30 m
 - › With flying lead
-

▼ Passive distribution module



120861 AC-DP-04-SA-120861

▼ Features

- › Connection of up to 4 CES-AR, CET-AR, CTP-AR and ESL-AR
 - › LEDs for the indication of the door position on each port
 - › Can be connected in series
-

▼ Connection cable with straight plug connector M12, 5-pin, 30 m



122784 C-M12F05-05X034PU30,0-MA-122784

▼ Features

- › M12 female plug, 5-pin
 - › Straight plug connector
 - › PUR cable
 - › Cable length 30 m
 - › With flying lead
-

▼ Connection cable with straight plug connector M12, 5-pin, 20 m



113682 C-M12F05-05X034PU20,0-MA-113682

▼ Features

- › M12 female plug, 5-pin
 - › Straight plug connector
 - › PUR cable
 - › Cable length 20 m
 - › With flying lead
-

▼ Connection cable with straight plug connector M12, 5-pin, 10m



113640 C-M12F05-05X034PU10,0-MA-113640

▼ Features

- › M12 female plug, 5-pin
 - › Straight plug connector
 - › PUR cable
 - › Cable length 10 m
 - › With flying lead
-

▼ Connection cable with angled plug connector M12, 8-pin, 20m



120998 C-M12F08-08X025PU20,0-MA-120998

▼ Features

- › M12 female plug, 8-pin
 - › Angled plug connector
 - › Cable outlet A (right)
 - › PUR cable
 - › Cable length 20 m
 - › With flying lead
-



120999 C-M12F08-08X025PU20,0-MA-120999

▼ Features

- › M12 female plug, 8-pin
 - › Angled plug connector
 - › Cable outlet C (left)
 - › PUR cable
 - › Cable length 20 m
 - › With flying lead
-

▼ Connection cable with 2 plug connectors M12, 1m



123430 C-M12M08-08X025PV01,0-M12F08-123430

▼ Features

- › 8-pin M12 male plug, straight
 - › 8-pin M12 female connector, straight
 - › PVC cable
 - › Cable length 1m
-

▼ Connection cable with 2 plug connectors M12, 2m



123431 C-M12M08-08X025PV02,0-M12F08-123431

▼ Features

- › 8-pin M12 male plug, straight
 - › 8-pin M12 female connector, straight
 - › PVC cable
 - › Cable length 2m
-

▼ Connection cable with 2 plug connectors M12, 5m



123432 C-M12M08-08X025PV05,0-M12F08-123432

▼ Features

- › 8-pin M12 male plug, straight
 - › 8-pin M12 female connector, straight
 - › PVC cable
 - › Cable length 5m
-

▼ Connection cable with 2 plug connectors M12, 10m



123433 C-M12M08-08X025PV10,0-M12F08-123433

▼ Features

- › 8-pin M12 male plug, straight
 - › 8-pin M12 female connector, straight
 - › PVC cable
 - › Cable length 10m
-

Bolt

▼ Bolt CET-A-C



104309 RIEGEL CET-A-C

▼ Features

- › Steel bolt
 - › In combination with CET
 - › For left or right hinged doors
 - › Can be locked in open position with padlocks
-



109672 RIEGEL CET-A-C-C2308

▼ Features

- › Steel bolt
 - › In combination with CET
 - › For left or right hinged doors
 - › Can be locked in open position with padlocks
 - › Bolt without door stop, suitable for swing doors
-

Function expansion

✓ Cover for read head and actuator CET



098807 CET ABDECKUNG LINKS

✓ Features

- › Cover for read heads / safety switches CET and actuators CET
- › For approach direction C



098808 CET ABDECKUNG RECHTS

✓ Features

- › Cover for read heads / safety switches CET and actuators CET
- › For approach direction A

✓ Double ramp for safety switch/read head CET



114091 CET-DR

✓ Cover for actuator CET



124979 AM-C-124979

✓ Features

- › Cover for actuator CET
- › Horizontal and vertical fastening option on the actuator
- › Mounting using 4 screws M5x16 (included with the actuator)
- › Not suitable in combination with lockout bar for actuator CET

✓ Lockout mechanism for CET actuator



122609 AE-L-CET-122609

✓ Features

- › Prevents unintentional closing of the door
- › Can be secured with padlocks
- › Not suitable in combination with cover AM-C for actuator CET

Mounting accessories

✓ Mounting plate EMP-L... for CET read head/switches



106695 EMP-L-CET

✓ Features

- › Mounting plate for CET read heads/switches
- › For hinged or sliding doors
- › Suitable for aluminum profiles 40 ... 45 mm
- › Horizontal and vertical mounting
- › Suitable for CET with escape release

▼ Mounting plate EM-P switch for safety switch CET



126399 AM-P-126399

▼ Features

- › Mounting plate for CET read heads/switches
 - › Direct mounting on aluminum profiles of width 30/40/50 mm
 - › Suitable for the mounting plates AM-P-126400 and AM-P-126398
-

▼ Mounting plate EM-P actuator for safety switch CET



126400 AM-P-126400

▼ Features

- › Mounting plate for CET actuator
 - › Suitable for mounting on aluminum profiles of width 30/40/50 mm
 - › Suitable for the mounting plates AM-P-126399 and AM-P-126398
-

▼ Mounting plate EM-P handle for safety switch CET



126398 AM-P-126398

▼ Features

- › Mounting plate with handle (handle included)
 - › For hinged or sliding doors
 - › Horizontal and vertical assembly circuits possible
 - › Suitable for aluminum profiles of width 30/40/50 mm
 - › Suitable for the CET mounting plates AM-P-126399 and AM-P-126400
-

▼ Mounting plate EMP-B-... for actuator CET



106694 EMP-B-CET

▼ Features

- › Mounting plate for actuator CET for hinged or sliding doors
 - › Suitable for aluminum profiles 40 ... 45 mm
 - › Horizontal and vertical mounting
 - › Made of aluminum
-

Actuator

▼ Actuator CET-A-BWK-50X



096327 CET-A-BWK-50X

▼ Features

- › Actuator for read head/safety switch CET
 - › Four safety screws M5x16 included
-

Instructions

▼ Bezpečnostní informace CET (-AR/-AP)





	Doc. no.	Version	Language	Download
Sicherheitsinformation CET (-AR/-AP)	105517	14-01/17		0.7 MB
Información de seguridad CET (-AR/-AP)				
Information de sécurité CET (-AR/-AP)				
Informazioni sulla sicurezza CET (-AR/-AP)				
Safety Information CET (-AR/-AP)				
Bezpečnostní informace CET (-AR/-AP)	105517	14-01/17		0.2 MB
Informação de segurança CET (-AR/-AP)	105517	14-01/17		0.2 MB
Güvenlik bilgisi CET (-AR/-AP)	105517	14-01/17		0.3 MB
安全情報 CET (-AR/-AP)	105517	14-01/17		0.6 MB
Информация о безопасности CET (-AR/-AP)	105517	14-01/17		0.3 MB
安全信息 CET (-AR/-AP)	105517	14-01/17		0.3 MB

Návod k použití Bezpečnostní spínač s kódovaným transpondérem a jištěním ochranného krytu CET.-AR-... (Unicode/Multicode)

	Doc. no.	Version	Language	Download
Betriebsanleitung Transpondercodierter Sicherheitsschalter mit Zuhaltung CET.-AR-... (Uni-/Multicode)	2110788	12-07/18		3.3 MB
Mode d'emploi Interrupteur de sécurité à codage par transpondeur avec interverrouillage CET.-AR-... (uni-/multicode)	2110788	12-07/18		3.3 MB
Manual de instrucciones Interruptor de seguridad con codificación por transponder con bloqueo CET.-AR-... (Unicode/Multicode)	2110788	12-07/18		3.3 MB
Návod k použití Bezpečnostní spínač s kódovaným transpondérem a jištěním ochranného krytu CET.-AR-... (Unicode/Multicode)	2110788	12-07/18		3.6 MB
Operating Instructions Transponder-Coded Safety Switch With Guard Locking CET.-AR-... (Unicode/Multicode)	2110788	12-07/18		3.3 MB
Istruzioni di impiego Finecorsa di sicurezza con codifica a transponder con meccanismo di ritenuta CET.-AR-... (Unicode/Multicode)	2110788	12-07/18		3.3 MB
操作指示書トランスポンダー型コード化安全スイッチ CET.-AR-... (ユニコード/マルチコード)	2110788	12-07/18		3.7 MB
Návod na prevádzku Bezpečnostný spínač kódovaný transpondérom s istením CET.-AR-... (Uni-/Multicode)	2110788	12-07/18		3.5 MB
İşletim kılavuzu Kapalı tutmalı CET.-AR-... (Uni-/Multicode)	2110788	12-07/18		3.7 MB
使用说明书应答机编码安全开关 CET.-AR-... (特殊/通用编码)	2110788	12-07/18		3.7 MB
Инструкция по эксплуатации Транспондерный предохранительный выключатель с защитной блокировкой CET.-AR-... (Uni-/Multicode)	2110788	12-07/18		3.8 MB







Application example

▼ Anschluss CET4-AR an Siemens ET 200S

	Doc. no.	Version	Language	Download
Anschluss CET4-AR an Siemens ET 200S	AP000103	07-03/16		 0.3 MB
Connection of CET4-AR to Siemens ET 200S	AP000103	07-03/16		 0.3 MB

Declaration of conformity

▼ EU-Konformitätserklärung

	Doc. no.	Version	Language	Download
EU-Konformitätserklärung	2110802	10-01/17		 0.3 MB
Declaración UE de conformidad				
Déclaration UE de conformité				
Dichiarazione di conformità				
EU declaration of conformity				

CAD data

CAD data for this item on TraceParts