

ITEM 156516 LCA-4TR-30-760-AP-156516

Description	Technical data	Accessories	Downloads
-------------	----------------	-------------	-----------



**Features**

- › Resolution 30 mm
- › Protective field height 760 mm
- › Range 12 m
- › With plug connector M12
- › Two safety outputs (OSSD)
- › Installation material is included with the product

**Protective function**



- › Figure  
hand protection

**LED function display**



► Figure  
Transmitter



► Figure  
Receiver

- LED OK** Normal operation
- LED ERROR** Fault state
- LED STOP** Stop state
- LED TEST** Test function
- LED START** Start/ restart

### Pin assignment transmitter

Plug connector (view of connection side)	Pin	Designation	Function	Conductor coloring of connection cable
	1	24 V DC	Operating voltage, 24 V DC	BN
	2	RANGE 0	Device configuration, corresponds to the standard EN 61131-2	WH
	3	0 V DC	Operating voltage, 0 V DC	BU
	4	RANGE 1	Device configuration, corresponds to the standard EN 61131-2	BK
	5	FE	Function earth (must be connected to meet the EMC requirements)	GY

### Connector assignment receiver

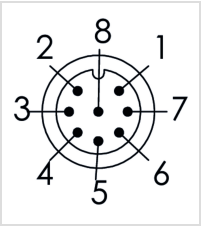
Plug connector (view of connection side)	Pin	Designation	Function	Conductor coloring of connection cable
	1	FO1A	Safety output, channel 1	WH
	2	24 V DC	Operating voltage, 24 V DC	BN
	3	FO1B	Safety output, channel 2	GN
	4	K1_K2/RESTART	Feedback external contactors	YE
	5	SEL_A	Device configuration	GY
	6	SEL_B	Device configuration	PK
	7	0 V DC	Operating voltage, 0 V DC	BU
	8	FE	Function earth (must be connected to meet the EMC requirements)	RD

## Approvals



## Mechanical values and environment

Number of safety outputs	2 Static, self-monitoring PNP safety outputs [1]
Resolution	30 mm
Height of the protective field	760 mm
Height of the sensor	813 mm
Maximum length of connection cables	100 m
Range of the protective field	12000 mm
Dimensions	28x30 mm [2]
Ambient temperature	-30 ... 55 °C
Degree of protection	IP 65 / IP 67
Installation position	Any [3]
Reaction time	10,5 ms
Connection	Plug connector M12 (5-pin transmitter / 8-pin receiver)

## Electrical connection ratings

Cascadable	No
------------	----

Muting possible	In combination with external sensors and an evaluation unit
Operating voltage DC	24 V DC -20% ... +20%
Current consumption	400 mA
Power consumption	
	Transmitter 1 W
	Receiver 2 W
LED indicator	Yes <b>[4]</b>

### Reliability values acc. to EN ISO 13849-1

ESPE type	4 <b>[5]</b>
Performance Level	PL e <b>[6]</b>
PFH <sub>D</sub>	1,32x10 <sup>-8</sup>
Safety Integrity Level	SIL 3 / SILCL 3 <b>[7]</b>
Mission time	20 y

**[1]** With short circuit and overload protection

**[2]** In cross-section

**[3]** Optional: adjustable holders

**[4]** Self-diagnostics and status

**[5]** Acc. to EN 61496-1

**[6]** acc. to EN ISO 13849-1

**[7]** According to IEC 61508-1...4 / IEC 62061

### Dimension drawing

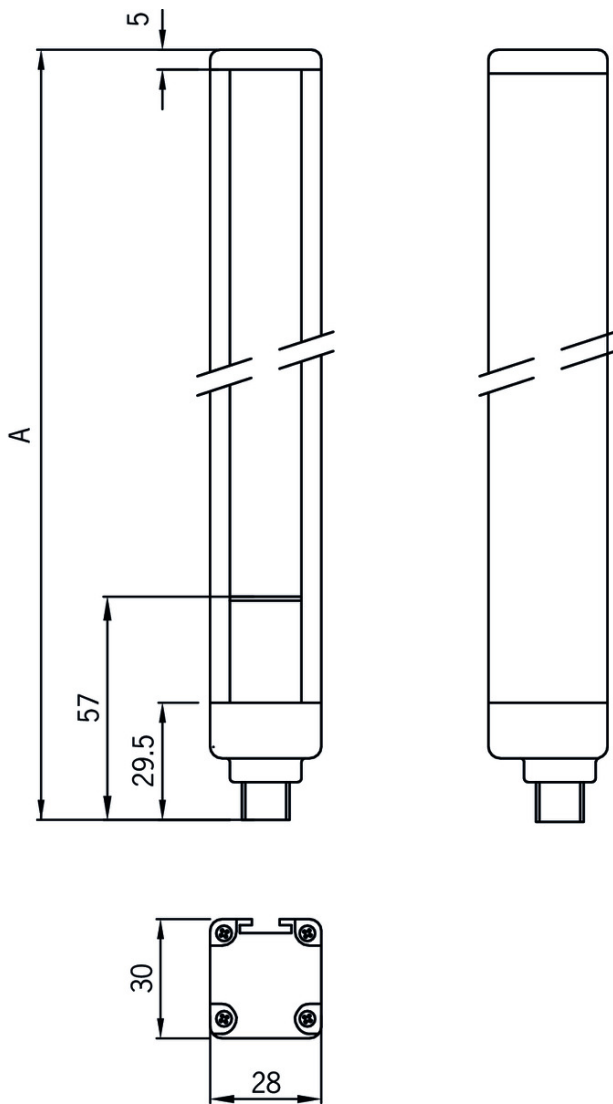

### Legende

A = Height of the sensor (see technical data)

### Wiring diagram receiver

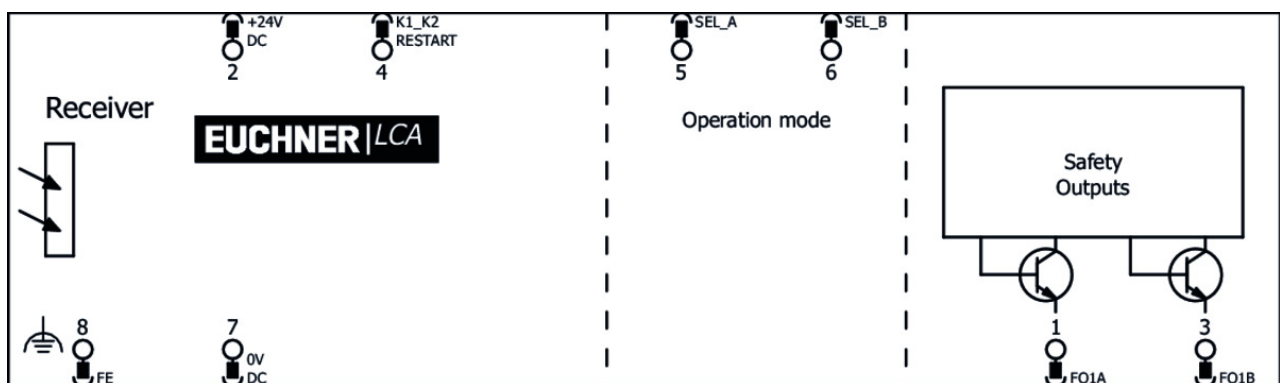

## Wiring diagram transmitter

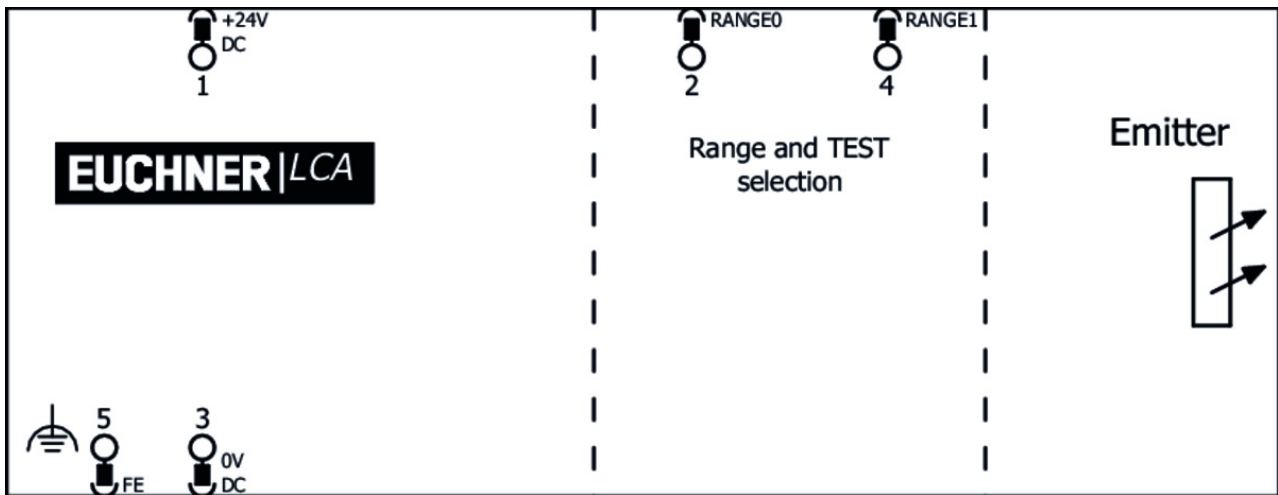

## Mounting accessories

- ✓ Socket for mounting pillars 202 x 224 x 55 mm



**156884** AM-OS-P-AA-156884

### ✓ Features

- › Socket for mounting pillars
- › Spring-mounted floor plate made of steel
- › Improved compensation of unevenness
- › Adjustable via adjusting screws
- › Height 55 mm

- ✓ Socket for mounting pillars 202 x 224 x 34 mm



**156885** AM-OS-P-AB-156885

### ✓ Features

- › Socket for mounting pillars
- › Adjustable via adjusting screws
- › Height 34 mm

- ✓ Mounting pillar for protective field heights from 760 - 1060 mm or 3 - 4 beam light grids



**156887** AM-OS-C-A1-1200-156887

### ✓ Features

- › Mounting pillar for light grids and light curtains LCA
- › For protective field heights from 760 - 1060 mm or 3 - 4 beams
- › Protects against damage
- › Straightforward adjustment using spherical circular level in the cover

- ✓ Mounting pillar with cable gland for protective field heights from 760 - 1060 mm or 3 - 4 beam light grids



**156891** AM-OS-C-A1-M-1200-156891

### ✓ Features

- › Mounting pillar for light grids and light curtains LCA
  - › For protective field heights from 760 - 1060 mm or for 3 - 4 beams
  - › With integrated cable gland PG11
  - › Protects against damage
  - › Straightforward adjustment using spherical circular level in the cover
- 

- ▼ 8 x vibration damper for protective field heights from 310 - 1,060 mm



**156917** AM-OS-D-V08-156917

▼ Features

- › Vibration damper for light grids and light curtains LCA
  - › For protective field heights 310 - 1060 mm
  - › Packaging unit 8 pcs.
  - › For reducing vibration
  - › Protects against damage
  - › Installation either on the product or on mounting pillar
- 

- ▼ 4 x adjustable holder



**156919** AM-OS-B-A1-V04-156919

▼ Features

- › Set of 4 holders for light grids and light curtains LCA
  - › For protective field heights up to 1210 mm
  - › Adjustable horizontally / vertically
  - › Quick mount using two screws
  - › Can be mounted directly on LCA
- 

- ▼ 4 x adjustable holder 180°



**156921** AM-OS-B-A2-V04-156921

▼ Features

- › Set of 4 holders for light grids and light curtains LCA
  - › Can be rotated by 180°
  - › Adjustable horizontally / vertically
  - › Quick mount using two screws
  - › Can be mounted directly on LCA
- 

## Function expansion

---

- ▼ Mounting pillar with deflection mirror for protective field heights from 760 - 910 mm or for 3 beam light grids



**156895** AE-OS-SC-1200-156895

▼ Features

- › Mounting pillar with deflection mirror for light grids and light curtains LCA
  - › For protective field heights from 760 - 910 mm or for 3 beams
  - › Protects against damage
  - › Straightforward adjustment using spherical circular level in the cover
- 

- ▼ Deflection mirror for protective field height 760 mm



### **156907** AE-OS-S-760-156907

#### ✓ Features

- › Deflection mirror with adjustable holder for light curtains LCA
- › For protective field height 760 mm

---

## Miscellaneous accessories

### ✓ Laser alignment aid



### **156915** AY-OS-LSR-156915

#### ✓ Features

- › Laser alignment aid for light grids and light curtains LCA
- › Light source: Laser diode – wavelength 650 nm
- › Laser class 2
- › Usable range 100 m
- › Straightforward clamping on the transmitter

### ✓ Test rod Ø 30 mm



### **156923** AY-OS-FTR-30-156923

#### ✓ Features

- › Test rod for light curtains LCA
- › Used for function test
- › Ø 30 mm
- › Cylinder with matt surface

---

## Connection material

### ✓ Connection cable with straight plug connector M12, 5-pin, 5m



### **100183** C-M12F05-05X034PV05,0-MA-100183

#### ✓ Features

- › M12 female plug, 5-pin
- › Straight plug connector
- › PVC cable
- › Cable length 5 m
- › With flying lead



### **113620** C-M12F05-05X034PU05,0-MA-113620

#### ✓ Features

- › M12 female plug, 5-pin
- › Straight plug connector
- › PUR cable
- › Cable length 5 m
- › With flying lead

### ✓ Connection cable with plug connector M12, 5-pin, 10m

### **100184** C-M12F05-05X034PV10,0-MA-100184





- ▼ Features
    - › M12 female plug, 5-pin
    - › Straight plug connector
    - › PVC cable
    - › Cable length 10 m
    - › With flying lead
- 

- ▼ Connection cable with plug connector M12, 5-pin, 20m



- ▼ **100185** C-M12F05-05X034PV20,0-MA-100185
  - ▼ Features
    - › M12 female plug, 5-pin
    - › Straight plug connector
    - › PVC cable
    - › Cable length 20 m
    - › With flying lead
- 

- ▼ Connection cable with straight plug connector M12, 5-pin, 10m



- ▼ **113640** C-M12F05-05X034PU10,0-MA-113640
  - ▼ Features
    - › M12 female plug, 5-pin
    - › Straight plug connector
    - › PUR cable
    - › Cable length 10 m
    - › With flying lead
- 

- ▼ Connection cable with straight plug connector M12, 5-pin, 20 m



- ▼ **113682** C-M12F05-05X034PU20,0-MA-113682
  - ▼ Features
    - › M12 female plug, 5-pin
    - › Straight plug connector
    - › PUR cable
    - › Cable length 20 m
    - › With flying lead
- 

- ▼ Connection cable with straight plug connector M12, 5-pin, 30 m



- ▼ **122784** C-M12F05-05X034PU30,0-MA-122784
  - ▼ Features
    - › M12 female plug, 5-pin
    - › Straight plug connector
    - › PUR cable
    - › Cable length 30 m
    - › With flying lead
- 

- ▼ Connection cable with 2 plug connectors M12, 5-pin, 5m



- ▼ **100180** C-M12F05-05X034PV05,0-M12M05-100180
- ▼ Features
  - › M12 female plug to M12 plug connector, 5-pin

- › Straight female plug and plug connector
- › PVC cable
- › Cable length 5 m



**119932** C-M12F05-05X034PU05,0-M12M05-119932

▣ Features

- › M12 female plug to M12 plug connector, 5-pin
- › Straight female plug and plug connector
- › PUR cable
- › Cable length 5 m

- 
- ▣ Connection cable with 2 plug connectors M12, 5-pin, 10m



**100181** C-M12F05-05X034PV10,0-M12M05-100181

▣ Features

- › M12 female plug to M12 plug connector, 5-pin
- › Straight female plug and plug connector
- › PVC cable
- › Cable length 10 m



**119947** C-M12F05-05X034PU10,0-M12M05-119947

▣ Features

- › M12 female plug to M12 plug connector, 5-pin
- › Straight female plug and plug connector
- › PUR cable
- › Cable length 10 m

- 
- ▣ Connection cable with 2 plug connectors M12, 5-pin, 20m



**100182** C-M12F05-05X034PV20,0-M12M05-100182

▣ Features

- › M12 female plug to M12 plug connector, 5-pin
- › Straight female plug and plug connector
- › PVC cable
- › Cable length 20 m



**119971** C-M12F05-05X034PU20,0-M12M05-119971

▣ Features

- › M12 female plug to M12 plug connector, 5-pin
- › Straight female plug and plug connector
- › PUR cable
- › Cable length 20 m

- 
- ▣ Connection cable with plug connector M12, 8-pin, 5m



**100177** C-M12F08-08X025PV05,0-MA-100177

▣ Features

- › M12 female plug, 8-pin
- › Straight plug connector
- › PVC cable
- › Cable length 5 m
- › With flying lead



**115112** C-M12F08-08X025PU05,0-MA-115112

▼ Features

- › M12 female plug, 8-pin
- › Straight plug connector
- › PUR cable
- › Cable length 5 m
- › With flying lead

▼ Connection cable with plug connector M12, 8-pin, 10m



**100178** C-M12F08-08X025PV10,0-MA-100178

▼ Features

- › M12 female plug, 8-pin
- › Straight plug connector
- › PVC cable
- › Cable length 10 m
- › With flying lead



**115113** C-M12F08-08X025PU10,0-MA-115113

▼ Features

- › M12 female plug, 8-pin
- › Straight plug connector
- › PUR cable
- › Cable length 10 m
- › With flying lead

▼ Connection cable with plug connector M12, 8-pin, 20m



**100179** C-M12F08-08X025PV20,0-MA-100179

▼ Features

- › M12 female plug, 8-pin
- › Straight plug connector
- › PVC cable
- › Cable length 20 m
- › With flying lead



**115114** C-M12F08-08X025PU20,0-MA-115114

▼ Features

- › M12 female plug, 8-pin
- › Straight plug connector
- › PUR cable
- › Cable length 20 m
- › With flying lead

▼ Connection cable with plug connector M12, 8-pin, 30m



**115116** C-M12F08-08X025PV30,0-MA-115116

▼ Features

- › M12 female plug, 8-pin
- › Straight plug connector
- › PVC cable

- › Cable length 30 m
- › With flying lead



**115257** C-M12F08-08X025PU30,0-MA-115257

✓ Features

- › M12 female plug, 8-pin
- › Straight plug connector
- › PUR cable
- › Cable length 30 m
- › With flying lead

✓ Connection cable with 2 plug connectors M12, 1m



**123430** C-M12M08-08X025PV01,0-M12F08-123430

✓ Features

- › 8-pin M12 male plug, straight
- › 8-pin M12 female connector, straight
- › PVC cable
- › Cable length 1m

✓ Connection cable with 2 plug connectors M12, 2m



**123431** C-M12M08-08X025PV02,0-M12F08-123431

✓ Features

- › 8-pin M12 male plug, straight
- › 8-pin M12 female connector, straight
- › PVC cable
- › Cable length 2m

✓ Connection cable with 2 plug connectors M12, 5m



**123432** C-M12M08-08X025PV05,0-M12F08-123432

✓ Features

- › 8-pin M12 male plug, straight
- › 8-pin M12 female connector, straight
- › PVC cable
- › Cable length 5m

✓ Connection cable with 2 plug connectors M12, 10m









**123433** C-M12M08-08X025PV10,0-M12F08-123433

✓ Features

- › 8-pin M12 male plug, straight
- › 8-pin M12 female connector, straight
- › PVC cable
- › Cable length 10m









## Instructions

### Manual de instrucciones Barreras/cortinas fotoeléctricas LCA 4

	Doc. no.	Version	Language	Download
Betriebsanleitung Lichtgitter/ Lichtvorhänge LCA 4 Operating Instructions Light Grids/ Light Curtains LCA 4	2504709	02-02/18	 	 5.2 MB
Mode d'emploi Barrières photoélectriques / rideaux lumineux LCA 4	2504709	02-02/18		 3.1 MB
Manual de instrucciones Barreras/cortinas fotoeléctricas LCA 4	2504709	02-02/18		 3.1 MB







## Catalogs

### Light grids and light curtains LCA Barreras fotoeléctricas y cortinas fotoeléctricas LCA Barrières photoélectriques et rideaux lumineux LCA Lichtgitter und Lichtvorhänge LCA

	Doc. no.	Version	Language	Download
Lichtgitter und Lichtvorhänge LCA	157084	03-03/18		 2.5 MB
Barrières photoélectriques et rideaux lumineux LCA	157086	03-03/18		 2.5 MB
Barreras fotoeléctricas y cortinas fotoeléctricas LCA	157087	03-03/18		 2.5 MB
Light grids and light curtains LCA	157085	03-03/18		 2.5 MB

## Declaration of conformity

### EU-Konformitätserklärung

	Doc. no.	Version	Language	Download
EU-Konformitätserklärung Declaración UE de conformidad Déclaration UE de conformité Dichiarazione di conformità EU declaration of conformity	2503625	02-08/17	    	 0.2 MB