

ITEM 156520 LCA-4TR-30-1360-AP-156520

Description	Technical data	Accessories	Downloads
-------------	----------------	-------------	-----------



Features

- › Resolution 30 mm
- › Protective field height 1,360 mm
- › Range 12 m
- › With plug connector M12
- › Two safety outputs (OSSD)
- › Installation material is included with the product

Protective function



- › Figure
hand protection

LED function display



► Figure
Transmitter



► Figure
Receiver

- LED OK** Normal operation
- LED ERROR** Fault state
- LED STOP** Stop state
- LED TEST** Test function
- LED START** Start/ restart

Pin assignment transmitter

Plug connector (view of connection side)	Pin	Designation	Function	Conductor coloring of connection cable
	1	24 V DC	Operating voltage, 24 V DC	BN
	2	RANGE 0	Device configuration, corresponds to the standard EN 61131-2	WH
	3	0 V DC	Operating voltage, 0 V DC	BU
	4	RANGE 1	Device configuration, corresponds to the standard EN 61131-2	BK
	5	FE	Function earth (must be connected to meet the EMC requirements)	GY

Connector assignment receiver

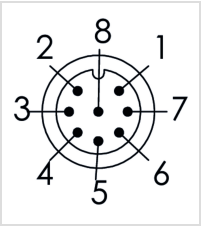
Plug connector (view of connection side)	Pin	Designation	Function	Conductor coloring of connection cable
	1	FO1A	Safety output, channel 1	WH
	2	24 V DC	Operating voltage, 24 V DC	BN
	3	FO1B	Safety output, channel 2	GN
	4	K1_K2/RESTART	Feedback external contactors	YE
	5	SEL_A	Device configuration	GY
	6	SEL_B	Device configuration	PK
	7	0 V DC	Operating voltage, 0 V DC	BU
	8	FE	Function earth (must be connected to meet the EMC requirements)	RD

Approvals



Mechanical values and environment

Number of safety outputs	2 Static, self-monitoring PNP safety outputs [1]
Resolution	30 mm
Height of the protective field	1360 mm
Height of the sensor	1413 mm
Maximum length of connection cables	100 m
Range of the protective field	12000 mm
Dimensions	28x30 mm [2]
Ambient temperature	-30 ... 55 °C
Degree of protection	IP 65 / IP 67
Installation position	Any [3]
Reaction time	17 ms
Connection	Plug connector M12 (5-pin transmitter / 8-pin receiver)

Electrical connection ratings

Cascadable	No
------------	----

Muting possible	In combination with external sensors and an evaluation unit
Operating voltage DC	24 V DC -20% ... +20%
Current consumption	400 mA
Power consumption	
	Transmitter 1 W
	Receiver 2 W
LED indicator	Yes [4]

Reliability values acc. to EN ISO 13849-1

ESPE type	4 [5]
Performance Level	PL e [6]
PFH _D	1,80x10 ⁻⁸
Safety Integrity Level	SIL 3 / SILCL 3 [7]
Mission time	20 y

[1] With short circuit and overload protection

[2] In cross-section

[3] Optional: adjustable holders

[4] Self-diagnostics and status

[5] Acc. to EN 61496-1

[6] acc. to EN ISO 13849-1

[7] According to IEC 61508-1...4 / IEC 62061

Dimension drawing

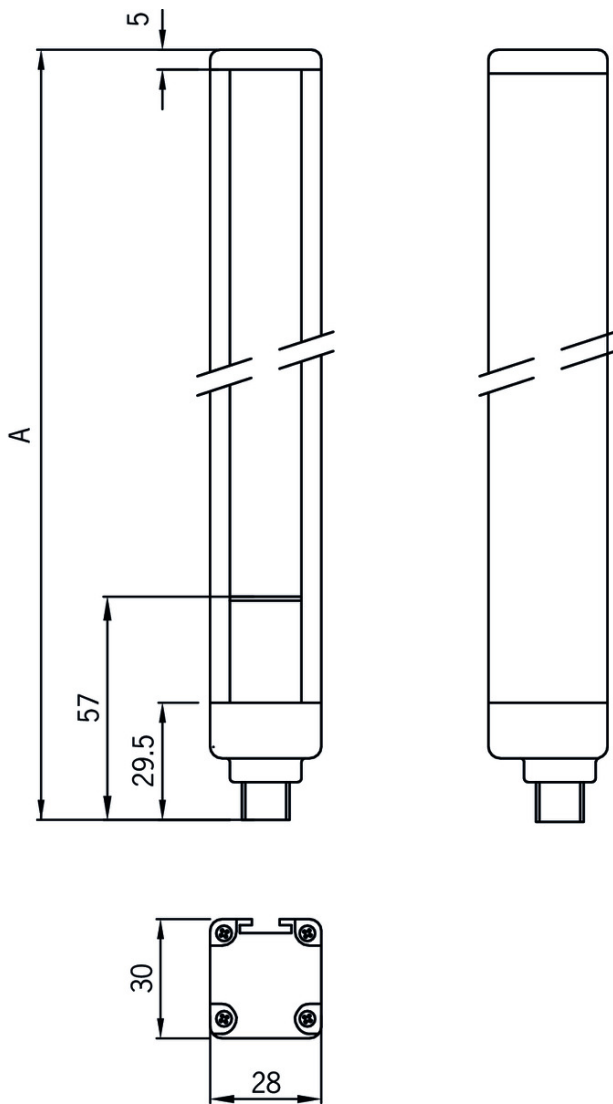

Legende

A = Height of the sensor (see technical data)

Wiring diagram transmitter

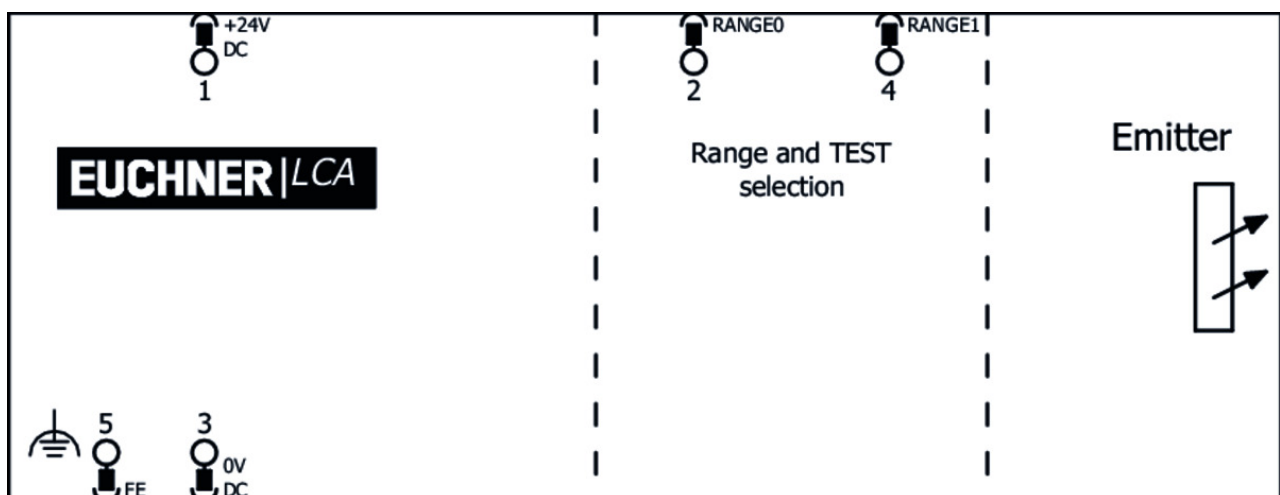

Wiring diagram receiver

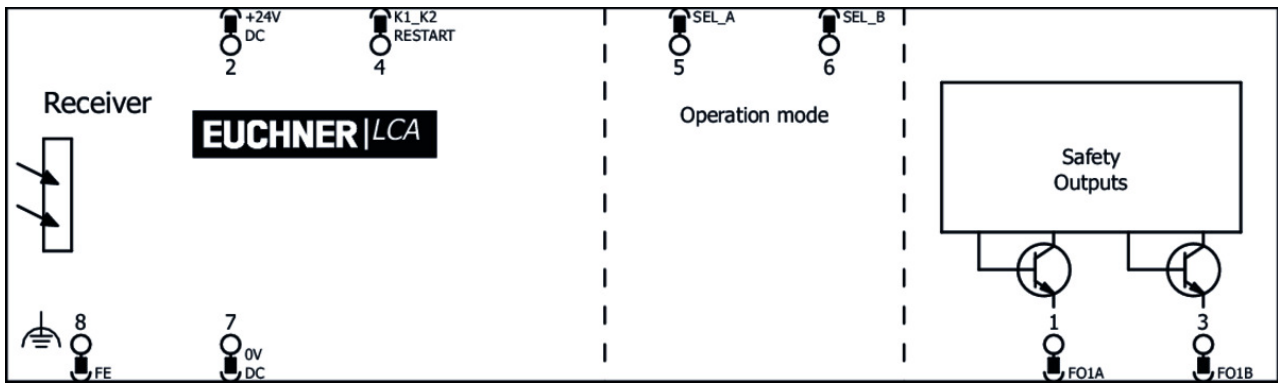

Mounting accessories

- Socket for mounting pillars 202 x 224 x 55 mm



156884 AM-OS-P-AA-156884

Features

- Socket for mounting pillars
- Spring-mounted floor plate made of steel
- Improved compensation of unevenness
- Adjustable via adjusting screws
- Height 55 mm

- Socket for mounting pillars 202 x 224 x 34 mm



156885 AM-OS-P-AB-156885

Features

- Socket for mounting pillars
- Adjustable via adjusting screws
- Height 34 mm

- Mounting pillar for protective field heights from 1210 to 1360 mm



156888 AM-OS-C-A1-1670-156888

Features

- Mounting pillar for light grids and light curtains LCA
- For protective field heights from 1210 to 1360 mm
- Protects against damage
- Straightforward adjustment using spherical circular level in the cover

- Mounting pillar with cable gland for protective field heights from 1210 to 1360 mm



156892 AM-OS-C-A1-M-1670-156892

Features

- Mounting pillar for light grids and light curtains LCA
- For protective field heights from 1210 to 1360 mm
- With integrated cable gland PG11
- Protects against damage
- Straightforward adjustment using spherical circular level in the cover

-
- ▼ 12 x vibration damper for protective field heights of 1,210 to 1,810 mm or 2- to 4-beam light grids



156918 AM-OS-D-V12-156918

▼ Features

- › Vibration damper for light grids and light curtains LCA
- › For protective field heights 1210 - 1810 mm or 2- 4 beams
- › Packaging unit 12 pcs.
- › For reducing vibration
- › Protects against damage
- › Installation either on the product or on mounting pillar

-
- ▼ 6 x adjustable holder



156920 AM-OS-B-A1-V06-156920

▼ Features

- › Set of 6 holders for light grids and light curtains LCA
- › For protective field heights from 1210 mm
- › Adjustable horizontally / vertically
- › Quick mount using two screws
- › Can be mounted directly on LCA

-
- ▼ 4 x adjustable holder 180°



156921 AM-OS-B-A2-V04-156921

▼ Features

- › Set of 4 holders for light grids and light curtains LCA
- › Can be rotated by 180°
- › Adjustable horizontally / vertically
- › Quick mount using two screws
- › Can be mounted directly on LCA

Function expansion

- ▼ Mounting pillar with deflection mirror for protective field heights from 1060 to 1360 mm



156897 AE-OS-SC-1670-156897

▼ Features

- › Mounting pillar with deflection mirror for light grids and light curtains LCA
- › For protective field heights from 1060 to 1360 mm
- › Protects against damage
- › Straightforward adjustment using spherical circular level in the cover

-
- ▼ Deflection mirror for protective field height 1360 mm



156911 AE-OS-S-1360-156911

▼ Features

- › Deflection mirror with adjustable holder for light curtains LCA
- › For protective field height 1360 mm

Miscellaneous accessories

▾ Laser alignment aid



156915 AY-OS-LSR-156915

▾ Features

- › Laser alignment aid for light grids and light curtains LCA
- › Light source: Laser diode – wavelength 650 nm
- › Laser class 2
- › Usable range 100 m
- › Straightforward clamping on the transmitter

▾ Test rod Ø 30 mm



156923 AY-OS-FTR-30-156923

▾ Features

- › Test rod for light curtains LCA
- › Used for function test
- › Ø 30 mm
- › Cylinder with matt surface

Connection material

▾ Connection cable with straight plug connector M12, 5-pin, 5m



100183 C-M12F05-05X034PV05,0-MA-100183

▾ Features

- › M12 female plug, 5-pin
- › Straight plug connector
- › PVC cable
- › Cable length 5 m
- › With flying lead



113620 C-M12F05-05X034PU05,0-MA-113620

▾ Features

- › M12 female plug, 5-pin
- › Straight plug connector
- › PUR cable
- › Cable length 5 m
- › With flying lead

▾ Connection cable with plug connector M12, 5-pin, 10m



100184 C-M12F05-05X034PV10,0-MA-100184

▾ Features

- › M12 female plug, 5-pin
- › Straight plug connector
- › PVC cable
- › Cable length 10 m
- › With flying lead

-
- ▼ Connection cable with plug connector M12, 5-pin, 20m



100185 C-M12F05-05X034PV20,0-MA-100185

▼ Features

- › M12 female plug, 5-pin
 - › Straight plug connector
 - › PVC cable
 - › Cable length 20 m
 - › With flying lead
-

- ▼ Connection cable with straight plug connector M12, 5-pin, 10m



113640 C-M12F05-05X034PU10,0-MA-113640

▼ Features

- › M12 female plug, 5-pin
 - › Straight plug connector
 - › PUR cable
 - › Cable length 10 m
 - › With flying lead
-

- ▼ Connection cable with straight plug connector M12, 5-pin, 20 m



113682 C-M12F05-05X034PU20,0-MA-113682

▼ Features

- › M12 female plug, 5-pin
 - › Straight plug connector
 - › PUR cable
 - › Cable length 20 m
 - › With flying lead
-

- ▼ Connection cable with straight plug connector M12, 5-pin, 30 m



122784 C-M12F05-05X034PU30,0-MA-122784

▼ Features

- › M12 female plug, 5-pin
 - › Straight plug connector
 - › PUR cable
 - › Cable length 30 m
 - › With flying lead
-

- ▼ Connection cable with 2 plug connectors M12, 5-pin, 5m



100180 C-M12F05-05X034PV05,0-M12M05-100180

▼ Features

- › M12 female plug to M12 plug connector, 5-pin
 - › Straight female plug and plug connector
 - › PVC cable
 - › Cable length 5 m
-

119932 C-M12F05-05X034PU05,0-M12M05-119932



- ✓ Features
 - › M12 female plug to M12 plug connector, 5-pin
 - › Straight female plug and plug connector
 - › PUR cable
 - › Cable length 5 m
-

✓ Connection cable with 2 plug connectors M12, 5-pin, 10m



- 100181** C-M12F05-05X034PV10,0-M12M05-100181
- ✓ Features
 - › M12 female plug to M12 plug connector, 5-pin
 - › Straight female plug and plug connector
 - › PVC cable
 - › Cable length 10 m
-



- 119947** C-M12F05-05X034PU10,0-M12M05-119947
- ✓ Features
 - › M12 female plug to M12 plug connector, 5-pin
 - › Straight female plug and plug connector
 - › PUR cable
 - › Cable length 10 m
-

✓ Connection cable with 2 plug connectors M12, 5-pin, 20m



- 100182** C-M12F05-05X034PV20,0-M12M05-100182
- ✓ Features
 - › M12 female plug to M12 plug connector, 5-pin
 - › Straight female plug and plug connector
 - › PVC cable
 - › Cable length 20 m
-



- 119971** C-M12F05-05X034PU20,0-M12M05-119971
- ✓ Features
 - › M12 female plug to M12 plug connector, 5-pin
 - › Straight female plug and plug connector
 - › PUR cable
 - › Cable length 20 m
-

✓ Connection cable with plug connector M12, 8-pin, 5m



- 100177** C-M12F08-08X025PV05,0-MA-100177
- ✓ Features
 - › M12 female plug, 8-pin
 - › Straight plug connector
 - › PVC cable
 - › Cable length 5 m
 - › With flying lead
-



- 115112** C-M12F08-08X025PU05,0-MA-115112
- ✓ Features
 - › M12 female plug, 8-pin

- › Straight plug connector
 - › PUR cable
 - › Cable length 5 m
 - › With flying lead
-

▼ Connection cable with plug connector M12, 8-pin, 10m



100178 C-M12F08-08X025PV10,0-MA-100178

▼ Features

- › M12 female plug, 8-pin
 - › Straight plug connector
 - › PVC cable
 - › Cable length 10 m
 - › With flying lead
-



115113 C-M12F08-08X025PU10,0-MA-115113

▼ Features

- › M12 female plug, 8-pin
 - › Straight plug connector
 - › PUR cable
 - › Cable length 10 m
 - › With flying lead
-

▼ Connection cable with plug connector M12, 8-pin, 20m



100179 C-M12F08-08X025PV20,0-MA-100179

▼ Features

- › M12 female plug, 8-pin
 - › Straight plug connector
 - › PVC cable
 - › Cable length 20 m
 - › With flying lead
-



115114 C-M12F08-08X025PU20,0-MA-115114

▼ Features

- › M12 female plug, 8-pin
 - › Straight plug connector
 - › PUR cable
 - › Cable length 20 m
 - › With flying lead
-

▼ Connection cable with plug connector M12, 8-pin, 30m



115116 C-M12F08-08X025PV30,0-MA-115116

▼ Features

- › M12 female plug, 8-pin
 - › Straight plug connector
 - › PVC cable
 - › Cable length 30 m
 - › With flying lead
-

115257 C-M12F08-08X025PU30,0-MA-115257



- ▼ Features
 - › M12 female plug, 8-pin
 - › Straight plug connector
 - › PUR cable
 - › Cable length 30 m
 - › With flying lead
-

- ▼ Connection cable with 2 plug connectors M12, 1m



- 123430** C-M12M08-08X025PV01,0-M12F08-123430
 - ▼ Features
 - › 8-pin M12 male plug, straight
 - › 8-pin M12 female connector, straight
 - › PVC cable
 - › Cable length 1m
-

- ▼ Connection cable with 2 plug connectors M12, 2m



- 123431** C-M12M08-08X025PV02,0-M12F08-123431
 - ▼ Features
 - › 8-pin M12 male plug, straight
 - › 8-pin M12 female connector, straight
 - › PVC cable
 - › Cable length 2m
-

- ▼ Connection cable with 2 plug connectors M12, 5m



- 123432** C-M12M08-08X025PV05,0-M12F08-123432
 - ▼ Features
 - › 8-pin M12 male plug, straight
 - › 8-pin M12 female connector, straight
 - › PVC cable
 - › Cable length 5m
-







- ▼ Connection cable with 2 plug connectors M12, 10m



- 123433** C-M12M08-08X025PV10,0-M12F08-123433
 - ▼ Features
 - › 8-pin M12 male plug, straight
 - › 8-pin M12 female connector, straight
 - › PVC cable
 - › Cable length 10m
-









Instructions

- ▼ Manual de instrucciones Barreras/cortinas fotoeléctricas LCA 4

Betriebsanleitung Lichtgitter/ Lichtvorhänge LCA 4 Operating Instructions Light Grids/ Light Curtains LCA 4	2504709	02-02/18	 	 5.2 MB
Mode d'emploi Barrières photoélectriques / rideaux lumineux LCA 4	2504709	02-02/18		 3.1 MB
Manual de instrucciones Barreras/cortinas fotoeléctricas LCA 4	2504709	02-02/18		 3.1 MB







Catalogs

- Light grids and light curtains LCA Barreras fotoeléctricas y cortinas fotoeléctricas LCA Barrières photoélectriques et rideaux lumineux LCA Lichtgitter und Lichtvorhänge LCA

	Doc. no.	Version	Language	Download
Lichtgitter und Lichtvorhänge LCA	157084	03-03/18		 2.5 MB
Barrières photoélectriques et rideaux lumineux LCA	157086	03-03/18		 2.5 MB
Barreras fotoeléctricas y cortinas fotoeléctricas LCA	157087	03-03/18		 2.5 MB
Light grids and light curtains LCA	157085	03-03/18		 2.5 MB

Declaration of conformity

- EU-Konformitätserklärung

	Doc. no.	Version	Language	Download
EU-Konformitätserklärung Declaración UE de conformidad Déclaration UE de conformité Dichiarazione di conformità EU declaration of conformity	2503625	02-08/17	    	 0.2 MB